

QUALITY ASSURANCE/QUALITY CONTROL DOCUMENTATION SERIES	
TITLE	TRANSMISSOMETER MAINTENANCE (IMPROVE PROTOCOL)
TYPE	STANDARD OPERATING PROCEDURE
NUMBER	4110
DATE	OCTOBER 1993

AUTHORIZATIONS		
TITLE	NAME	SIGNATURE
ORIGINATOR	Gloria S. Mercer	
PROJECT MANAGER	Mark Tigges	
PROGRAM MANAGER	David L. Dietrich	
QA MANAGER	Gloria S. Mercer	
OTHER		

REVISION HISTORY			
REVISION NO.	CHANGE DESCRIPTION	DATE	AUTHORIZATIONS
0.1	Minor text changes.	August 1996	
	Reviewed; no changes necessary.	August 1997	
	Reviewed; no changes necessary.	August 1998	
	Reviewed; no changes necessary.	August 1999	
	Reviewed; no changes necessary.	August 2000	
0.2	Delete references to Primeline recorders.	August 2001	
	Reviewed; no changes necessary.	August 2002	
	-- continued --		

QUALITY ASSURANCE/QUALITY CONTROL DOCUMENTATION SERIES	
TITLE	TRANSMISSOMETER MAINTENANCE (IMPROVE PROTOCOL)
TYPE	STANDARD OPERATING PROCEDURE
NUMBER	4110
DATE	OCTOBER 1993

AUTHORIZATIONS		
TITLE	NAME	SIGNATURE
ORIGINATOR	Gloria S. Mercer	
PROJECT MANAGER	Mark Tigges	
PROGRAM MANAGER	David L. Dietrich	
QA MANAGER	Gloria S. Mercer	
OTHER		

REVISION HISTORY			
REVISION NO.	CHANGE DESCRIPTION	DATE	AUTHORIZATIONS
0.3	Revised flowchart.	October 2003	
	Reviewed; no changes necessary.	October 2004	

TABLE OF CONTENTS

<u>Section</u>	<u>Page</u>
1.0 PURPOSE AND APPLICABILITY	1
2.0 RESPONSIBILITIES	3
2.1 Project Manager	3
2.2 Data Coordinator	3
2.3 Instrument Technician	3
2.4 Field Specialist	4
2.5 Site Operator	4
3.0 REQUIRED EQUIPMENT AND MATERIALS	4
3.1 Routine Field Maintenance	4
3.2 Troubleshooting and Emergency Maintenance	4
3.3 Annual Laboratory Maintenance	5
3.4 Inventory	5
4.0 METHODS	5
4.1 Description of Transmissometer Components	5
4.1.1 Transmitter	7
4.1.2 Receiver	7
4.2 Routine Site Operator Maintenance	8
4.3 Emergency Maintenance and Troubleshooting	9
4.4 Annual Site Visit	9
4.5 Annual Laboratory Maintenance	10

LIST OF FIGURES

<u>Figure</u>	<u>Page</u>
4-1 Typical Transmissometer Configuration – IMPROVE Network	6
4-2 Annual Service Procedure for Optec LPV-2 Transmissometers	12

1.0 PURPOSE AND APPLICABILITY

This standard operating procedure (SOP) outlines and describes the components of a comprehensive program for operating and maintaining the Optec LPV-2 transmissometer. The purpose of this program is to provide detailed operations and maintenance procedures that will assure quality data capture and minimize data loss.

The LPV-2 transmissometer is manufactured by Optec, Inc. The instrument has evolved to its present configuration as a result of the visibility monitoring needs defined by the National Park Service (NPS) Visibility Monitoring and Data Analysis Program and the Interagency Monitoring of Protected Visual Environments (IMPROVE) Committee.

The LPV-2 meets the following criteria:

- Measures the light transmission properties of the atmosphere both day and night at 550 nanometers or other preselected wavelengths.
- Provides a variety of sampling and averaging options.
- Directly integrates scattering and absorbing properties of aerosols and gases in the selected sight path; these transmission measurements have an exact relationship to the total atmospheric extinction coefficient.
- Operates unattended for extended periods.
- Operates at low power, 12-volt D.C. for remote and solar installations.
- Operates at ambient temperatures.
- Is modular, lightweight, and easily transported.
- Is easily serviced.

The first LPV-2 was installed in August 1986. Since that time, the instrument has become the standard against which other visibility monitoring techniques have been compared.

The Optec LPV-2 transmissometer measures the ability of the atmosphere to transmit light of a specific wavelength (generally 550 nm, green). It accomplishes this by continuously measuring the loss in light received from a light source of known intensity as the light beam travels a known distance. Unlike nephelometers, which only measure the scattering component of total extinction at a point source, the LPV-2 measures total extinction by integrating the light scattering and absorbing properties of the atmosphere along a selected sight path.

The LPV-2 transmissometer has two primary components: a light source (transmitter), and a light detector (receiver). Depending on the expected range of visual air quality, the two components are generally placed from 0.5 to 10 kilometers apart. The system can take measurements day and night because the light emitted from the transmitter is “chopped” at 78

pulses a second to allow the receiver to differentiate the lamp signal from background, ambient lighting. The receiver-measured transmitter light intensity is compared to the known (calibrated) transmitter light output to calculate the percent transmission of the atmosphere. When the path distance is supplied, the receiver computer can calculate the express visibility measurements in terms of extinction (km^{-1}) or visual range (km).

The LPV-2 transmissometer system's low power consumption permits remote operation from a small supply, such as a solar power system. Both components have self-resetting, battery-backup circuitry to accommodate extended periods of unattended operation. Both components operate at ambient temperatures, but require sheltering from precipitation and dirt. Routine servicing of the system can be performed by trained, non-technical personnel. Instrument calibration, generally performed annually, and repair requires trained technical personnel or factory-authorized service.

The Optec LPV-2 operations and maintenance quality assurance program consists of four (4) major categories:

- Routine site operator maintenance
- Troubleshooting and emergency maintenance
- Annual site visit
- Annual maintenance

Detailed descriptions of the procedures to be followed in performing specific maintenance tasks referenced in this SOP are provided in the following SOPs and technical instructions (TIs):

- TI 4110-3100, *Routine Site Operator Maintenance Procedures for Optec LPV-2 Transmissometer Systems (IMPROVE Protocol)*
- TI 4110-3300, *Troubleshooting and Emergency Maintenance Procedures for Optec LPV-2 Transmissometer Systems (IMPROVE Protocol)*
- TI 4110-3350, *Transmissometer Monitoring System Diagrams and Component Descriptions*
- TI 4110-3375, *Replacing and Shipping Transmissometer Components*
- TI 4110-3400, *Annual Laboratory Maintenance Procedures for Optec LPV-2 Transmissometer Systems (IMPROVE Protocol)*
- SOP 4115, *Annual Site Visits for Optical Monitoring Instrumentation (IMPROVE Protocol)*
- TI 4115-3000, *Annual Site Visit Procedures for Optec LPV-2 Transmissometer Systems (IMPROVE Protocol)*
- SOP 4710, *Transmissometer Field Audit Procedures*

2.0 RESPONSIBILITIES

2.1 PROJECT MANAGER

The project manager shall:

- Oversee the activities of the data coordinator, instrument technician, and field specialist.
- Oversee and review site operator documentation.
- Oversee and review instrument maintenance records.
- Review routine and emergency maintenance and troubleshooting plans with the data coordinator, field specialist, and instrument technician as required.
- Review and approve any changes to maintenance procedures.

2.2 DATA COORDINATOR

The data coordinator shall:

- Coordinate site operator activities and schedules.
- Review site operator documentation.
- Provide technical support to the site operator.
- Initiate emergency maintenance and troubleshooting plans in response to transmissometer system malfunctions.
- Coordinate replacement of malfunctioning equipment.
- Document all communications with the site operator.

2.3 INSTRUMENT TECHNICIAN

The instrument technician shall:

- Perform annual servicing of transmissometers and associated support equipment.
- Repair damaged or malfunctioning transmissometers and associated support equipment.
- Maintain an inventory of spare parts and servicing supplies.
- Provide technical support to the site operator and data coordinator and/or field specialist.
- Document all service and repair work performed to transmissometers and transmissometer system support equipment.

2.4 FIELD SPECIALIST

The field specialist shall:

- Coordinate maintenance schedules with the project manager, data coordinator, and site operator.
- Provide technical support to the site operator and/or data coordinator as required.
- Perform field repair or replacement of transmissometer system components.
- Train the site operator in routine and emergency maintenance procedures.

2.5 SITE OPERATOR

The site operator shall:

- Perform routine transmissometer system service and maintenance tasks.
- Perform troubleshooting and emergency maintenance tasks as directed by the data coordinator or field specialist.
- Document all on-site service, troubleshooting and maintenance work performed.

3.0 REQUIRED EQUIPMENT AND MATERIALS

ARS will maintain a sufficient inventory of spare components and repair parts to accommodate routine and emergency maintenance of the Optec LPV-2 transmissometer and associated support equipment.

3.1 ROUTINE FIELD MAINTENANCE

Routine maintenance requires a small set of standard mechanical tools (screwdrivers, wrenches, etc.), a 3½ digit digital voltmeter, and cleaning supplies. A detailed list of equipment and materials for routine maintenance is provided in TI 4110-3100, *Routine Site Operator Maintenance Procedures for Optec LPV-2 Transmissometer Systems (IMPROVE Protocol)*.

3.2 TROUBLESHOOTING AND EMERGENCY MAINTENANCE

Troubleshooting and emergency maintenance normally requires the same equipment and materials as routine maintenance. Certain troubleshooting tasks may require specialized test fixtures or test instruments. These items are sent to the site operator on an as needed basis. A detailed list of equipment and materials for troubleshooting and emergency maintenance of the LPV-2 transmissometer system are provided in TI 4110-3300, *Troubleshooting and Emergency Maintenance Procedures for Optec LPV-2 Transmissometer Systems (IMPROVE Protocol)*.

3.3 ANNUAL LABORATORY MAINTENANCE

Annual laboratory maintenance requires a well-equipped electronics laboratory, an optical bench and associated optical fixtures, and a field test facility. A detailed list of equipment and materials needed for laboratory maintenance is provided in TI 4110-3400, *Annual Laboratory Maintenance Procedures for Optec LPV-2 Transmissometer Systems (IMPROVE Protocol)*.

3.4 INVENTORY

It is imperative that all capital instrumentation changes made as a result of routine and annual maintenance be thoroughly documented and maintained in the ARS Purchase Order/Inventory Database. Specific model and serial number items tracked are discussed further in the instrument-specific troubleshooting and emergency maintenance TIs.

4.0 METHODS

This section includes five (5) major subsections:

- 4.1 Description of Transmissometer Components
- 4.2 Routine Site Operator Maintenance
- 4.3 Emergency Maintenance and Troubleshooting
- 4.4 Annual Site Visit
- 4.5 Annual Laboratory Maintenance

Each transmissometer site is supplied with a *Site Operator's Manual for Transmissometer Monitoring Systems*. This manual includes SOPs and TIs applicable to site operator maintenance and manufacturer's instruction manuals for the LPV-2 transmissometer and associated support equipment.

4.1 DESCRIPTION OF TRANSMISSOMETER COMPONENTS

The LPV-2 transmissometer has two primary components: a light source (transmitter), and a light detector (receiver). Additional instrumentation and support equipment provided at transmissometer sites in the IMPROVE network generally includes:

- Instrument shelters.
- Handar data collection platform (DCP).
- Rotronics air temperature/relative humidity sensor.

Both the transmitter and receiver operate under ambient conditions but require waterproof sheltering. Figure 4-1 shows typical transmitter and receiver shelters as configured in the IMPROVE network.

The following subsections briefly describe the basic operation of the LPV-2 transmitter and receiver.

Receiver Station
 (6' x 6' x 8')

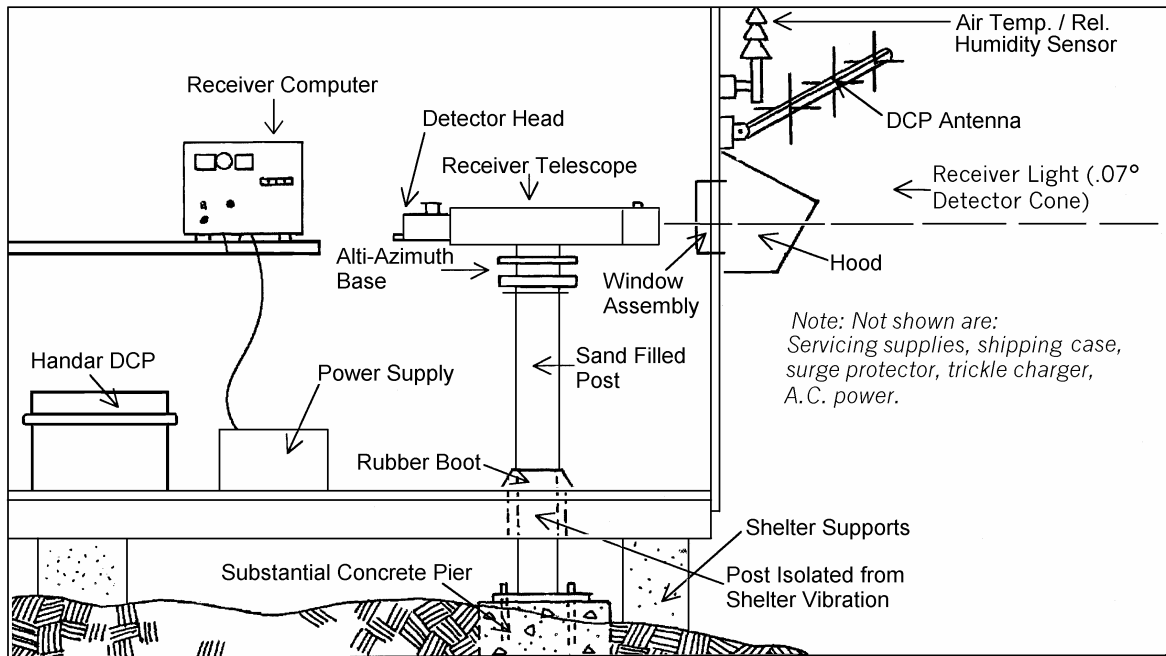

Transmitter Station
 (3' x 3' x 4'6")

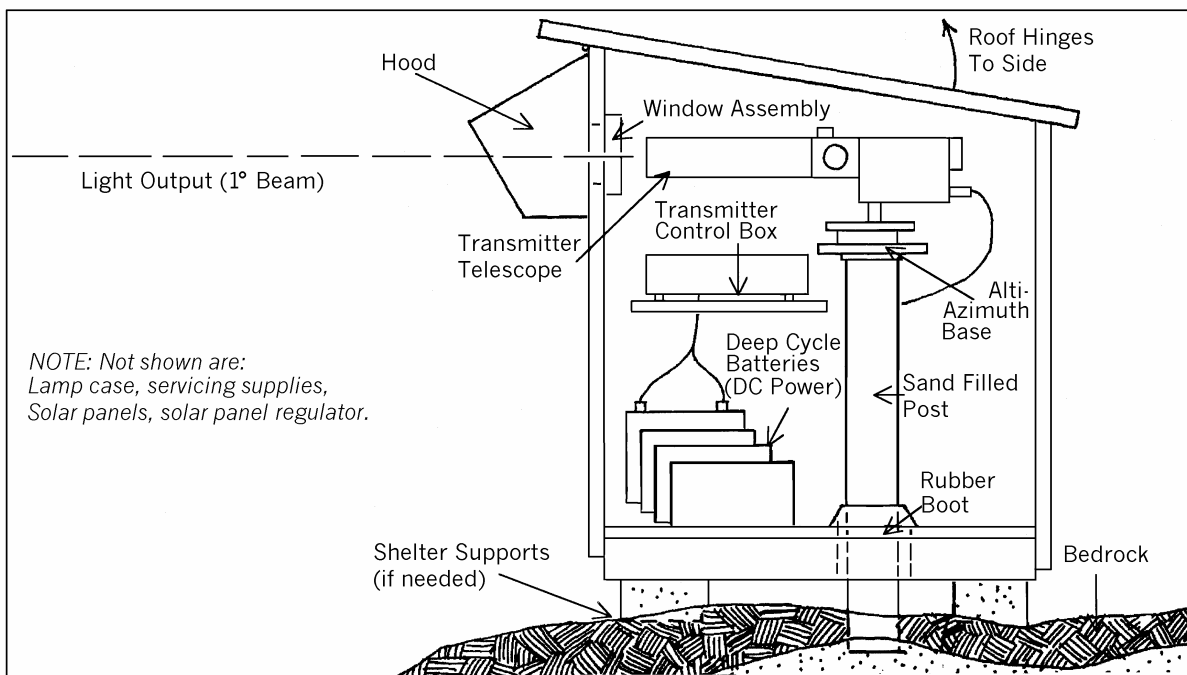

Figure 4-1. Typical Transmissometer Configuration - IMPROVE Network.

4.1.1 Transmitter

The LPV-2 transmitter emits a uniform, chopped, incandescent light beam of constant intensity at regular intervals for a programmed duration. The transmitter has two components: an electronic control box, and a light source or transmitter. The transmitter optics perform two functions:

- Concentrates light from the 15 watt tungsten filament lamp into a narrow, well-defined uniform cone, magnifying the beam to the equivalent of a 1500 watt lamp.
- Allows the operator to precisely aim the light at the receiver. Although a 1 degree cone of light is emitted from the transmitter, only the center 0.17 degree portion is used for routine monitoring. This portion of the beam is very uniform in illumination.

The intensity of the light emitted from the transmitter is precisely controlled by an optical feedback system, which continuously samples the center 0.17 degree portion of the outgoing beam and performs fine adjustments to keep the light output constant. Light emitted from the transmitter is “chopped” at 78 pulses a second by a mechanical spinning disk in front of the lamp. The light is chopped to allow the receiver computer to differentiate the lamp signal from background or ambient lighting. An eyepiece lets the operator precisely aim the light beam.

The transmissometer can be operated in either a continuous or cycled mode. In the continuous mode the transmitter projects the chopped signal continuously. To prolong lamp life, reduce power consumption, or to accommodate various sampling strategies, the transmitter can be operated in a cycled mode. In the cycled mode the transmitter is programmed on at precise intervals and stays on for selected durations.

IMPROVE network transmissometers operate in a cycled mode, with the transmitter on for sixteen (16) minutes, beginning at the top of the hour. All TIs referenced by this SOP reflect this operating mode.

4.1.2 Receiver

The LPV-2 receiver gathers light from the transmitter, converts it to an electrical signal, isolates and measures the received transmitter light, and calculates and outputs visibility results in the desired form. The receiver has three components:

- Long focal-length telescope
- Photodetector eyepiece assembly
- Low power computer

The telescope gathers the transmitter light and focuses it on a photodiode that converts it to an electrical signal. The receiver computer “locks-on” to the transmitter light’s chopped frequency and separates the transmitter light from ambient lighting. The computer compares the measured transmitter light with the known (calibrated) transmitter light to calculate the transmission of the intervening atmosphere.

The effect of atmospheric turbulence is minimized by using 6,250 samples of the signal to calculate a one-minute average reading. The resultant reading is held in the computer and available to a datalogger until the next value is calculated.

Like the transmitter, the receiver is equipped with an eyepiece to precisely aim the detector, and an interval timer to control the interval and duration of measurements.

The receiver can operate in either a continuous or cycled mode. In the continuous mode the receiver measures one-minute averages (using 6,250 samples as described above) on a continuous basis. In the cycled mode the receiver is programmed to begin sampling at precise intervals and stays on for selected durations.

IMPROVE network transmissometers operate in a cycled mode, collecting a 10-minute average of the transmitter irradiance at the start of each hour of the day. The receiver is programmed to begin sampling three minutes after the transmitter lamp turns on. Over the next 10 minutes, the receiver collects and stores 10 one-minute averages. The receiver then uses the 10 one-minute averages to calculate a 10-minute average value for the received lamp irradiance.

4.2 ROUTINE SITE OPERATOR MAINTENANCE

Routine site operator maintenance for the LPV-2 transmissometer includes routine servicing and intermittent servicing. Routine servicing should be performed at 7 to 10 day intervals and includes the following general tasks:

- Checking and resetting telescope alignment
- Cleaning windows, lenses, and solar panels
- Checking system timing
- Verifying power system status
- Documenting “as found” conditions
- Documenting system settings and readings

Intermittent servicing includes preventative maintenance tasks that need to be performed several times throughout the year. Tasks related to system malfunctions and emergency maintenance are considered special servicing as described in Section 4.3, Emergency Maintenance and Troubleshooting.

Intermittent servicing intervals are specific to individual tasks and are usually performed in response to a request by the data coordinator. Intermittent servicing includes:

- Inspecting the physical conditions of the solar panels, deep-cycle batteries, and DCP antenna (monthly).

- Checking the fluid level in deep-cycle batteries and refilling as required (monthly).
- Replacing the transmitter lamp (every two months).

Detailed descriptions of the routine servicing and intermittent servicing tasks and the procedures for accomplishing these tasks are provided in TI 4110-3100, *Routine Site Operator Maintenance Procedures for Optec LPV-2 Transmissometer Systems (IMPROVE Protocol)*.

4.3 EMERGENCY MAINTENANCE AND TROUBLESHOOTING

Site operator maintenance of the LPV-2 transmissometer includes prompt detection of any system malfunction and timely application of emergency maintenance procedures. A system malfunction (obvious or suspected) may be detected by either the site operator during a routine service visit, or the data coordinator's daily data review.

When a malfunction is noted during a site visit, the site operator will either initiate immediate corrective action or contact the data coordinator with a description of the problem. The data coordinator will specify appropriate troubleshooting procedures for the site operator to follow in isolating the malfunction. When the malfunction is identified the data coordinator will initiate the appropriate corrective action.

When the data coordinator's daily data review indicates a possible system malfunction, the data coordinator will notify the site operator of the suspected problem and ask the operator to initiate specific troubleshooting procedures. Corrective action will be initiated by the site operator if the problem is identified during the site visit and can be corrected with on-site parts. If the corrective action requires component replacement or repair, corrective action will be initiated by the data coordinator.

Detailed procedures for troubleshooting and emergency maintenance of the LPV-2 transmissometer are provided in TI 4110-3300, *Troubleshooting and Emergency Maintenance Procedures for Optec LPV-2 Transmissometer Systems (IMPROVE Protocol)*.

In cases requiring repair and/or replacement of a transmissometer system component, the site operator will remove and replace the malfunctioning component and ship the component back to ARS. It is important that the malfunctioning instrument or component be removed and reinstalled without causing damage or disturbing critical adjustments or alignment. Proper preparation for shipping will also prevent instrument damage. TI 4110-3375, *Replacing and Shipping Transmissometer System Components*, describes procedures for performing these tasks.

4.4 ANNUAL SITE VISIT

IMPROVE transmissometers operate in the field for a period of 12 months. An ARS field specialist annually visits each site and removes the "old" transmissometer and replaces it with a fully-serviced instrument and nine calibrated lamps. As a part of this annual site visit, the field specialist performs the following general tasks:

- Documents initial conditions.
- Verifies existing system operation (pre-removal).
- Replaces transmissometer and AT/RH sensor.
- Verifies replacement system operation.
- Cleans and repairs the shelter as required.
- Inspects, checks operation, maintains and/or replaces support equipment and instrumentation.
- Performs a field audit of existing and replacement transmissometers with a reference transmissometer.
- Performs miscellaneous servicing, cleaning, and maintenance.
- Trains site operator(s).

SOP 4115, *Annual Site Visits for Optical Monitoring Instrumentation (IMPROVE Protocol)*, describes the annual site visit. Detailed procedures for the annual site visit are provided in TI 4115-3000, *Annual Site Visit Procedures for Optec LPV-2 Transmissometer Systems (IMPROVE Protocol)*, and SOP 4710, *Transmissometer Field Audit Procedures*.

4.5 ANNUAL LABORATORY MAINTENANCE

The Optec LPV-2 transmissometer is a precision instrument that requires careful cleaning and alignment of all instrument optics to ensure optimum measurement accuracy. This level of servicing must be performed in a laboratory environment using specialized electronic and optical test equipment. Transmissometers operating in the IMPROVE network are replaced in the field and serviced on an annual basis.

When the operational instrument is removed from the field, it is shipped back to ARS for servicing. Each instrument must be fully serviced before it is reinstalled at a field site. Servicing includes the following major tasks:

- Visual inspection
- Post-field calibration
- Pre-servicing alignment check
- Cleaning
- Optics alignment

- Hardware upgrade/modifications
- Component functional tests
- Pre-field calibration

Specific tasks in the laboratory servicing procedure are shown in Figure 4-2, Annual Service Procedure for Optec LPV-2 Transmissometers. Each servicing task and procedure for performing the task is fully described in TI 4110-3400, *Annual Laboratory Maintenance Procedures for Optec LPV-2 Transmissometer Systems (IMPROVE Protocol)*.

Instrument calibration is described in SOP 4200, *Calibration of Optical Monitoring Systems (IMPROVE Protocol)*. Calibration procedures are presented in TI 4200-2100, *Calibration of Optec LPV-2 Transmissometers (IMPROVE Protocol)*; and TI 4200-2110, *Transmissometer Lamp Preparation (Burn-in) Procedures*.

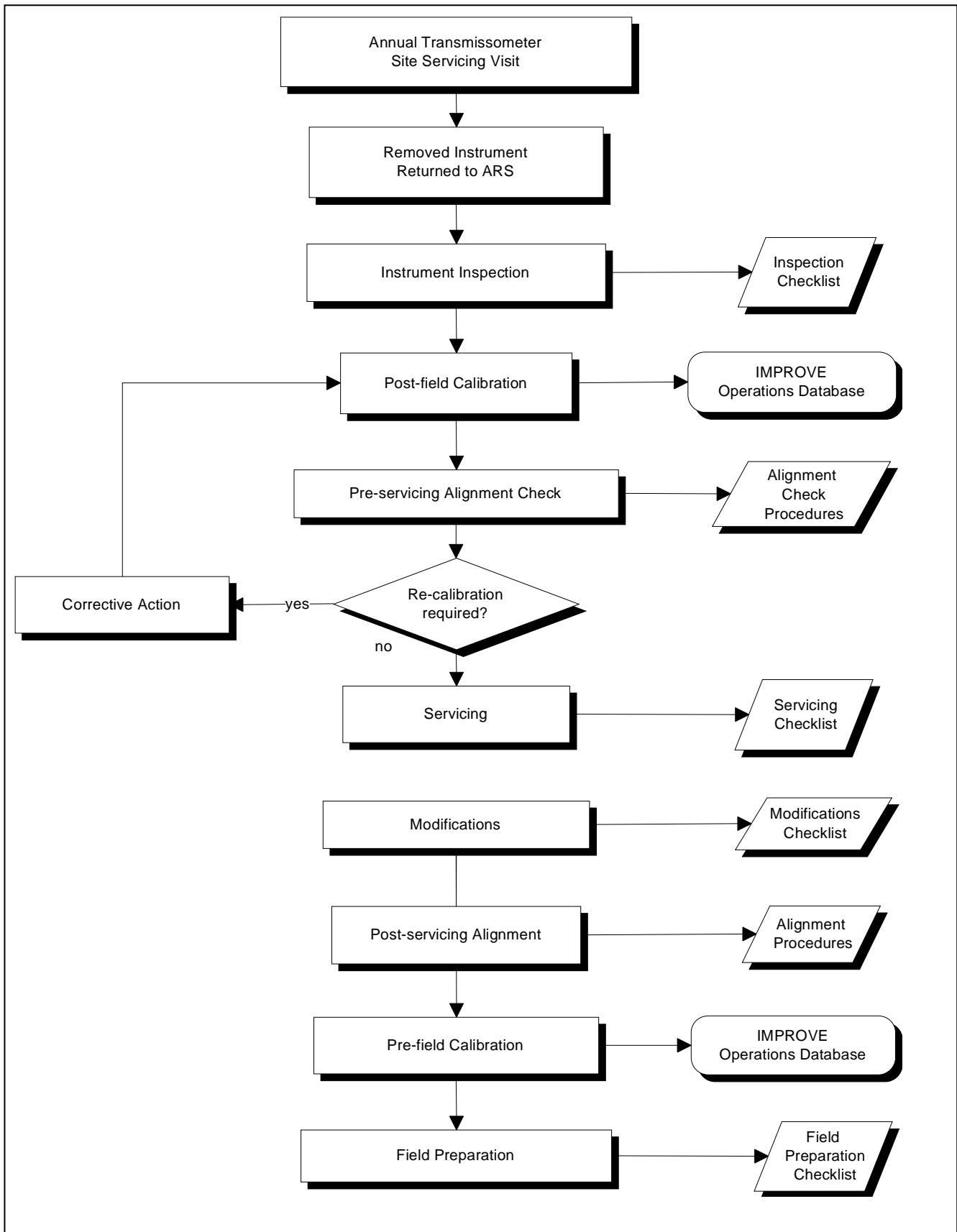

Figure 4-2. Annual Service Procedure for Optec LPV-2 Transmissometers.

QUALITY ASSURANCE/QUALITY CONTROL DOCUMENTATION SERIES	
TITLE	ROUTINE SITE OPERATOR MAINTENANCE PROCEDURES FOR LPV-2 TRANSMISSOMETER SYSTEMS (IMPROVE PROTOCOL)
TYPE	TECHNICAL INSTRUCTION
NUMBER	4110-3100
DATE	MARCH 1993

AUTHORIZATIONS		
TITLE	NAME	SIGNATURE
ORIGINATOR	J. Carter Blandford	
PROJECT MANAGER	Mark Tigges	
PROGRAM MANAGER	David L. Dietrich	
QA MANAGER	Gloria S. Mercer	
OTHER		

REVISION HISTORY			
REVISION NO.	CHANGE DESCRIPTION	DATE	AUTHORIZATIONS
1.0	Various changes including checking voltages	March 1995	
1.1	Minor text and formatting changes	August 1996	
2.0	Delete strip charts / update log sheets	March 2005	

TABLE OF CONTENTS

<u>Section</u>		<u>Page</u>
1.0	PURPOSE AND APPLICABILITY	1
2.0	RESPONSIBILITIES	4
2.1	Project Manager	4
2.2	Field Specialist	4
2.3	Data Analyst	4
2.4	Site Operator	5
3.0	REQUIRED EQUIPMENT AND MATERIALS	5
4.0	METHODS	6
4.1	Routine Servicing	6
4.1.1	Routine Servicing at the Transmitter Station	9
4.1.1.1	Initial Condition	10
4.1.1.2	Servicing	11
4.1.1.3	Timing	13
4.1.1.4	Special Servicing	13
4.1.2	Routine Servicing at the Receiver Station	15
4.1.2.1	Initial Condition	15
4.1.2.2	Servicing	18
4.1.2.3	Timing	19
4.1.2.4	Special Servicing	20
4.2	Intermittent Servicing and Maintenance	21
4.2.1	Checking and Resetting System Timing	21
4.2.2	Transmitter Lamp Changes	23
4.2.3	Solar Power System Servicing	25
4.2.4	AC Power System Servicing	26
4.2.5	Deep-Cycle Battery Servicing	26
4.2.6	Data Collection Platform (DCP) Antenna Servicing	28
4.3	Problems or Questions	28
4.4	Handling Log Sheets	28
APPENDIX A	OPTEC LPV TRANSMISSOMETER OPERATOR'S GUIDE	A-1
APPENDIX B	EXAMPLE COMPLETED LPV-2 TRANSMITTER LOG SHEET	B-1
APPENDIX C	EXAMPLE COMPLETED LPV-2 RECEIVER LOG SHEET	C-1

LIST OF FIGURES

<u>Figure</u>		<u>Page</u>
4-1	LPV-2 Transmissometer Operator Log Sheet – Transmitter Station	7
4-2	LPV-2 Transmissometer Operator Log Sheet – Receiver Station	8
4-3	Transmitter Components Connection Diagram	14
4-4	Extinction (b_{ext}) to Visual Range Conversion Chart	17

LIST OF TABLES

<u>Table</u>		<u>Page</u>
1-1	Transmissometer Servicing Schedule	1
1-2	Transmissometer Transmitter Station, Summary of Servicing Tasks	2
1-3	Transmissometer Receiver Station, Summary of Servicing Tasks	3

1.0 PURPOSE AND APPLICABILITY

This technical instruction (TI) describes the steps of a routine site operator maintenance visit to an Optec LPV-2 transmissometer station (receiver and transmitter) operated according to IMPROVE Protocol. The purpose of routine site operator maintenance is to assure quality data capture and minimize data loss by performing and documenting scheduled operational checks and preventive maintenance on transmissometers, meteorological sensors, data acquisition and control systems, power systems, and support equipment. The transmissometer servicing schedule is provided in Table 1-1.

This TI, as referenced from Standard Operating Procedure (SOP) 4110, *Transmissometer Maintenance (IMPROVE Protocol)*, specifically describes the service and maintenance procedures to be performed at the transmissometer transmitter and receiver stations. Summaries of the servicing procedures are provided in Tables 1-2 and 1-3, for the transmitter and receiver stations, respectively. Tasks are listed in the suggested order of completion. For more detailed instructions, see Section 4.0.

Due to variations in the site configurations of IMPROVE Protocol sites, portions of this TI may not apply to every transmissometer station.

Table 1-1

Transmissometer Servicing Schedule

INTERVAL	SERVICING TASKS
7- to 10-day interval	<p>Complete the servicing tasks listed on the transmissometer log sheets.</p> <p>Both the receiver and transmitter shelters must be visited; the transmitter should be serviced first. Correct operation of the system should be verified at the receiver shortly afterward (same day).</p> <p>The transmitter and receiver system timing should be checked at each site visit.</p>
Monthly interval	<p>The transmitter lamp status LED should be checked.</p> <p>Inspect the physical condition of solar panels, batteries, and DCP antenna. Battery fluid levels should be checked.</p>
2-month interval	<p>Transmitter lamps should be changed. ARS will notify site operators when a lamp change is needed.</p>
Annual interval	<p>Field specialists will make visits once a year to exchange the existing transmissometer system for a newly serviced and calibrated system.</p> <p>Training of site operators in the servicing and maintenance of the monitoring system components will take place during annual field specialist visits.</p>

Table 1-2

Transmissometer Transmitter Station
Summary of Servicing Tasks

ORDER OF COMPLETION	SERVICING TASKS
Before leaving the office	<p>At least once a month, schedule your servicing trip to be at the transmitter station while the transmitter is in the ON mode to check the lamp status LED.</p> <p>When checking the system timing, set your digital watch to the correct time prior to leaving the office by calling the National Institute of Standards and Technology (NIST) recording 1-303/499-7111 (Boulder, CO), or logging onto http://www.time.gov.</p>
At the transmitter station (complete the servicing tasks listed on the log sheet)	<p>Complete the log sheet general information section.</p> <p>Document the initial alignment conditions and/or comment.</p> <p>Record whether the instrument appears to be working properly, and comment.</p> <p>Inspect and document the window cleanliness.</p> <p>Clean the window and comment as necessary. Recheck alignment.</p> <p>Inspect and document telescope lens cleanliness.</p> <p>Clean the solar panels and inspect them for damage.</p> <p>Document the deep-cycle battery voltage.</p> <p>Observe and record the LED status light while the transmitter is on. Document the lamp voltage five minutes into the lamp "on" cycle.</p> <p>Observe and record the transmitter turn "on" and "off" times.</p> <p>Document if the system timing was reset.</p> <p>Record special servicing tasks: lamp change (time of change, lamp number, and lamp voltage).</p> <p>Check supply inventory. Request needed supplies on the log sheet.</p> <p>Record any comments on the log sheet.</p> <p>Leave a copy of the log sheet in the shelter; take the original back to the office.</p> <p>Double-check the alignment and the flip mirror position before leaving the shelter.</p>
Back at the office	<p>Send original log sheets from both the transmitter and receiver to ARS.</p> <p>Call an ARS field specialist or data analyst promptly if a problem or need arises.</p>

Table 1-3

Transmissometer Receiver Station
Summary of Servicing Tasks

ORDER OF COMPLETION	SERVICING TASKS
Before leaving the office	<p>Schedule your servicing trip to be at the receiver station 10 minutes before the hour. Servicing tasks should be performed before the top of the hour. System timing and the updated reading should be observed before leaving.</p> <p>When checking the system timing, set your digital watch to the correct time prior to leaving the office by calling the National Institute of Standards and Technology (NIST) recording 1-303/499-7111 (Boulder, CO), or logging onto http://www.time.gov.</p>
At the receiver station (complete the servicing tasks listed on the log sheet)	<p>Complete the log sheet general information section.</p> <p>Record the receiver computer reading, local time, and toggle state.</p> <p>Record the A1 switch readings for the "B" and "C" positions. Important: Return the A1 switch to the "C" position.</p> <p>Compare the readings to actual visual conditions.</p> <p>Record the receiver computer settings.</p> <p>Document the initial alignment conditions and/or comment.</p> <p>Document if the alignment was corrected.</p> <p>Record whether the instrument appears to be working properly and comment.</p> <p>Inspect and document the window cleanliness. Clean the window and recheck alignment.</p> <p>Inspect and document telescope lens cleanliness.</p> <p>Clean the solar panels and inspect them for damage.</p> <p>Document the deep-cycle battery voltage.</p> <p>Observe and record the transmitter light "on" time.</p> <p>Observe and record the toggle update time.</p> <p>Note the updated receiver reading and record. Also, compare the reading to actual visibility conditions.</p> <p>Observe and record the transmitter light "off" time.</p> <p>Record if the computer timing was reset.</p> <p>Record special servicing tasks: lamp changes and cal # changes.</p> <p>Check supply inventory. Request needed supplies on the log sheet.</p> <p>Record any comments on the log sheet. Leave a copy of the log sheet in the shelter. Take the original back to the office.</p> <p>Double-check the alignment and the flip mirror position before leaving the shelter.</p>
Back at the office	<p>Send original log sheets from both the receiver and transmitter to ARS.</p> <p>Call an ARS field specialist or data analyst promptly if a problem or need arises.</p>

2.0 RESPONSIBILITIES

2.1 PROJECT MANAGER

The project manager shall:

- Coordinate with the site operator, his/her supervisor, field specialist, and data analyst concerning the schedule and requirements for routine maintenance.
- Oversee and review documentation completed by the site operator for accuracy and completeness.

2.2 FIELD SPECIALIST

The field specialist shall:

- Coordinate with the site operator, his/her supervisor, project manager, and data analyst concerning the schedule and requirements for routine maintenance.
- Train the site operator in all phases of the routine maintenance and special servicing procedures necessary for site visits.
- Provide technical support to the site operator via telephone to assure high quality site visits.
- Document all technical support provided to the site operator.
- Resolve problems reported by the site operator.

2.3 DATA ANALYST

The data analyst shall:

- Coordinate with the site operator, his/her supervisor, project manager, and field specialist concerning the schedule and requirements for routine maintenance.
- Review documentation completed by the site operator for accuracy and completeness.
- Verify that scheduled visits are performed and notify the site operator if he/she fails to make a scheduled visit.
- Provide technical support to the site operator via telephone to assure high quality site visits.
- Document all technical support provided to the site operator.

- Review and file all site documentation.
- Resolve problems reported by the site operator.
- Ship cleaning and other necessary supplies for routine maintenance to the site operator.
- Enter all correspondence with site operators and the results of all performed procedures into the site-specific timeline.

2.4 SITE OPERATOR

The site operator shall:

- Coordinate with his/her supervisor, project manager, field specialist, and data analyst concerning the schedule and requirements for routine maintenance.
- Perform all procedures described in this TI.
- Thoroughly document all procedures on the LPV-2 Transmissometer Operator Log Sheet and mail and fax the log sheet to the data analyst.
- Report any noted inconsistencies immediately to the data analyst or field specialist.

3.0 REQUIRED EQUIPMENT AND MATERIALS

The equipment generally required to support a weekly site visit includes:

- Medium and small flat-blade screwdriver
- Medium adjustable wrench
- Keys for shelters and padlocks
- Voltmeter and cables
- Battery tester
- Isopropyl alcohol and Kimwipes
- Glass cleaner and paper towels
- Photographic (blower) brush
- Distilled water

- Battery terminal cleaner
- Wire brush
- Flashlight and/or signal mirror
- Site Operator's Manual for Transmissometer Monitoring Systems
- LPV-2 Transmissometer Operator's Guide
- LPV-2 Transmissometer Operator Log Sheets (transmitter and receiver)
- Pen or pencil
- Notebook for yellow copies of log sheets
- Digital watch

4.0 METHODS

This section includes four (4) major subsections:

- 4.1 Routine Servicing
- 4.2 Intermittent Servicing and Maintenance
- 4.3 Problems or Questions
- 4.4 Handling Log Sheets

The procedures described in these sections refer to specific instrument components. Detailed schematic diagrams and instrument component descriptions are provided for reference in TI 4110-3350, *Transmissometer Monitoring System Diagrams and Component Descriptions*. Resolution of problems noted during routine or intermittent servicing can be more fully investigated by following the troubleshooting procedures defined in TI 4110-3300, *Troubleshooting and Emergency Maintenance Procedures for Optec LPV-2 Transmissometer Systems (IMPROVE Protocol)*.

4.1 ROUTINE SERVICING

This subsection describes transmissometer monitoring system routine servicing tasks and log sheet entries. A log sheet is required for both the transmitter and receiver stations (see Figures 4-1 and 4-2). The transmissometer operator log sheets are divided into four (4) main sections:

- Initial Condition
- Servicing
- Timing
- Special Servicing



**LPV-2 TRANSMISSOMETER OPERATOR LOG SHEET
TRANSMITTER STATION**

Date _____ Local Time _____ Operator(s) _____ Location _____
Weather Conditions _____
Visibility Conditions: Excellent Good Fair Poor Estimated visual range _____ miles
Details _____

INITIAL CONDITION

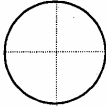
- Instrument Number LPV- _____
- Mark the **INITIAL** location of receiver shelter window with a "+" in the circle below.

Comments _____
IMPORTANT: Return flip mirror to proper (ON) position.
- Was the alignment corrected? Yes No If Yes, time aligned _____
- Does the instrument appear to be working properly? Yes No
If No, provide details _____

SERVICING

- Initial Window Cleanliness: Good Moderate Poor
Comment _____
- Window Cleaned? Yes No If Yes, time cleaned _____
If No, why not? _____
- Lens Inspected? Yes No If Yes, lens cleaned? Yes No
IMPORTANT: Use only the blower brush to clean the telescope lens.
- Solar Panels Cleaned? Yes No Comment _____
- Battery Voltage (charging) _____ Battery Voltage (analyzing) _____
Battery fluid levels should be checked monthly and filled if low.
- Lamp Check **IMPORTANT: Must be done when lamp is ON under automatic control.**
 - LED (indicator light on side of control box) On Off (If On, telephone ARS)
 - Lamp Voltage Reading (switch voltmeter to 20 VDC range) _____ volts, for lamp number _____**IMPORTANT: Switch voltmeter to "OFF" after taking voltage reading.**

TIMING

- Is your watch synchronized with NIST time? (telephone 303-499-7111 or <http://www.time.gov>) Yes No
 - Transmitter Light ON, Exact Time, (HR:MIN:SEC) _____:_____:
 - Transmitter Light OFF, Exact Time, (HR:MIN:SEC) _____:_____:
 - Timing Reset? Yes No If Yes, time transmitter was reset _____
- IMPORTANT: THE TRANSMITTER TIMING MUST ONLY BE RESET AT EXACTLY THE TOP OF THE HOUR!**

SPECIAL SERVICING (upon ARS instruction)

- Lamp Changed? Yes No If Yes, old lamp number _____ Old lamp voltage _____
Time lamp changed _____ New lamp number _____ New lamp voltage _____
IMPORTANT: If lamp is changed, receiver computer calibration (CAL) number must also be changed.
- Alignment corrected after lamp change? Yes No

GENERAL COMMENTS/SUPPLIES NEEDED

Send the white copy of this form to:
(keep the yellow copy on site)

Air Resource Specialists, Inc.
1901 Sharp Point Drive, Suite E
Fort Collins, CO 80525

Telephone: 1-800-344-5423
Fax: 1-970-484-3423

Figure 4-1. LPV-2 Transmissometer Operator Log Sheet - Transmitter Station.



LPV-2 TRANSMISSOMETER OPERATOR LOG SHEET
RECEIVER STATION

Date _____ Local Time _____ Operator(s) _____ Location _____
Weather Conditions _____
Visibility Conditions: Excellent Good Fair Poor Estimated visual range _____ miles
Details _____

INITIAL CONDITION

- Instrument Number LPV- _____
- Receiver Display Reading _____ Local Time _____ Toggle: On Off
- Display readings: A1 switch set to: C (raw reading) _____ B(b_{ext} reading) _____
- Does the b_{ext} reading represent actual conditions? Yes No Comment _____

IMPORTANT: Return A1 switch to "C" position after check.

- Settings: Gain _____ Cal _____ Dist _____ A1 _____ A2 _____ Int _____ Cycle _____
- Mark the **INITIAL** location of transmitter light source with a "+" in the circle below.



Comments _____

IMPORTANT: Return flip mirror to proper (ON) position.

- Was the alignment corrected? Yes No If Yes, time aligned _____
- Does the instrument appear to be working properly? Yes No
If No, provide details _____

SERVICING

- Initial Window Cleanliness: Good Moderate Poor Comment _____
- Window Cleaned? Yes No If Yes, time cleaned _____ If No, why not? _____
- Lens Inspected? Yes No If Yes, lens cleaned? Yes No

IMPORTANT: Use only the blower brush to clean the telescope lens.

- Solar Panels Cleaned? Yes No Comment _____
- Battery Voltage (charging) _____ Battery Voltage (analyzing) _____

Battery fluid levels should be checked monthly and filled if low.

TIMING

- Is your watch synchronized with NIST time? (telephone 303-499-7111 or <http://www.time.gov>) Yes No
- Transmitter Light ON, Exact Time, (HR:MIN:SEC) _____:_____:_____
- Receiver Toggle Update, Exact Time, (HR:MIN:SEC) _____:_____:_____
- Updated Receiver Reading: C(raw reading) _____ B(b_{ext} reading) _____ Toggle: On Off

IMPORTANT: Return A1 switch to "C" position after check.

Does the updated b_{ext} reading represent your estimate of visual range? Yes No
Comment _____

- Transmitter Light OFF, Exact Time, (HR:MIN:SEC) _____:_____:_____
- Computer Timing Reset? Yes No If Yes, time reset _____

IMPORTANT: FOR PROPER RECEIVER COMPUTER TIMING RESET PROCEDURES, CALL ARS.

SPECIAL SERVICING (upon ARS instruction)

- Lamp Changed at Transmitter Station? Yes No
IMPORTANT: If lamp is changed, receiver computer calibration (CAL) number must also be changed.
- Receiver computer CAL number changed? Yes No If Yes, new CAL number entered: _____

GENERAL COMMENTS/SUPPLIES NEEDED _____

Send the white copy of this form to:
(keep the yellow copy on site)

Air Resource Specialists, Inc.
1901 Sharp Point Drive, Suite E
Fort Collins, CO 80525

Telephone: 1-800-344-5423
Fax: 1-970-484-3423

Figure 4-2. LPV-2 Transmissometer Operator Log Sheet - Receiver Station.

The initial condition, servicing, and timing sections are a part of routine servicing and should be completed during every site visit. Special servicing includes tasks that are normally performed in response to a request by the data analyst. Procedures related to special servicing tasks are presented in Section 4.2, Intermittent Servicing and Maintenance.

An operator's guide to transmissometer servicing has been prepared as a field reference for routine servicing; a copy of the guide is provided in Appendix A. Operator log sheets are shown as Figures 4-1 and 4-2, and examples of completed log sheets are included in Appendices B (Transmitter), and C (Receiver).

The transmissometer circuitry, especially the internal auto-timers, can be adversely affected by strong radio signals. Do not transmit on a hand-held radio within 10 feet of the transmitter and avoid aiming the antenna at or over the circuitry. Strong radio signals may reset the internal auto-timer, resulting in incorrect system timing.

Before leaving the office, set your digital watch to the correct time by calling the National Institute of Standards and Technology (NIST) recording 1-303/499-7111 (Boulder, CO), or logging onto <http://www.time.gov>.

4.1.1 Routine Servicing at the Transmitter Station

The following general information appears at the top of the transmitter log sheet.

LOCATION	Enter either the full location name or the four-letter site abbreviation.
DATE	Use the standard calendar date, not the Julian date.
LOCAL TIME	Current local time in 24-hour format should be used. Use Daylight Saving Time when applicable. The operator's watch should be set to the correct time prior to leaving the office by calling NIST (see above).
OPERATOR(S)	Use your full name, or your first initial and last name.
WEATHER CONDITIONS	Describe current or recent weather conditions that may be helpful in interpreting the transmissometer readings. Such conditions may include, but are not limited to: <ul style="list-style-type: none">• Passing storm fronts• Impending precipitation• Precipitation events• Stagnant air masses• High winds• Fog

VISIBILITY CONDITIONS Record whether the visibility conditions are excellent, good, fair, or poor, and estimate the visual range.

Describe current or recent visibility conditions that may be useful in verifying correct transmissometer operation. A partial list of such conditions includes:

- Extremely clean
- Plumes visible
- Control burns
- Widespread, uniform haze
- Haze layers

4.1.1.1 Initial Condition

INSTRUMENT NUMBER Record the LPV instrument number. The number can be found on stickers affixed to both the control box and the telescope.

DOCUMENT INITIAL ALIGNMENT To check the alignment, turn the flip mirror knob fully clockwise against the stop to the OFF position. Document the position of the receiver shelter window with respect to the circle on the log sheet with a "+". The receiver should be at the intersection of the "+".

Avoid making alignment checks or adjustments while the transmitter is on. If the flip mirror knob is moved from the ON position to the OFF position while the receiver is making a reading, the extinction reading for that hour will not be valid. If a reading has been affected by an alignment check, note this in the log sheet comment section.

If an initial alignment check is impossible due to weather, haze, turbulence, or lighting conditions, return the flip mirror to the ON position – Do not attempt to align. Record pertinent comments regarding alignment problems to the right of the circle on the log sheet.

CORRECTING ALIGNMENT If the alignment has drifted so that the receiver is not in the center of the reticle circle, adjust the alti-azimuth base controls to center the receiver. Make sure the flip mirror knob is fully against the stop while aligning. Do this only after the initial alignment has been documented.

The circle depicted on the log sheet represents the small, inner reticle circle. The inner reticle circle must remain aligned on the receiver telescope for correct instrument operation.

CORRECTING
ALIGNMENT (continued)

One of your eyes will be dominant; if you have difficulty viewing the scene, try it using your other eye. Some operators find it easier to view the scene from behind the telescope while others prefer to view from the side. Schedule site visits for times of the day with the best viewing conditions. All shelters are equipped with signal mirrors and flashlights for occasions when alignment checks are made with operators at both stations. Finally, keep the eyepiece clean for better viewing.

If the alignment was corrected after the initial alignment documentation, mark **YES** and document the time it was corrected in the space provided. If the alignment was not corrected, mark **NO**.

OPERATIONAL
CONDITION

A general overview of the shelter, instrument, and support equipment should be made to ensure that the system appears to have operated properly since the last servicing visit. Thoroughly document any noted inconsistencies.

4.1.1.2 Servicing

INITIAL WINDOW
CLEANLINESS

Remove the windowpane from its frame and visually inspect it for water drop deposits, film, unusually heavy dust, and insects or pests that may reduce the transmission of light through the glass. Make comments when applicable. It is most important to inspect the portion of the glass pane that is directly in front of the transmitter lens.

CLEAN WINDOW

The shelter window should be cleaned during every site visit. If for some reason the window is not cleaned, document its condition in the comments section. Document the time that the window was cleaned in the space provided. To clean the window:

- Remove the windowpane from the frame.
- Inspect the hood and frame for spider webs.
- Use only Kimwipes and alcohol to clean both sides of the glass. Use plenty of cleaning fluid, change Kimwipes often, and use a light hand.
- Reinstall the windowpane after inspecting for smears, smudges, etc.

CLEAN WINDOW
(continued)

- Recheck the alignment.
- Do not use canned air to clean the windows or objective lens.

The objective in cleaning optical surfaces is to remove the abrasive dust particles and film without damaging the glass surface. Always remove the large particles first and progress toward the removal of films. Use a light touch, plenty of cleaning fluid, and frequent changes of cleaning paper. Clean with a circular, rubbing motion.

INSPECT LENS

Remove the shelter window and look closely at the transmitter telescope lens from a number of angles. Note any accumulation of dust, dirt, smudges, or other foreign material on the lens. If any accumulation is noted, use the blower brush to clean the objective lens. Use a light touch. If an accumulation on the lens cannot be removed with the blower brush, call ARS for further instructions. Also, use the blower brush to remove dust from the body of the transmitter telescope. Clean the eyepiece with alcohol and Kimwipes. Use only the blower brush to clean the objective lens.

CLEAN SOLAR PANELS

Use glass cleaner and paper towels to clean dust and dirt from the solar panels. In the winter, sweep snow off the panels, but avoid scraping ice as damage to the panels could occur.

CHECK BATTERY
VOLTAGE

At solar powered sites, it is important to verify that the solar charging system is operating properly. Use the on-site voltmeter to measure the voltage on the deep-cycle batteries when the charge regulator is “charging” and when “analyzing”. Disconnect the voltmeter cable from the lamp voltage measurement pigtail and reconnect the voltmeter cable to the battery measurement pigtail (refer to Figure 4-3). Set the voltmeter switch to the 20 VDC setting. Document the charging and analyzing voltage readings on the log sheet. Set the voltmeter switch to off and reconnect the voltmeter cable to the lamp voltage measurement pigtail. Operation of the charge regulator is described in Section 4.2.4.

The battery fluid level should be checked monthly. If the fluid level is below the top of the plates, refill it with distilled water. If fluid is added, this should be noted in the comments/supplies section of the log sheet. Detailed descriptions for the deep-cycle batteries servicing procedures are provided in Section 4.2.6.

LAMP CHECK

Record the status (on or off) of the lamp check LED located on the side of the control box. The LED status may be difficult to determine in direct sunlight. Shading the LED with your hand will make it easier to determine whether the LED is on or off. If the lamp voltage LED is on while the transmitter light is on, the lamp needs replacing. Procedures for changing lamps are described in Section 4.2.2. Before replacing the lamp, measure and document the lamp voltage as described below. This check is valid only when the instrument is in its On mode; if the instrument is turned on with the test switch, the LED will always turn on.

A calibrated voltmeter has been supplied for measuring the operational lamp voltage of the transmitter. The voltmeter should be connected to the lamp voltage measurement pigtail, as indicated in Figure 4-3. After the lamp has been on for at least five minutes, check the voltage by switching the voltmeter to the 20 VDC range. Turn the voltmeter off after documenting voltage and lamp number on the log sheet.

4.1.1.3 Timing

CHECK TIMING

Document whether or not your watch is synchronized with NIST time by marking **YES** or **NO**. Observe and document the exact time the transmitter light comes on and goes off in the spaces provided.

RESET TIMING

Procedures for checking and resetting the transmitter internal auto-timer are described in Section 4.2.1. Document the results of a timing check before resetting the time. If the time is reset, document it on the log sheet. Timing checks should be made during each site visit.

4.1.1.4 Special Servicing

CHANGE LAMP

Procedures for changing lamps are described in Section 4.2.2. If a lamp change is made, document the time the lamp was changed, and the old and new lamp numbers and voltages. The lamp number is located on a sticker attached to the back of the lamp.

RECHECK ALIGNMENT

Changing the lamp can result in telescope movement and misalignment. Always recheck alignment after a lamp change and make sure to return the flip mirror to the correct position before leaving the site.

GENERAL COMMENTS / SUPPLIES NEEDED

Space for additional comments is provided at the bottom of the log sheet. This space should also be used to request additional servicing supplies.

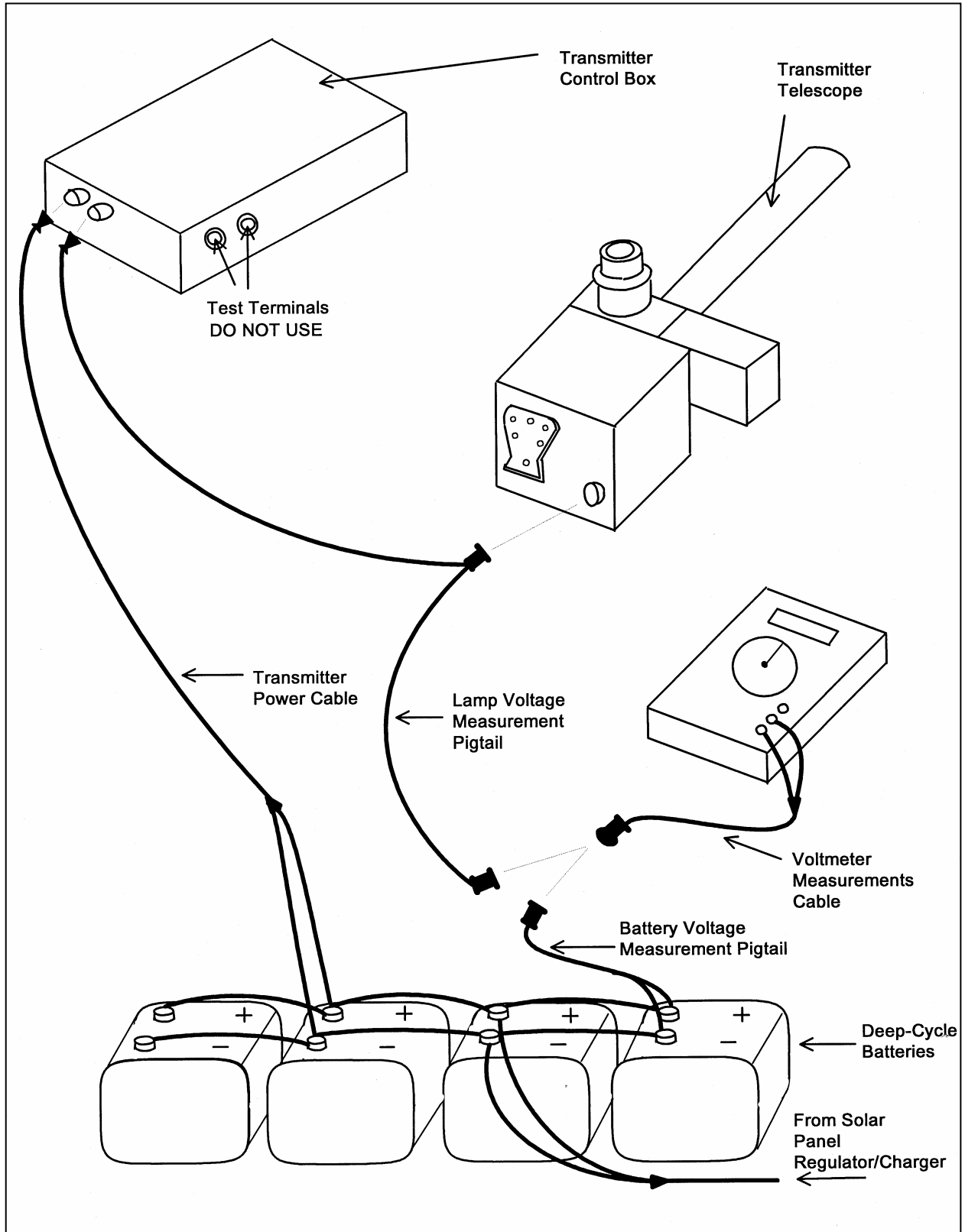

Figure 4-3. Transmitter Components Connection Diagram.

4.1.2 Routine Servicing at the Receiver Station

The following general information appears at the top of both the transmitter and receiver log sheets.

LOCATION Enter either the full location name or the four-letter site abbreviation.

DATE Use the standard calendar date, not the Julian date.

LOCAL TIME Current local time in 24-hour format should be used. Use Daylight Saving Time when applicable. The operator's watch should be set to the correct time prior to leaving the office by calling NIST (see above).

OPERATOR(S) Use your full name, or your first initial and last name.

WEATHER CONDITIONS Describe current or recent weather conditions that may be helpful in interpreting the transmissometer readings. Such conditions may include, but are not limited to:

- Passing storm fronts
- Impending precipitation
- Precipitation events
- Stagnant air masses
- High winds
- Fog

VISIBILITY CONDITIONS Record whether the visibility conditions are excellent, good, fair, or poor, and estimate the visual range.

Describe current or recent visibility conditions that may be useful in verifying correct transmissometer operation. A partial list of such conditions includes:

- Extremely clean
- Plumes visible
- Control burns
- Widespread, uniform haze
- Haze layers

4.1.2.1 Initial Condition

INSTRUMENT NUMBER Record the LPV instrument number. The number can be found on stickers affixed to the receiver computer and telescope.

RECEIVER DISPLAY	Record the receiver display reading (A1 switch in C position) shown on the receiver computer display upon entering the shelter. Also record the local time and toggle state.
DISPLAY READINGS	Record the reading of the A1 switch in the “C” (raw reading) and “B” (b_{ext} reading) positions. Return the switch to the “C” position.
ACTUAL CONDITIONS	Use the orange conversion chart (Figure 4-4) to convert b_{ext} to visual range. Compare this value with the actual visibility conditions. If the reading does not correspond with the actual conditions, note the inconsistency in the comments section and call ARS.
COMPUTER SETTINGS	Record the position or numerical setting of each of the receiver computer front panel switches (Gain, Cal, Dist., A1, A2, Int, and Cycle).
DOCUMENT INITIAL ALIGNMENT	<p>To check the alignment, turn the flip mirror knob fully clockwise against the stop to the OFF position. Document the position of the transmitter with respect to the circle on the log sheet with a “+”. The light source would be at the intersection of the “+”.</p> <p>If the transmitter shelter is easily visible, do not interrupt a reading to make an alignment check. When viewing conditions are marginal, use the transmitter light source as an aid in alignment. The receiver can be placed in the OFF position for a short time immediately after the transmitter turns on, or following a toggle and reading update, without affecting a measurement. Document any interruption of a reading on the log sheet.</p> <p>In an alignment check is impossible due to weather, haze, turbulence, or lighting conditions, return the flip mirror to the ON position – <u>Do not</u> attempt to align. Record pertinent comments regarding alignment problems to the right of the circle on the log sheet.</p>
CORRECTING ALIGNMENT	If the alignment has drifted so that the transmitter is not in the center of the reticle circle, adjust the alti-azimuth base controls to center the transmitter. Make sure the flip mirror knob is fully against the stop while aligning. Do this only after the initial alignment has been documented.

DOES THE CURRENT TRANSMISSOMETER READING MAKE SENSE?

CONVERT THE COMPUTER-DISPLAYED READING TO VISUAL RANGE USING THE CHART BELOW.
DOES THIS VALUE AGREE WITH THE CURRENT VISIBILITY CONDITIONS?

IF NOT, CHECK

- FLIP MIRROR
- ALIGNMENT
- TIMING

IF THE PROBLEM CANNOT BE RESOLVED, CALL ARS AT 970-484-7941

COMPUTER DISPLAY B_{ext} (KM ⁻¹)	VISUAL RANGE (KILOMETERS)	VISUAL RANGE (MILES)
.010	391	243
.015	261	162
.020	196	122
.025	156	97
.030	130	81
.035	112	69
.040	98	61
.045	87	54
.050	78	49
.060	65	41
.070	56	35
.080	49	30
.090	43	27
.100	39	24
.200	20	12
.300	13	8
.400	10	6
.500	8	5
.600	7	4
.700	6	3
.800	5	3
.900	4	3
1.000	<4	<3

Figure 4-4. Extinction (b_{ext}) to Visual Range Conversion Chart.

CORRECTING
ALIGNMENT (continued)

The circle depicted on the log sheet represents the reticle circle. The reticle circle must remain aligned on the transmitter for correct instrument operation.

If the alignment was corrected after the initial alignment documentation, mark **YES** and document the time it was corrected in the space provided. If the alignment was not corrected, mark **NO**.

OPERATIONAL
CONDITION

A general overview of the shelter, instrument, and support equipment should be made to ensure that the system appears to have operated properly since the last servicing visit. Thoroughly document any noted inconsistencies.

4.1.2.2 Servicing

INITIAL WINDOW
CLEANLINESS

Visually inspect the shelter window for water drop deposits, film, unusually heavy dust, and insects or pests that may reduce the transmission of light through the glass. Make comments when applicable. It is most important to inspect the glass directly in front of the receiver lens.

CLEAN WINDOW

The shelter window should be cleaned during every site visit. If for some reason the window is not cleaned, document its condition in the comments section. Document the time that the window was cleaned in the space provided. To clean the window:

- Remove the windowpane from the frame.
- Inspect the hood and frame for spider webs.
- Use only Kimwipes and alcohol to clean both sides of the glass. Use plenty of cleaning fluid, change Kimwipes often, and use a light hand.
- Reinstall the windowpane after inspecting for smears, smudges, etc.
- Recheck alignment.
- Do not use canned air to clean the windows or objective lens.

The objective in cleaning optical surfaces is to remove the abrasive dust particles and film without damaging the glass surface. Always remove the large particles first and progress toward the removal of films. Use a light touch, plenty of cleaning fluid, and frequent changes of cleaning paper. Clean with a circular, rubbing motion.

INSPECT LENS

Remove the shelter window and look closely at the receiver telescope objective lens from a number of angles. Note any accumulation of dust, dirt, smudges, or other foreign material on the lens. If any accumulation is noted, use the blower brush to clean the objective lens. Use a light touch. If an accumulation on the lens cannot be removed with the blower brush, call ARS for further instructions. Also, use the blower brush to remove dust from the body of the transmitter telescope. Clean the eyepiece with alcohol and Kimwipes. Use only the blower brush to clean the objective lens.

CLEAN SOLAR PANELS

Use glass cleaner and paper towels to clean dust and dirt from the solar panels. In the winter, sweep snow off the panels, but avoid scraping ice as damage to the panels could occur.

BATTERY VOLTAGE

At solar powered sites, it is important to verify that the solar charging system is operating properly. Use the on-site voltmeter to measure the voltage on the deep-cycle batteries when the charge regulator is “charging” and when “analyzing”. Disconnect the voltmeter cable from the lamp voltage measurement pigtail and reconnect the voltmeter cable to the battery measurement pigtail (refer to Figure 4-3). Set the voltmeter switch to the 20 VDC setting. Document the charging and analyzing voltage readings on the log sheet. Set the voltmeter switch to off and reconnect the voltmeter cable to the lamp voltage measurement pigtail. Operation of the charge regulator is described in Section 4.2.4.

The battery fluid level should be checked monthly. If the fluid level is below the top of the plates, refill it with distilled water. If fluid is added, this should be noted in the comments/supplies section of the log sheet. Detailed descriptions for the deep-cycle batteries servicing procedures are provided in Section 4.2.6.

4.1.2.3 Timing

CHECK TIMING

Document whether or not your watch is synchronized with NIST time by marking **YES** or **NO**. Observe and document the exact time the transmitter light comes on and goes off in the spaces provided.

Record the exact time the transmitter light turns on and off, and the exact time the receiver toggle light changes state in the appropriate spaces.

The transmissometer system operates according to the timed sequence described below. It is possible to check the system timing of both the receiver and the transmitter from the receiver station.

CHECK TIMING (continued)	<u>HR:MI:SEC</u>	<u>ACTION</u>
	09:00:00	Transmitter turns ON
	09:03:00	Receiver begins 10-minute average reading (cannot be observed)
	09:13:20	Receiver finishes reading, toggle changes, front panel display updates
	09:16:00	Transmitter turns OFF
	10:00:00	Transmitter turns ON

The sequence repeats hourly.

The system clocks will drift over time. For correct operation, it is critical that the receiver take its reading well-centered within the lamp-on interval.

RECEIVER READING Record the updated receiver reading of the “C” and “B” positions of the A1 switch. Document whether the toggle is on or off.

ACTUAL CONDITIONS Document whether the b_{ext} reading represents your estimate of visual range.

RESET COMPUTER Document whether or not a computer reset was performed during this site visit.

The computer is reset by turning the power switch **OFF** for at least ten seconds and returning it **ON** (see Section 4.2.1). If the computer is reset, the timing must also be reset.

RESET TIME Document whether or not a timing reset was performed during this site visit. A timing reset must be done each time the computer is reset.

4.1.2.4 Special Servicing

CHANGE LAMP Document whether or not the lamp was changed at the transmitter station. If the lamp was changed at the transmitter, the receiver computer calibration number (cal #) must also be changed.

CHANGE CALIBRATION NUMBER Document whether or not the calibration number (cal #) was changed and record the new number.

GENERAL COMMENTS / SUPPLIES NEEDED Space for additional comments is provided at the bottom of the log sheet. This space should also be used to request additional servicing supplies.

4.2 INTERMITTENT SERVICING AND MAINTENANCE

This section presents detailed procedures to accomplish the following intermittent servicing and maintenance tasks:

- Checking and resetting system timing
- Transmitter lamp changes
- Solar power system servicing
- AC power system servicing
- Deep-cycle battery servicing
- Data collection platform (DCP) antenna servicing

The procedures described in the following subsections refer to specific instrument components. Detailed schematic diagrams and instrument component descriptions are provided for reference in TI 4110-3350, *Transmissometer Monitoring System Diagrams and Component Descriptions*.

4.2.1 Checking and Resetting System Timing

When resetting the timing at both stations, reset the transmitter timing first.

CHECK TRANSMITTER TIMING Set your digital watch by calling the National Institute of Standards and Technology in Boulder, Colorado (1-303/499-4111), or logging onto <http://www.time.gov>.

The transmitter beam can be observed at the receiver station with the unaided eye or through the telescope. At the transmitter, the light can be seen at the back of the instrument through the lamp housing. Do not look into the transmitter telescope.

Observe the time the transmitter light turns either on or off. Document this on the appropriate log sheet.

CHECK RECEIVER TIMING Observe the receiver computer toggle light and record the time it changes state (i.e., on to off, or off to on).

TIMING SEQUENCE The transmissometer system should follow the following timing sequence:

TIMING SEQUENCE
(continued)

<u>HR:MI:SEC</u>	<u>ACTION</u>
XX:00:00	Transmitter lamp turns ON
XX:03:00	Receiver begins 10-minute average reading (cannot be observed)
XX:13:20	Receiver finishes reading, toggle changes, front panel display updates
XX:16:00	Transmitter turns OFF
XX:00:00	Sequence repeats hourly

TIMING TOLERANCE

IMPORTANT: When there is less than 45 seconds or more than 5 minutes between the toggle update and the lamp turnoff, the timing system needs resetting.

RESET TRANSMITTER
TIMING

To reset transmitter timing:

- Set your digital watch to NIST time (see above) before going to the station.
- Arrive at the transmitter station at least five minutes before the hour.
- Leave the ON/OFF switch in the ON position (up) and the test switch in the OFF position (down). Test switches are on units with serial numbers 004 or higher.
- Remove the control box cover (four screws).
- Precisely at the top of the hour (any hour), push the time reset button all the way down, hold for ½ second, and release (see TI 4110-3350, *Transmissometer System Diagrams and Component Descriptions*).
- Upon release of the time reset switch, the transmitter lamp will turn on.
- Replace the control box cover.
- Verify that the transmitter (lamp) turns off at 16 minutes past the hour.
- Document the time reset on the transmitter log sheet.

To set receiver timing:

- Set your digital watch to NIST time (see above) before going to the station.

RESET TRANSMITTER
TIMING (continued)

- Arrive at the receiver station at least five minutes before the hour.
- Turn the computer power switch off at the top of the hour (or before) and leave the switch in the OFF position for at least 10 seconds, then flip the switch back on. For switch locations, see TI 4110-3350, *Transmissometer System Diagrams and Component Descriptions*. It is important to have the receiver computer reset (OFF and back ON) for at least a couple minutes or more before resetting and retiming.
- At precisely 3 minutes after the hour (or 3 minutes after the transmitter light turns on), hold the time reset switch in the UP position for ½ second. Let it return to its down or ON position.
- Verify that the reading updates and the toggle light changes state at approximately 13 minutes and 20 seconds after the hour.
- Document the time reset on the receiver log sheet.

4.2.2 Transmitter Lamp Changes

LAMP REMOVAL

IMPORTANT: Lamps are removed by pulling them out; do not loosen the screws on the lamp housing plate. Since the lamp filaments are fragile, especially after use, the lamps should be removed and inserted very carefully and gently.

Refer to TI 4110-3350, *Transmissometer System Diagrams and Component Descriptions*, for the location of the items described.

To remove transmitter lamps:

- Arrive at the transmitter station 10-15 minutes before the top of the hour to allow time for removing the old lamp and for cleaning the new lamp before insertion.
- If the transmitter is in the ON mode and a reading is being taken, do not disrupt the reading – wait until the transmitter has turned off.
- Do not attempt to change lamps if there is less than five minutes before the start of the hour.
- Take the new lamp out of the lamp case, handling it by the holder only. Do not touch the glass with your fingers.

LAMP REMOVAL
(continued)

- Clean the lamp with alcohol and Kimwipes. Carefully set the lamp aside in a safe place.
- Remove the old lamp by pulling out on the lamp holder. Some lamps may have to be removed by gently prying around the lamp holder with the aid of a small flat-blade screwdriver. Do not loosen any screws on the lamp housing plate.
- Place the old lamp in the lamp case. Mark the date and time the lamp was removed on the transmitter operator log sheet.

LAMP INSERTION

To insert a new lamp:

- Insert the cleaned replacement lamp into the lamp socket. Be very careful to align the lamp contact pins with the holder sockets, then firmly push the lamp all the way in. The lamp must be fully seated into the socket for proper instrument operation.
- **IMPORTANT:** the lamp will not turn on unless proper contact is made.
- Verify that the lamp comes on under auto-control at the top of the hour.
- Take a lamp voltage reading and document on the operator log sheet (see Section 4.1.2, Lamp Voltage).
- Document the lamp change on the operator log sheet.

CALIBRATION SETTING

Each lamp outputs a slightly different amount of light, requiring a new calibration number setting on the receiver computer with each lamp replacement. Each lamp has been pre-calibrated to determine the lamp-specific calibration number. ARS will call the site operator to request a lam change and will provide the correct calibration number for each new lamp. Set the calibration number on the receiver computer using the thumb-wheel switches labeled "CAL".

POST-CALIBRATIONS

Lamps removed from service will be post-calibrated at ARS after annual site visits. Extra care should be taken in handling and transporting these used lamps because the filaments become very brittle and fragile with use.

4.2.3 Solar Power System Servicing

SOLAR PANELS AND WIRING

To check the solar panels:

- Clean solar panels with the supplied glass cleaner and paper towels.
- Inspect the glass for cracks and scratches.
- Check mounting nuts and bolts for tightness.
- Visually inspect wiring for signs of damage due to rodents or chafing.
- If the panels are on a free-standing mount, check that the alignment perpendicular to true south has not been altered.
- Document results of these checks on the operator log sheets. Contact ARS if signs of damage are observed.
- Check M-8/M-16 solar panel regulator LED status indicators for proper operation (see below).

M-8/M-16 SOLAR PANEL REGULATOR

The M-8 and M-16 units include four LED status indicators. They are described below:

- PV READY will light when the solar panel voltage is high enough to charge the battery.
- ANALYZING will light when the controller has temporarily stopped the charging current to the battery to allow proper battery chemical mixing to prevent battery damage. In 30 to 60 seconds (sooner if the voltage is lower and charging more often is necessary) the charging light will re-engage.
- CHARGING will light to indicate that the controller is allowing full charging current to flow to the battery.
- FINISHING will start to slowly flash as the battery reaches full charge. As the battery voltage rises, the flash rate will increase. This variable flash rate will indicate the rate of battery voltage wing and indirectly indicate the battery's state of charge.

4.2.4 AC Power System Servicing

SURGE PROTECTORS Visually check the status of the surge protector indicator lights. Two versions of Northern Technologies' surge protectors protect instruments from potentially-damaging power surges. One model has two system warning lights, the other has three lights. The lights indicate the surge operating condition of the protector as described below:

Green Light: The surge protector is in good operating condition.

Yellow Light: The surge protector has sustained partial damage as the result of a power surge, but is still capable of providing protection.

Red Light: The surge protector has sustained a massive power surge and is no longer capable of providing protection.

If the red light on either model surge protector is lit, call ARS for a replacement unit.

POWER SUPPLY A 10-amp power supply is used at the transmitter when AC power is available. A 5-amp power supply is used at the receiver when AC power is available. Check to see if the power supply indicator light is on when the power supply is turned on.

WIRING AND CONNECTORS Periodically check wiring for damage and connectors for tightness.

4.2.5 Deep-Cycle Battery Servicing

BATTERY FLUID LEVEL Battery fluid level should be checked monthly. The fluid level is visible through the plastic case of the battery and should be between the two indicator marks on the battery case. Batteries in the small version transmitter shelters may be difficult to check. In that case, a check of one battery would suffice.

If the battery fluid level is low, use only distilled water to bring the level up. Low battery fluid levels indicate a possible problem with the solar panel regulators. Call ARS if the batteries require fluid and check the batteries every site visit until directed otherwise.

Under normal operating conditions, battery fluid should only need to be added during annual field specialist site visits.

BATTERY CONTACTS

Visually inspect battery contacts for signs of excess corrosion or deposits. Wire brushes have been supplied to remove the deposits if needed. Under most conditions, terminals will only need cleaning once a year by field specialists. If terminals need cleaning, follow the directions listed below.

CLEANING BATTERY CONTACTS

- Notify ARS of the need to clean the terminals. Do not attempt this if you are unsure.
- Turn off power to the following instruments (do not disrupt a transmissometer reading).

At Receiver Station

- Receiver computer
- Also, disconnect solar panel regulator connection to station (do not let “+” and “-” connections touch each other).

At Transmitter Station

- Transmitter control box
 - Disconnect solar panel regulator connection to battery (do not let “+” and “-” connections touch each other.
 - Make sure the wiring is labeled and is easily identifiable as to positive (+) and negative (-) leads.
 - Draw a diagram depicting power lead attachments. (Positive interconnects to positive terminals, negative interconnects to negative terminals).
 - Remove and clean one contact surface at a time starting with all negative leads (-).
- **CAUTION:** sparks will occur if battery leads touch metal objects or each other.
 - Clean contacts with the supplied wire brush.
 - Compare the battery system wiring with your diagram after you have finished and the wires are reconnected. (Positive interconnects to positive terminals, negative interconnects to negative terminals).
 - Turn all instrumentation back ON and verify correct operation of each component. System timing may need to be reset when power is turned back ON (see Section 4.5).
 - Document this servicing on the operator log sheets.
 - Call ARS and advise them that the servicing has been completed.

VOLTAGE READING Take a deep-cycle battery voltage reading at least once a month. Turn the voltmeter to the 20 VDC setting and connect the positive lead to the “+” terminal and the negative lead to the “-” terminal of the battery. Document the voltage reading on the log sheet and turn the voltmeter off.

4.2.6 Data Collection Platform (DCP) Antenna Servicing

ANTENNA INSPECTION The DCP antenna should be visually inspected periodically. First, check that the mounting base is securely affixed to the shelter. Secondly, the driver, reflector, and directional elements should be securely attached and in position. Lastly and most important, the antenna alignment should be correct (southwesterly orientation with inclination angle of about 45°).

CABLE AND CONNECTOR INSPECTION Inspect the antenna cable for rodent damage or chafing. The cable connector at the base of the antenna should be checked periodically for tightness.

4.3 PROBLEMS OR QUESTIONS

Call ARS immediately if any problems occur or if any questions arise. Many problems can be resolved through telephone consultation.

ARS may be reached at the following telephone numbers:

Telephone: 970/484-7941
Fax: 970/484-3423

Detailed troubleshooting procedures to assist with telephone-directed problem resolution are presented in TI 4110-3300, *Troubleshooting and Emergency Maintenance Procedures for Optec LPV-2 Transmissometer Systems (IMPROVE Protocol)*.

4.4 HANDLING LOG SHEETS

The site operator must complete a transmissometer operator log sheet for each transmitter and receiver site visit. Upon returning to the office, fax the completed sheets to ARS (Fax 970/484-3423) or mail the original log sheets to ARS:

Air Resource Specialists, Inc.
Attn: Optical Data Analyst
1901 Sharp Point Drive, Suite E
Fort Collins, CO 80525

Any additional information or other pertinent supplemental documentation that the operator deems important can also be included with the log sheets.

APPENDIX A

NPS Visibility Monitoring Network Optec LPV-2 Transmissometer Operator's Guide



OPTEC LPV TRANSMISSOMETER OPERATOR'S GUIDE

OVERVIEW

The Optec LPV transmissometer system is available in two models, the LPV-2 and the LPV-3. The instrument continuously and directly measures the light transmission properties of the atmosphere along a selected sight path.

The instrument has two primary components: a light source (transmitter) and a light detector (receiver). Depending on the expected range of visual air quality, the components are generally placed from 0.5 to 10 kilometers apart.

The transmitter emits a uniform, chopped, incandescent light beam of constant intensity at regular intervals, and can operate in either a continuous or cycled mode. In the continuous mode, the transmitter projects the chopped signal continuously. In

the cycled mode, the transmitter is programmed on at precise intervals and stays on for selected durations.

The receiver computer locks onto the transmitter light's chopped frequency and separates the transmitter light from ambient lighting. The computer compares the measured transmitter light with the known (calibrated) transmitter light to calculate the transmission of the intervening atmosphere.

The LPV-2 and LPV-3 models differ with the transmitter; the receiver unit is the same. The LPV-2 transmitter includes a control box that controls the lamp functions, while the LPV-3 controls are internal, and accessed via a digital display on the telescope.

Air Resource Specialists, Inc.
1901 Sharp Point Drive, Suite E
Fort Collins, CO 80525
(970) 484-7941

TRANSMITTER

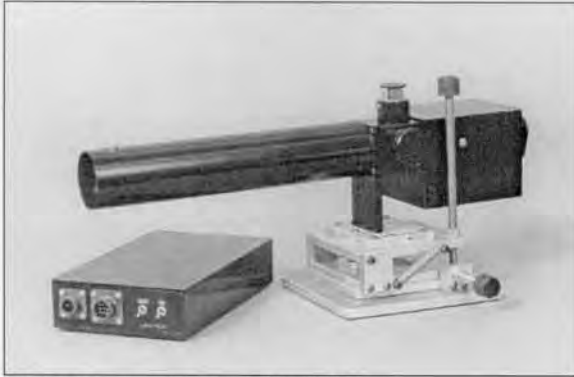

LPV-2 transmitter telescope and control box
(the LPV-3 model does not have a control box)

Introduction

For correct operation, the transmitter must have the proper:

- Alignment
- Timing
- Viewing mirror position
- Window and optical cleanliness
- Lamp regulation
- Power supply

Servicing Frequency

Both the transmitter and receiver stations should be visited weekly. The transmitter should be visited first. Correct operation of the entire system should be verified shortly thereafter at the receiver. Schedule your servicing visit to arrive at the transmitter shelter 10 minutes before the hour. Log sheets must be completed during each site visit.

Regular Maintenance

The primary transmitter servicing tasks are listed below. For detailed descriptions of these tasks and log sheet entries, consult the *Site Operator's Manual for Transmissometer Monitoring Systems*.

1. **Initial Inspection.** Prior to servicing the transmitter, note the general condition of the system and check the telescope alignment and the window and optical cleanliness.
2. **Alignment.** On the log sheet, document the initial position of the receiver shelter window with respect to the reticle circle with a "+". Correct the alignment and note the new position on the log sheet. Return the viewing mirror to the proper position.
3. **Timing.** Verify that the lamp turns on at the top of the hour and stays on for the full 16 minutes. This can also be verified at the receiver.
4. **Clean Window.** Clean the window at every site visit. Remove the pane and clean it thoroughly with alcohol and Kimwipes. Visually inspect the telescope objective lens. If the objective lens is dusty, brush lightly with the photographic brush provided. If any smudges or other obstructions exist on the lens, call ARS. Do not clean the objective lens with alcohol. Do not use canned air on the window or lens. Re-check the alignment after cleaning the window.
5. **Lamp Check LED (LPV-2 only).** While the transmitter light is on under automatic control, determine the status of the lamp check LED on the side of the control box. The red LED light should remain off. If the LED is on, call ARS. Do not check the LED light with the test switch.
6. **Lamp Check Status. (LPV-3 only).** Note any error code displayed on the telescope:
 - ER=1 Supply voltage is less than 10.6 volts.
 - ER=2 Maximum safe power to the lamp has been exceeded.
 - ER=3 No zero cross signal detected. Lamp or chopper failure.
 - ER=4 Real Time Chip has lost power and needs to be initialized.
 - ER=5 Temperature of circuit board has exceeded 45°C.
7. **Power Supply Inspection.**
 - At sites with line power, check all surge protector indicator lights to determine if a surge has occurred. If indicator lights are red, call ARS.
 - At sites with lead-acid batteries, visually check the fluid level in the batteries and fill as needed with distilled water. Battery voltage measurements need only be done at the transmitter upon direction of ARS. Clean and inspect the condition of the solar panels.
8. **Final Check.** Verify proper alignment, then return the viewing mirror to the proper position. The knob should be turned fully counter-clockwise. No image should be visible in the eyepiece.
9. **Log Sheet.** Check that the log sheet is fully completed. The yellow copy remains in the shelter; mail or fax the original to ARS.

RECEIVER



LPV-2 and LPV-3 receiver telescope and computer.

Introduction

For correct operation, the receiver must have the proper:

- Alignment
- Timing
- Viewing mirror position
- Window and optical cleanliness
- Switch settings
- Power supply

Servicing Frequency

Both the transmitter and receiver stations should be visited weekly. The transmitter should be visited first. Correct operation of the entire system should be verified shortly thereafter at the receiver. Schedule your servicing visit to arrive at the transmitter shelter 10 minutes before the hour. Log sheets must be completed during each site visit.

Regular Maintenance

The primary receiver servicing tasks are listed below. For detailed descriptions of these tasks and log sheet entries, consult the *Site Operator's Manual for Transmissometer Monitoring Systems*.

1. **Initial Inspection.** Prior to servicing the receiver, note the general condition of the system and check the telescope alignment, the window and optical cleanliness, and the displayed reading. Convert the displayed reading to visual range by turning the A1 switch from C to B, and determine if the reading agrees with the actual conditions (refer to the orange transmissometer reading card). Make sure that the A1 switch is left in the C position after the check.
2. **Alignment.** On the log sheet, document the initial position of the transmitter light source with respect to the reticle circle with a "+". Correct the alignment and note the new position on the log sheet. Return the viewing mirror to the proper position.

3. **Timing.** All times should be synchronized with the National Institute of Standards and Technology (NIST) time. You can synchronize your digital watch to NIST time by calling the NIST recording at 1/303-499-7111 or logging onto <http://www.time.gov>. The system timing is as follows:

HR	MI	SE	Action
XX	00	00	Transmitter light on
XX	03	00	Receiver starts reading
XX	13	20	Receiver finished reading, toggle changes state, and new reading is displayed
XX	16	00	Transmitter light off

4. **Clean Window.** Clean the window at every site visit. Remove the pane and clean it thoroughly with alcohol and Kimwipes. Visually inspect the telescope objective lens. If the objective lens is dusty, brush lightly with the photographic brush provided. If any smudges or other obstructions exist on the lens, call ARS. Do not clean the objective lens with alcohol. Do not use canned air on the window or lens. Re-check the alignment after cleaning the window.
5. **Power Supply Inspection.**
 - At sites with line power, check all surge protector indicator lights to determine if a surge has occurred. If indicator lights are red, call ARS.
 - At sites with lead-acid batteries, visually check the fluid level in the batteries and fill as needed with distilled water. Battery voltage measurements need only be done at the transmitter upon direction of ARS. Clean and inspect the condition of the solar panels.
6. **Final Check.** Verify proper alignment, then return the viewing mirror to the proper position. The knob should be turned fully counter-clockwise. No image should be visible in the eyepiece.
7. **Log Sheet.** Check that the log sheet is fully completed. The yellow copy remains in the shelter; mail or fax the original to ARS.

SPECIAL MAINTENANCE

Special maintenance tasks are discussed in detail in the *Site Operator's Manual for Transmissometer Monitoring Systems*. Call ARS before performing special maintenance.

Timing Reset

When the system timing is correct, the receiver takes a 10-minute averaged reading centered within the 16-minute transmitter lamp-on time. If the receiver toggle light updates more than 5 minutes before the lamp turns off, or less than a minute before the lamp turns off, the system timing needs to be reset.

1. **Transmitter Timing (LPV-2 only).** Remove the control box cover. With the power switch on, push the small reset button at the top of the hour. The light should come on and stay on for 16 minutes.
2. **Transmitter Timing (LPV-3 only).** Before the top of the hour, hold the M (mode) button down until the STOP prompt is received. Press the S(select) button for Y(yes). Press the M button until RST is displayed. With RST displayed, at the top of the hour, press the S button twice to start the cycle clock and an integration. Then press the M button to display RUN, Press the S button to start the transmitter. Other menus that may appear on the display are:

INTG
CYCL
TEST
LAMP
TIME
RST
RUN

3. **Receiver Timing.** Turn the computer off, then on to clear the system computer. The display should go to zeros. At three minutes after the hour (or three minutes after the transmitter light comes on), push the "reset clock" switch up momentarily, then release. At approximately 13 minutes and 20 seconds after the hour, the reading will update and the toggle light should come on.
4. **Setting Your Watch.** You can synchronize your digital watch to National Institute of Standards and Technology (NIST) time by calling the NIST recording at 1/303-499-7111 or logging onto <http://www.time.gov>.
5. **Call ARS.** Notify ARS of the exact time of the timing reset by telephone and note the timing reset on the log sheet. If you are unsure of the procedure, call ARS for direction.

Lamp Changes

Prior to the scheduled lamp change date, ARS will provide the site operator with the next lamp number and its associated calibration number. Lamp changes should be done when visibility conditions are stable. Both the transmitter and receiver must be visited within as short a time as possible. Use extreme care when removing and storing used lamps. The used lamps are required for post-calibration for the system. Label the lamps with ON/OFF dates and times and record lamp changes on the log sheets.

Things to Avoid

1. **Lamp Changes.** The lamp is held into the rear of the transmitter by a friction fit and is removed by pulling it straight out of the transmitter body. On LPV-3 systems, loosen the setscrew at the top before pulling on the lamp. Do not loosen any screws on the lamp alignment plate or the system will need re-calibration.
2. **Transmitter Focus.** Do not change the focus of the transmitter telescope or the system will need re-calibration.
3. **Radio Transmission.** Do not transmit with hand-held radios within 10 feet of either transmissometer component, or the timing may need to be reset.
4. **Computer Resets.** Avoid unnecessary computer resets (OFF/ON) as the timing may be disrupted.

Troubleshooting

The majority of transmissometer problems are caused by:

- Misalignment
- Incorrect system timing
- Incorrect viewing mirror position
- Inadequate power

Check for these potential causes and refer to the *Site Operator's Manual for Transmissometer Monitoring Systems* before calling ARS.

Contact ARS

Please contact us if any questions or problems arise:

Carter Blandford, Karen Rosener, or Jared Merk
Air Resource Specialists, Inc.
1901 Sharp Point Drive, Suite E
Fort Collins, Colorado 80525
970/484-7941

APPENDIX B

Example Completed LPV-2
Transmissometer Transmitter
Log Sheet



LPV-2 TRANSMISSOMETER OPERATOR LOG SHEET
TRANSMITTER STATION

Date 3/15/2003 Local Time 13:40 pm Operator(s) P. Bartell Location Romo
Weather Conditions Overcast, warm, light breeze
Visibility Conditions: Excellent Good Fair Poor Estimated visual range 60 miles
Details Humid haze

INITIAL CONDITION

- Instrument Number LPV- 14
- Mark the INITIAL location of receiver shelter window with a "+" in the circle below.

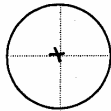

Comments On target

IMPORTANT: Return flip mirror to proper (ON) position.

- Was the alignment corrected? Yes No If Yes, time aligned _____
- Does the instrument appear to be working properly? Yes No
If No, provide details _____

SERVICING

- Initial Window Cleanliness: Good Moderate Poor
Comment _____
- Window Cleaned? Yes No If Yes, time cleaned 13:42
If No, why not? _____
- Lens Inspected? Yes No If Yes, lens cleaned? Yes No
IMPORTANT: Use only the blower brush to clean the telescope lens.
- Solar Panels Cleaned? Yes No Comment _____
- Battery Voltage (charging) 14.6 Battery Voltage (analyzing) 13.8
Battery fluid levels should be checked monthly and filled if low.
- Lamp Check IMPORTANT: Must be done when lamp is ON under automatic control.
a) LED (indicator light on side of control box) On Off (If On, telephone ARS)
b) Lamp Voltage Reading (switch voltmeter to 20 VDC range) 5.95 volts, for lamp number 709
IMPORTANT: Switch voltmeter to "OFF" after taking voltage reading.

TIMING

- Is your watch synchronized with NIST time? (telephone 303-499-7111 or <http://www.time.gov>) Yes No
- Transmitter Light ON, Exact Time, (HR:MIN:SEC) 14:01:38
- Transmitter Light OFF, Exact Time, (HR:MIN:SEC) 14:17:38
- Timing Reset? Yes No If Yes, time transmitter was reset _____
IMPORTANT: THE TRANSMITTER TIMING MUST ONLY BE RESET AT EXACTLY THE TOP OF THE HOUR!

SPECIAL SERVICING (upon ARS instruction)

- Lamp Changed? Yes No If Yes, old lamp number _____ Old lamp voltage _____
Time lamp changed _____ New lamp number _____ New lamp voltage _____
IMPORTANT: If lamp is changed, receiver computer calibration (CAL) number must also be changed.
- Alignment corrected after lamp change? Yes No

GENERAL COMMENTS/SUPPLIES NEEDED

Send the white copy of this form to:
(keep the yellow copy on site)

Air Resource Specialists, Inc.
1901 Sharp Point Drive, Suite E
Fort Collins, CO 80525

Telephone: 1-800-344-5423
Fax: 1-970-484-3423

APPENDIX C

Example Completed LPV-2
Transmissometer Receiver
Log Sheet



LPV-2 TRANSMISSOMETER OPERATOR LOG SHEET
RECEIVER STATION

Date 3/15/2003 Local Time 15:15pm Operator(s) P. Bartell Location ROMO
Weather Conditions Overcast, breezy
Visibility Conditions: Excellent Good Fair Poor Estimated visual range 80 miles
Details Excellent according to transmissometer

INITIAL CONDITION

- Instrument Number LPV- 14
 - Receiver Display Reading 698 Local Time 15:15pm Toggle: On Off
 - Display readings: A1 switch set to: C (raw reading) 698 B(b_{ext} reading) .013
 - Does the b_{ext} reading represent actual conditions? Yes No Comment _____
- IMPORTANT: Return A1 switch to "C" position after check.**
- Settings: Gain .500 Cal 736 Dist 3.91 A1 C A2 SD Int 10 Cycle 1H
 - Mark the INITIAL location of transmitter light source with a "+" in the circle below.

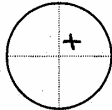

Comments Target is above & to right of center.

IMPORTANT: Return flip mirror to proper (ON) position.

- Was the alignment corrected? Yes No If Yes, time aligned 15:17pm
- Does the instrument appear to be working properly? Yes No
If No, provide details _____

SERVICING

- Initial Window Cleanliness: Good Moderate Poor Comment Almost no dust
 - Window Cleaned? Yes No If Yes, time cleaned 15:18pm If No, why not? _____
 - Lens Inspected? Yes No If Yes, lens cleaned? Yes No
- IMPORTANT: Use only the blower brush to clean the telescope lens.**
- Solar Panels Cleaned? Yes No Comment _____
 - Battery Voltage (charging) 14.6 Battery Voltage (analyzing) 14.1
- Battery fluid levels should be checked monthly and filled if low.**

TIMING

- Is your watch synchronized with NIST time? (telephone 303-499-7111 or <http://www.time.gov>) Yes No
 - Transmitter Light ON, Exact Time, (HR:MIN:SEC) 16:01:38
 - Receiver Toggle Update, Exact Time, (HR:MIN:SEC) 16:16:38
 - Updated Receiver Reading: C(raw reading) 698 B(b_{ext} reading) .013 Toggle: On Off
- IMPORTANT: Return A1 switch to "C" position after check.**
- Does the updated b_{ext} reading represent your estimate of visual range? Yes No
Comment _____
- Transmitter Light OFF, Exact Time, (HR:MIN:SEC) 16:17:38
 - Computer Timing Reset? Yes No If Yes, time reset _____
- IMPORTANT: FOR PROPER RECEIVER COMPUTER TIMING RESET PROCEDURES, CALL ARS.**

SPECIAL SERVICING (upon ARS instruction)

- Lamp Changed at Transmitter Station? Yes No
IMPORTANT: If lamp is changed, receiver computer calibration (CAL) number must also be changed.
- Receiver computer CAL number changed? Yes No If Yes, new CAL number entered: _____

GENERAL COMMENTS/SUPPLIES NEEDED _____

Send the white copy of this form to:
(keep the yellow copy on site)

Air Resource Specialists, Inc.
1901 Sharp Point Drive, Suite E
Fort Collins, CO 80525

Telephone: 1-800-344-5423
Fax: 1-970-484-3423

TABLE OF CONTENTS

<u>Section</u>		<u>Page</u>
1.0	PURPOSE AND APPLICABILITY	1
2.0	RESPONSIBILITIES	4
2.1	Project Manager	4
2.2	Field Specialist	4
2.3	Data Analyst	4
2.4	Site Operator	5
3.0	REQUIRED EQUIPMENT AND MATERIALS	5
4.0	METHODS	6
4.1	Routine Servicing	6
4.1.1	Routine Servicing at the Transmitter Station	9
4.1.1.1	Initial Condition	10
4.1.1.2	Servicing	13
4.1.1.3	Timing	14
4.1.1.4	Special Servicing	14
4.1.2	Routine Servicing at the Receiver Station	15
4.1.2.1	Initial Condition	15
4.1.2.2	Servicing	18
4.1.2.3	Timing	21
4.1.2.4	Air Temperature/Relative Humidity	22
4.1.2.5	Special Servicing	22
4.2	Intermittent Servicing and Maintenance	22
4.2.1	Checking and Resetting System Timing	22
4.2.2	Transmitter Lamp Changes	24
4.2.3	AC Power System Servicing	26
4.3	Problems or Questions	27
4.4	Handling Log Sheets	27
APPENDIX A	OPTEC LPV TRANSMISSOMETER OPERATOR'S GUIDE	A-1
APPENDIX B	EXAMPLE COMPLETED LPV-3 TRANSMITTER LOG SHEET	B-1
APPENDIX C	EXAMPLE COMPLETED LPV-3 RECEIVER LOG SHEET	C-1

LIST OF FIGURES

<u>Figure</u>		<u>Page</u>
4-1	LPV-3 Transmissometer Operator Log Sheet – Transmitter Station	7
4-2	LPV-3 Transmissometer Operator Log Sheet – Receiver Station	8
4-3	LPV-3 Transmitter Components Diagram	11
4-4	Extinction (b_{ext}) to Visual Range Conversion Chart	17
4-5	Junction Box Connector Panel	20

LIST OF TABLES

<u>Table</u>		<u>Page</u>
1-1	Transmissometer Servicing Schedule	1
1-2	Transmissometer Transmitter Station, Summary of Servicing Tasks	2
1-3	Transmissometer Receiver Station, Summary of Servicing Tasks	3

1.0 PURPOSE AND APPLICABILITY

This technical instruction (TI) describes the steps of a routine site operator maintenance visit to an Optec LPV-3 transmissometer station (LPV-2 receiver and LPV-3 transmitter) operated according to IMPROVE Protocol. The purpose of routine site operator maintenance is to assure quality data capture and minimize data loss by performing and documenting scheduled operational checks and preventive maintenance on transmissometers, meteorological sensors, data acquisition and control systems, power systems, and support equipment. The transmissometer servicing schedule is provided in Table 1-1.

This TI, as referenced from Standard Operating Procedure (SOP) 4110, *Transmissometer Maintenance (IMPROVE Protocol)*, specifically describes the service and maintenance procedures to be performed at the transmissometer transmitter and receiver stations. Summaries of the servicing procedures are provided in Tables 1-2 and 1-3, for the transmitter and receiver stations, respectively. Tasks are listed in the suggested order of completion. For more detailed instructions, see Section 4.0.

Due to variations in the site configurations of IMPROVE Protocol sites, portions of this TI may not apply to every transmissometer station.

Table 1-1

Transmissometer Servicing Schedule

INTERVAL	SERVICING TASKS
7- to 10-day interval	<p>Complete the servicing tasks listed on the transmissometer log sheets.</p> <p>Both the transmitter and receiver shelters must be visited; the transmitter should be serviced first. Correct operation of the system should be verified at the receiver shortly afterward (same day).</p> <p>If the system is operated in a cycled mode, the transmitter and receiver system timing should be checked at each site visit.</p> <p>The datalogging system should be checked at each site visit.</p>
Monthly interval	<p>If the transmissometer system is operated in continuous mode, the transmitter lamps should be changed monthly. ARS will notify the site operators when a lamp change is needed.</p>
2-month interval	<p>If the transmissometer system is operated in a cycled mode, transmitter lamps should be changed every two months. ARS will notify site operators when a lamp change is needed.</p>
Annual interval	<p>Field specialists will make visits once a year to exchange the existing transmissometer system for a newly serviced and calibrated system.</p> <p>Training of site operators in the servicing and maintenance of the monitoring system components will take place during annual field specialist visits.</p>

Table 1-2

Transmissometer Transmitter Station
Summary of Servicing Tasks

ORDER OF COMPLETION	SERVICING TASKS
Before leaving the office	<p>If the transmissometer system is operated in a cycled mode, schedule your servicing trip to be at the transmitter station 10 minutes before the top of the hour. Servicing tasks should be performed before the top of the hour.</p> <p>When checking the system timing, set your digital watch to the correct time prior to leaving the office by calling the National Institute of Standards and Technology (NIST) recording 1-303/499-7111 (Boulder, CO), or logging onto http://www.time.gov.</p>
At the transmitter station (complete the servicing tasks listed on the log sheet)	<p>Complete the log sheet general information section.</p> <p>Document the initial alignment conditions and/or comment.</p> <p>Record whether the instrument appears to be working properly, and comment.</p> <p>Inspect and document the window cleanliness.</p> <p>Clean the window and comment as necessary. Recheck alignment.</p> <p>Inspect and document telescope lens cleanliness.</p> <p>Clean the lens if needed and recheck the alignment.</p> <p>If the transmissometer system is operated in a cycled mode, observe and record the transmitter "on" and "off" times.</p> <p>Document if the system timing was reset.</p> <p>Record special servicing tasks: lamp change (time of change and lamp number).</p> <p>Check supply inventory. Request needed supplies on the log sheet.</p> <p>Record any comments on the log sheet.</p> <p>Leave a copy of the log sheet in the shelter; take the original back to the office.</p> <p>Double-check the alignment and the flip mirror position before leaving the shelter.</p>
Back at the office	<p>Send original log sheets from both the transmitter and receiver to ARS.</p> <p>Call an ARS field specialist or data analyst promptly if a problem or need arises.</p>

Table 1-3

Transmissometer Receiver Station
Summary of Servicing Tasks

ORDER OF COMPLETION	SERVICING TASKS
Before leaving the office	<p>If the transmissometer system is operated in a cycled mode, schedule your servicing trip to be at the receiver station 10 minutes before the hour. Servicing tasks should be performed before the top of the hour. System timing and the updated reading should be observed before leaving.</p> <p>When checking the system timing, set your digital watch to the correct time prior to leaving the office by calling the National Institute of Standards and Technology (NIST) recording 1-303/499-7111 (Boulder, CO), or logging onto http://www.time.gov.</p>
At the receiver station (complete the servicing tasks listed on the log sheet)	<p>Complete the log sheet general information section.</p> <p>Record the instrument number, local time, and toggle state.</p> <p>Record the receiver computer settings.</p> <p>Record the A1 switch readings for the "B", "C", and "VR" positions.</p> <p>Compare the b_{ext} readings to actual visual conditions and comment.</p> <p>Document the initial alignment conditions and/or comment.</p> <p>Document if the alignment was corrected.</p> <p>Inspect and document the window cleanliness. Clean the window and recheck alignment.</p> <p>Inspect and document telescope lens cleanliness.</p> <p>Clean the lens if needed and recheck alignment.</p> <p>Document whether the junction box voltage lamp is illuminated.</p> <p>Document the datalogger date and time.</p> <p>Record datalogger parameters.</p> <p>If the transmissometer system is operated in a cycled mode, observe and record the transmitter light "on" time.</p> <p>Observe and record the toggle update time.</p> <p>Note the updated receiver reading and record. Also, compare the reading to actual visibility conditions to see if they match conditions.</p> <p>If the transmissometer system is operated in a cycled mode, observe and record the transmitter light "off" time.</p> <p>Record if the computer timing was reset.</p> <p>Compare the air temperature and relative humidity readings to actual conditions.</p> <p>Record operation of the housing fan and condition of the inlet screen.</p> <p>Record special servicing tasks: lamp changes and cal # changes.</p> <p>Check supply inventory. Request needed supplies on the log sheet.</p> <p>Record any comments on the log sheet. Leave a copy of the log sheet in the shelter. Take the original back to the office.</p> <p>Double-check the alignment and the flip mirror position before leaving the shelter.</p>
Back at the office	<p>Send original log sheets from both the receiver and transmitter to ARS.</p> <p>Call an ARS field specialist or data analyst promptly if a problem or need arises.</p>

2.0 RESPONSIBILITIES

2.1 PROJECT MANAGER

The project manager shall:

- Coordinate with the site operator, his/her supervisor, field specialist, and data analyst concerning the schedule and requirements for routine maintenance.
- Oversee and review documentation completed by the site operator for accuracy and completeness.

2.2 FIELD SPECIALIST

The field specialist shall:

- Coordinate with the site operator, his/her supervisor, project manager, and data analyst concerning the schedule and requirements for routine maintenance.
- Train the site operator in all phases of the routine maintenance and special servicing procedures necessary for site visits.
- Provide technical support to the site operator via telephone to assure high quality site visits.
- Document all technical support provided to the site operator.
- Resolve problems reported by the site operator.

2.3 DATA ANALYST

The data analyst shall:

- Coordinate with the site operator, his/her supervisor, project manager, and field specialist concerning the schedule and requirements for routine maintenance.
- Review documentation completed by the site operator for accuracy and completeness.
- Verify that scheduled visits are performed and notify the site operator if he/she fails to make a scheduled visit.
- Provide technical support to the site operator via telephone to assure high quality site visits.
- Document all technical support provided to the site operator.

- Review and file all site documentation.
- Resolve problems reported by the site operator.
- Ship cleaning and other necessary supplies for routine maintenance to the site operator.
- Enter all correspondence with site operators and the results of all performed procedures into the site-specific timeline.

2.4 SITE OPERATOR

The site operator shall:

- Coordinate with his/her supervisor, project manager, field specialist, and data analyst concerning the schedule and requirements for routine maintenance.
- Perform all procedures described in this TI.
- Thoroughly document all procedures on the LPV-3 Transmissometer Operator Log Sheet and mail and fax the log sheet to the data analyst.
- Report any noted inconsistencies immediately to the data analyst or field specialist.

3.0 REQUIRED EQUIPMENT AND MATERIALS

The equipment generally required to support a weekly site visit includes:

- Medium and small flat-blade screwdriver
- Medium adjustable wrench
- Keys for shelters and padlocks
- Voltmeter and cables
- Isopropyl alcohol and Kimwipes
- Glass cleaner and paper towels
- Photographic (blower) brush
- Wire brush
- Flashlight and/or signal mirror

- Site Operator's Manual for Transmissometer Monitoring Systems
- LPV Transmissometer Operator's Guide
- LPV-3 Transmissometer Operator Log Sheets (transmitter and receiver)
- Pen or pencil
- Notebook for yellow copies of log sheets
- Digital watch

4.0 METHODS

This section includes four (4) major subsections:

- 4.1 Routine Servicing
- 4.2 Intermittent Servicing and Maintenance
- 4.3 Problems or Questions
- 4.4 Handling Log Sheets

The procedures described in these sections refer to specific instrument components. Detailed schematic diagrams and instrument component descriptions are provided for reference in TI 4110-3350, *Transmissometer Monitoring System Diagrams and Component Descriptions*. Resolution of problems noted during routine or intermittent servicing can be more fully investigated by following the troubleshooting procedures defined in TI 4110-3305, *Troubleshooting and Emergency Maintenance Procedures for Optec LPV-3 Transmissometer Systems (IMPROVE Protocol)*.

4.1 ROUTINE SERVICING

This subsection describes transmissometer monitoring system routine servicing tasks and log sheet entries. A log sheet is required for both the transmitter and receiver stations (see Figures 4-1 and 4-2). The transmissometer operator log sheets are divided into five (5) main sections:

- Initial Condition
- Servicing
- Timing
- Air Temperature/Relative Humidity
- Special Servicing



LPV-3 TRANSMISSOMETER OPERATOR LOG SHEET
TRANSMITTER STATION

Date _____ Local Time _____ Operator(s) _____ Location _____
Weather Conditions _____
Visibility Conditions: Excellent Good Fair Poor Estimated visual range _____ miles
Details _____

INITIAL CONDITION

- Instrument Number LPV- _____ Display Screen _____ Lamp Number _____
- Mark the INITIAL location of receiver shelter window with a "+" in the circle below.

Comments _____
- Initial Window Cleanliness: Good Moderate Poor
Comment _____
- Does the instrument appear to be working properly? Yes No Details: _____

IMPORTANT: RETURN FLIP MIRROR TO PROPER (ON) POSITION.

SERVICING

- Was the alignment corrected? Yes No If Yes, time aligned _____
- Window Cleaned? Yes No If Yes, time cleaned _____
- Lens Inspected? Yes No If Yes, lens cleaned? Yes No

IMPORTANT: USE ONLY THE BLOWER BRUSH TO CLEAN THE TELESCOPE LENS.

TIMING

- Is your watch synchronized with NIST time? (telephone 303-499-7111 or <http://www.time.gov>) Yes No
- Transmitter Light ON, Exact Time, (HR:MIN:SEC) _____:_____:_____
- Transmitter Light OFF, Exact Time, (HR:MIN:SEC) _____:_____:_____
- Timing Reset? Yes No If Yes, time transmitter was reset _____

IMPORTANT: THE TRANSMITTER TIMING MUST ONLY BE RESET AT EXACTLY THE TOP OF THE HOUR!

SPECIAL SERVICING (upon ARS instruction)

- Lamp Changed? Yes No
Time lamp changed _____ New lamp number _____

IMPORTANT: IF LAMP IS CHANGED, RECEIVER COMPUTER CALIBRATION (CAL) NUMBER MUST ALSO BE CHANGED.

- Alignment corrected after lamp change? Yes No

GENERAL COMMENTS/SUPPLIES NEEDED

Send the white copy of this form to:
(keep the yellow copy on site)

Air Resource Specialists, Inc.
1901 Sharp Point Drive, Suite E
Fort Collins, CO 80525

Telephone: 1-800-344-5423
Fax: 1-970-484-3423

Figure 4-1. LPV-3 Transmissometer Operator Log Sheet - Transmitter Station.



**LPV-3 TRANSMISSOMETER OPERATOR LOG SHEET
RECEIVER STATION**

Date _____ Local Time _____ Operator(s) _____ Location _____
Weather Conditions _____
Visibility Conditions: Excellent Good Fair Poor Estimated visual range _____ miles
Details _____

INITIAL CONDITION

- Instrument Number LPV- _____ Local Time _____ Toggle: On Off
- Settings: Gain _____ Cal _____ Path _____ A1 _____ A2 _____ Integ _____ Cycle _____
- Switch A1 readings: B (b_{ext} reading) _____ C (raw reading) _____ VR(visual range km) _____
- Does the b_{ext} reading represent actual conditions? Yes No Comment _____

IMPORTANT: RETURN A1 SWITCH TO "C" (CYCLED MODE) OR "B" (CONTINUOUS MODE) AFTER CHECK.

- Mark the INITIAL location of transmitter light source with a "+" in the circle below.
Comments _____

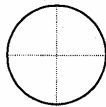

IMPORTANT: RETURN FLIP MIRROR TO PROPER (ON) POSITION.

- Initial Window Cleanliness: Good Moderate Poor Comment _____
- Does the instrument appear to be working properly? Yes No Details: _____
- Are all cables and connectors secure? Yes No Details: _____

SERVICING

- Was the alignment corrected? Yes No If Yes, time aligned _____
 - Window Cleaned? Yes No If Yes, time cleaned _____
 - Lens Inspected? Yes No If Yes, lens cleaned? Yes No
- IMPORTANT: USE ONLY THE BLOWER BRUSH TO CLEAN THE TELESCOPE LENS.**
- Is the junction box voltage lamp illuminated green? Yes No
 - Is the datalogger date and time correct? Yes No Comment _____
 - Record datalogger readings: *61A 01: _____ Ambient temperature (°C) A 05: _____ Toggle
A 02: _____ Relative humidity (%) *68A 08: _____ Internal battery voltage
A 03: _____ Extinction (1/km) A 09: _____ Power supply voltage
A 04: _____ Raw reading (counts)

IMPORTANT: RETURN THE DATALOGGER TO RUN MODE (*0).

TIMING

- Is your watch synchronized with NIST time? (telephone 303-499-7111 or <http://www.time.gov>) Yes No
 - Transmitter Light ON, Exact Time, (HR:MIN:SEC) _____:_____:_____
 - Receiver Toggle Update, Exact Time, (HR:MIN:SEC) _____:_____:_____
 - Transmitter Light OFF, Exact Time, (HR:MIN:SEC) _____:_____:_____
 - Updated Receiver Reading: C(raw reading) _____ B(b_{ext} reading) _____ Toggle: On Off
- IMPORTANT: RETURN A1 SWITCH TO "C" (CYCLED MODE) OR "B" (CONTINUOUS MODE) AFTER CHECK.**
Does the updated b_{ext} reading represent your estimate of visual range? Yes No
Comment _____
- Computer Timing Reset? Yes No If Yes, time reset _____
- IMPORTANT: FOR PROPER RECEIVER COMPUTER TIMING RESET PROCEDURES, CALL ARS.**

AIR TEMPERATURE / RELATIVE HUMIDITY

- Do the datalogger AT/RH readings represent actual conditions? Yes No Comment _____
- Is the AT/RH aspiration fan operating? Yes No Comment _____
- Is the inlet screen clean? Yes No Comment _____

SPECIAL SERVICING (upon ARS instruction)

- Lamp changed at transmitter station? Yes No If yes, new lamp number _____
IMPORTANT: IF LAMP IS CHANGED, RECEIVER COMPUTER CALIBRATION (CAL) NUMBER MUST ALSO BE CHANGED.
- Receiver computer CAL number changed? Yes No If Yes, new CAL number entered: _____

GENERAL COMMENTS/SUPPLIES NEEDED _____

Send the white copy of this form to:
(keep the yellow copy on site)

Air Resource Specialists, Inc.
1901 Sharp Point Drive, Suite E
Fort Collins, CO 80525

Telephone: 1-800-344-5423
Fax: 1-970-484-3423

Figure 4-2. LPV-3 Transmissometer Operator Log Sheet - Receiver Station.

The initial condition, servicing, air temperature/relative humidity, and timing sections are a part of routine servicing and should be completed during every site visit. Special servicing includes tasks that are normally performed in response to a request by the data analyst. Procedures related to special servicing tasks are presented in Section 4.2, Intermittent Servicing and Maintenance.

An operator's guide to transmissometer servicing has been prepared as a field reference for routine servicing; a copy of the guide is provided in Appendix A. Operator log sheets are shown as Figures 4-1 and 4-2, and examples of completed log sheets are included in Appendices B (Transmitter), and C (Receiver).

The transmissometer circuitry, especially the internal auto-timers, can be adversely affected by strong radio signals. Do not transmit on a hand-held radio within 10 feet of the transmitter and avoid aiming the antenna at or over the circuitry. Strong radio signals may reset the internal auto-timer, resulting in incorrect system timing.

Before leaving the office, set your digital watch to the correct time by calling the National Institute of Standards and Technology (NIST) recording 1-303/499-7111 (Boulder, CO), or logging onto <http://www.time.gov>.

4.1.1 Routine Servicing at the Transmitter Station

The following general information appears at the top of the transmitter log sheet.

LOCATION	Enter either the full location name or the four-letter site abbreviation.
DATE	Use the standard calendar date, not the Julian date.
LOCAL TIME	Current local time in 24-hour format should be used. Use Daylight Saving Time when applicable. The operator's watch should be set to the correct time prior to leaving the office by calling NIST (see above).
OPERATOR(S)	Use your full name, or your first initial and last name.
WEATHER CONDITIONS	Describe current or recent weather conditions that may be helpful in interpreting the transmissometer readings. Such conditions may include, but are not limited to: <ul style="list-style-type: none">• Passing storm fronts• Impending precipitation• Precipitation events• Stagnant air masses• High winds• Fog

VISIBILITY CONDITIONS Record whether the visibility conditions are excellent, good, fair, or poor, and estimate the visual range.

Describe current or recent visibility conditions that may be useful in verifying correct transmissometer operation. A partial list of such conditions includes:

- Extremely clean
- Plumes visible
- Control burns
- Widespread, uniform haze
- Haze layers

4.1.1.1 Initial Condition

Refer to Figure 4-3 for transmitter component locations.

INSTRUMENT NUMBER Record the LPV instrument number. The number can be found on stickers affixed to both the control box and the telescope.

DISPLAY SCREEN Check the display located on the lamp housing panel for any errors. Possible error codes include:

ER=1

Usually indicates that the power supply voltage from a battery is failing (less than 10.6 volts). Recharge the battery.

ER=2

The maximum safe power to the lamp has been exceeded. Replace the lamp.

ER=3

No signal is detected by the photodarlington. This indicates either a lamp or chopper failure. Check the lamp first, and then the chopper for proper operation.

- Is the lamp burned out or has the filament been damaged? If the lamp filament is broken, the power supply to the instrument should be turned off and the lamp should be removed. Telephone ARS for further instructions.
- Can you hear the chopper motor running? If the chopper doesn't appear to be operating correctly, telephone ARS for further instructions.

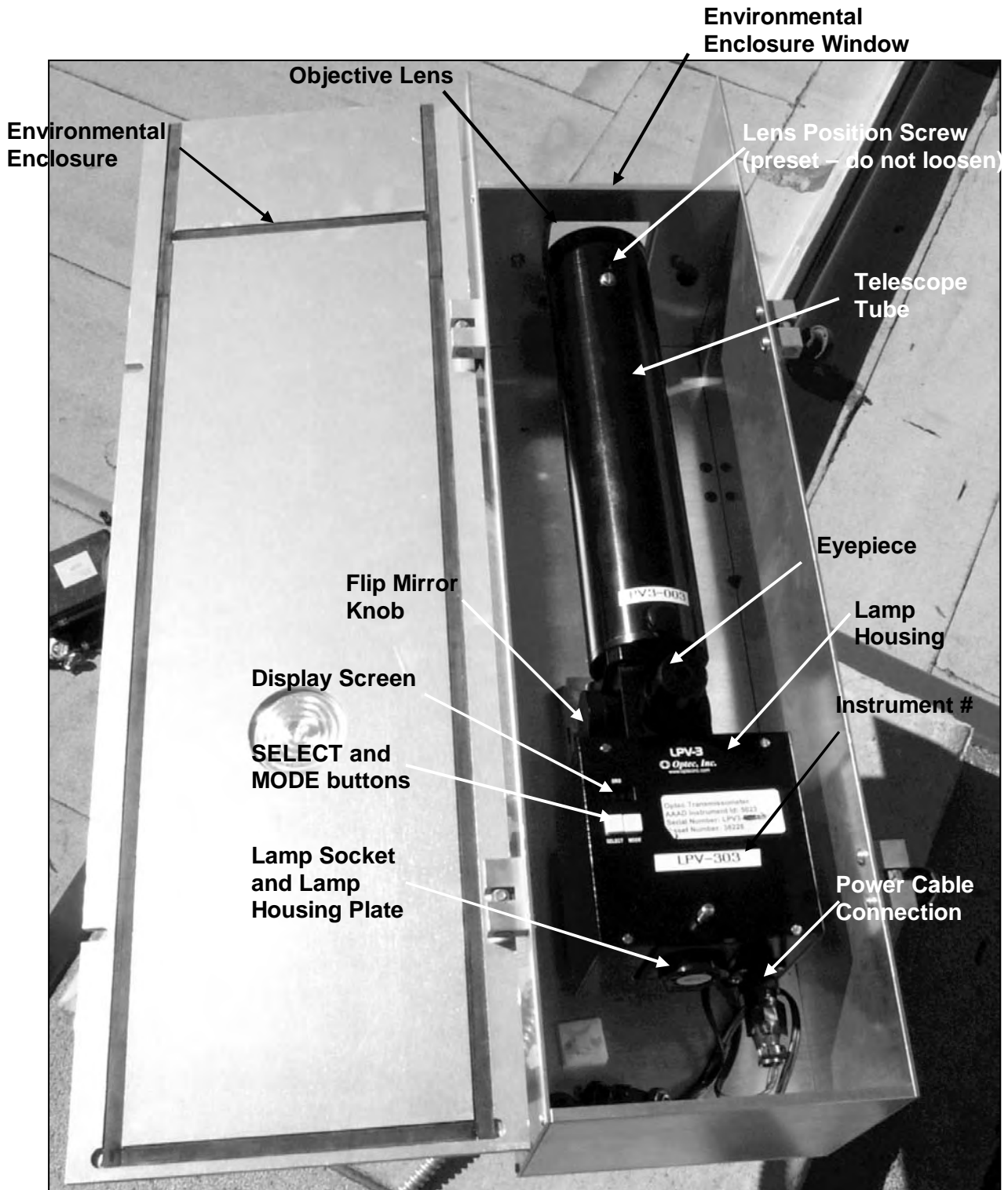

Figure 4-3. LPV-3 Transmitter Components Diagram.

DISPLAY SCREEN
(continued)

ER=4

The Real Time Chip has lost power and needs to be initialized. Call ARS for further instructions.

ER=5

This error code will only be displayed in the event that the transmitter operates in a cycled mode and the temperature of the circuitboard has exceeded 45 degrees Celsius. Call ARS for further instructions.

LAMP NUMBER

Document the lamp number that is currently being used.

INITIAL ALIGNMENT

To check the alignment, turn the flip mirror knob fully clockwise against the stop to the OFF position. Document the position of the receiver shelter window with respect to the circle on the log sheet with a "+". The receiver should be at the intersection of the "+".

If an initial alignment check is impossible due to weather, haze, turbulence, or lighting conditions, return the flip mirror to the ON position – Do not attempt to align. Record pertinent comments regarding alignment problems to the right of the circle on the log sheet.

Note: If the transmissometer system is operating in a cycled mode, avoid making alignment checks or adjustments while the transmitter is on. If the flip mirror knob is moved from the ON position to the OFF position while the receiver is making a reading, the extinction reading for that hour will not be valid. If a reading has been affected by an alignment check, note this in the log sheet comment section.

INITIAL WINDOW
CLEANLINESS

Remove the windowpane from its frame and visually inspect it for water drop deposits, film, unusually heavy dust, and insects or pests that may reduce the transmission of light through the glass. Make comments when applicable. It is most important to inspect the portion of the glass pane that is directly in front of the transmitter lens.

OPERATIONAL
CONDITION

A general overview of the shelter or environmental enclosure, instrument, and support equipment should be made to ensure that the system appears to have operated properly since the last servicing visit. Thoroughly document any noted inconsistencies.

4.1.1.2 Servicing

CORRECTING ALIGNMENT

If the alignment has drifted so that the receiver is not in the center of the reticle circle, adjust the alti-azimuth base controls to center the receiver. Make sure the flip mirror knob is fully against the stop while aligning. Do this only after the initial alignment has been documented.

The circle depicted on the log sheet represents the small, inner reticle circle. The inner reticle circle must remain aligned on the receiver telescope for correct instrument operation.

One of your eyes will be dominant; if you have difficulty viewing the scene, try it using your other eye. Some operators find it easier to view the scene from behind the telescope while others prefer to view from the side.

Schedule site visits for times of the day with the best viewing conditions. All shelters are equipped with signal mirrors and flashlights for occasions when alignment checks are made with operators at both stations. Finally, keep the eyepiece clean for better viewing.

If the alignment was corrected after the initial alignment documentation, mark **YES** and document the time it was corrected in the space provided. If the alignment was not corrected, mark **NO**.

CLEAN WINDOW

The shelter or enclosure window should be cleaned during every site visit. If for some reason the window is not cleaned, document its condition in the comments section. Document the time that the window was cleaned in the space provided. To clean the window:

- Remove the windowpane from the frame.
- Inspect the hood and frame for spider webs.
- Use only Kimwipes and alcohol to clean both sides of the glass. Use plenty of cleaning fluid, change Kimwipes often, and use a light hand.
- Reinstall the windowpane after inspecting for smears, smudges, etc.
- Recheck the alignment.

CLEAN WINDOW
(continued)

Note: Do not use canned air to clean the windows or objective lens. The objective in cleaning optical surfaces is to remove the abrasive dust particles and film without damaging the glass surface. Always remove the large particles first and progress toward the removal of films. Use a light touch, plenty of cleaning fluid, and frequent changes of cleaning paper. Clean with a circular, rubbing motion.

INSPECT LENS

Remove the shelter or enclosure window and look closely at the transmitter telescope lens from a number of angles. Note any accumulation of dust, dirt, smudges, or other foreign material on the lens. If any accumulation is noted, use the blower brush to clean the objective lens. Use a light touch. If an accumulation on the lens cannot be removed with the blower brush, call ARS for further instructions. Also, use the blower brush to remove dust from the body of the transmitter telescope. Clean the eyepiece with alcohol and Kimwipes. Use only the blower brush to clean the objective lens.

4.1.1.3 Timing

CHECK TIMING
(if applicable)

Document whether or not your watch is synchronized with NIST time by marking **YES** or **NO**. Observe and document the exact time the transmitter light comes on and goes off in the spaces provided.

RESET TIMING

For sites that operate in a cycled mode, procedures for checking and resetting the transmitter internal auto-timer are described in Section 4.2.1. Document the results of a timing check before resetting the time. If the time is reset, document it on the log sheet. Timing checks should be made during each site visit.

4.1.1.4 Special Servicing

CHANGE LAMP

Procedures for changing lamps are described in Section 4.2.2. If a lamp change is made, document the time the lamp was changed, and the new lamp number. The lamp number is located on a sticker attached to the back of the lamp.

RECHECK ALIGNMENT

Changing the lamp can result in telescope movement and misalignment. Always recheck alignment after a lamp change and make sure to return the flip mirror to the correct position before leaving the site.

GENERAL COMMENTS /
SUPPLIES NEEDED

Space for additional comments is provided at the bottom of the log sheet. This space should also be used to request additional servicing supplies.

4.1.2 Routine Servicing at the Receiver Station

The following general information appears at the top of the receiver log sheet.

LOCATION	Enter either the full location name or the four-letter site abbreviation.
DATE	Use the standard calendar date, not the Julian date.
LOCAL TIME	Current local time in 24-hour format should be used. Use Daylight Saving Time when applicable. The operator's watch should be set to the correct time prior to leaving the office by calling NIST (see above).
OPERATOR(S)	Use your full name, or your first initial and last name.
WEATHER CONDITIONS	Describe current or recent weather conditions that may be helpful in interpreting the transmissometer readings. Such conditions may include, but are not limited to: <ul style="list-style-type: none">• Passing storm fronts• Impending precipitation• Precipitation events• Stagnant air masses• High winds• Fog
VISIBILITY CONDITIONS	Record whether the visibility conditions are excellent, good, fair, or poor, and estimate the visual range. Describe current or recent visibility conditions that may be useful in verifying correct transmissometer operation. A partial list of such conditions includes: <ul style="list-style-type: none">• Extremely clean• Plumes visible• Control burns• Widespread, uniform haze• Haze layers

4.1.2.1 Initial Condition

INSTRUMENT NUMBER	Record the LPV instrument number. The number can be found on stickers affixed to the receiver computer and telescope.
TIME AND TOGGLE	Record the current local time, and whether or not the toggle light is on.

COMPUTER SETTINGS	Record the position or numerical display of each of the receiver computer front panel switches (Gain, Cal, Path, A1, A2, Integ, and Cycle).
SWITCH SETTINGS	Record the reading of the A1 switch in the “B” (b_{ext} reading), “C” (raw reading), and VR (visual range km) positions. Return the switch to the “C” position for cycled mode or “B” for continuous mode operation.
ACTUAL CONDITIONS	Use the orange conversion chart (Figure 4-4) to convert b_{ext} to visual range. Compare this value with the actual visibility conditions. If the reading does not correspond with the actual conditions, note the inconsistency in the comments section and call ARS.
INITIAL ALIGNMENT	<p>To check the alignment, turn the flip mirror knob fully clockwise against the stop to the OFF position. Document the position of the transmitter with respect to the circle on the log sheet with a “+”. The light source would be at the intersection of the “+”.</p> <p>In an alignment check is impossible due to weather, haze, turbulence, or lighting conditions, return the flip mirror to the ON position – <u>Do not</u> attempt to align. Record pertinent comments regarding alignment problems to the right of the circle on the log sheet.</p> <p>Note: If the transmissometer system is operating in a cycled mode, avoid making alignment checks or adjustments while the transmitter is on. When viewing conditions are marginal, use the transmitter light source as an aid in alignment. The receiver can be placed in the OFF position for a short time immediately after the transmitter turns on, or following a toggle and reading update, without affecting a measurement. Document any interruption of a reading on the log sheet.</p>
INITIAL WINDOW CLEANLINESS	Visually inspect the shelter or enclosure window for water drop deposits, film, unusually heavy dust, and insects or pests that may reduce the transmission of light through the glass. Make comments when applicable. It is most important to inspect the glass directly in front of the receiver lens.
OPERATIONAL AND PHYSICAL CONDITION	A general overview of the shelter, instrument, datalogging system, and support equipment should be made to ensure that the system appears to have operated properly since the last servicing visit. Thoroughly document any accumulation of dirt or other contamination, damage, or other physical problems regarding the system.

DOES THE CURRENT TRANSMISSOMETER READING MAKE SENSE?

CONVERT THE COMPUTER-DISPLAYED READING TO VISUAL RANGE USING THE CHART BELOW.
DOES THIS VALUE AGREE WITH THE CURRENT VISIBILITY CONDITIONS?

IF NOT, CHECK

- FLIP MIRROR
- ALIGNMENT
- TIMING

IF THE PROBLEM CANNOT BE RESOLVED, CALL ARS AT 970-484-7941

COMPUTER DISPLAY B_{ext} (KM ⁻¹)	VISUAL RANGE (KILOMETERS)	VISUAL RANGE (MILES)
.010	391	243
.015	261	162
.020	196	122
.025	156	97
.030	130	81
.035	112	69
.040	98	61
.045	87	54
.050	78	49
.060	65	41
.070	56	35
.080	49	30
.090	43	27
.100	39	24
.200	20	12
.300	13	8
.400	10	6
.500	8	5
.600	7	4
.700	6	3
.800	5	3
.900	4	3
1.000	<4	<3

Figure 4-4. Extinction (b_{ext}) to Visual Range Conversion Chart.

CABLES AND CONNECTORS

The receiver system cables connect the receiver computer to the receiver telescope, datalogging system, and DC power. Verify that all cables are secure and check the integrity of the cables. Document any problems, including broken connectors, loose or bare wires, etc.

The datalogging system cables connect the datalogging system to the transmissometer receiver, AT/RH sensor, telephone line, DC power, and computer interface (if present) through connectors on the bottom of the enclosure. Check the cables and connectors. Verify that all cables are secure and check the integrity of the cables. Document any problems, including broken connectors, loose or bare wires, etc.

Report any problems promptly to ARS.

4.1.2.2 Servicing

CORRECTING ALIGNMENT

If the alignment has drifted so that the transmitter is not in the center of the reticle circle, adjust the alti-azimuth base controls to center the transmitter. Make sure the flip mirror knob is fully against the stop while aligning. Do this only after the initial alignment has been documented.

The circle depicted on the log sheet represents the reticle circle. The reticle circle must remain aligned on the transmitter for correct instrument operation.

If the alignment was corrected after the initial alignment documentation, mark **YES** and document the time it was corrected in the space provided. If the alignment was not corrected, mark **NO**.

CLEAN WINDOW

The shelter or enclosure window should be cleaned during every site visit. If for some reason the window is not cleaned, document its condition in the comments section. Document the time that the window was cleaned in the space provided. To clean the window:

- Remove the windowpane from the frame.
- Inspect the hood and frame for spider webs.
- Use only Kimwipes and alcohol to clean both sides of the glass. Use plenty of cleaning fluid, change Kimwipes often, and use a light hand.

CLEAN WINDOW
(continued)

- Reinstall the windowpane after inspecting for smears, smudges, etc.
- Recheck alignment.

Note: Do not use canned air to clean the windows or objective lens. The objective in cleaning optical surfaces is to remove the abrasive dust particles and film without damaging the glass surface. Always remove the large particles first and progress toward the removal of films. Use a light touch, plenty of cleaning fluid, and frequent changes of cleaning paper. Clean with a circular, rubbing motion.

INSPECT LENS

Remove the shelter or enclosure window and look closely at the receiver telescope objective lens from a number of angles. Note any accumulation of dust, dirt, smudges, or other foreign material on the lens. If any accumulation is noted, use the blower brush to clean the objective lens. Use a light touch. If an accumulation on the lens cannot be removed with the blower brush, call ARS for further instructions. Also, use the blower brush to remove dust from the body of the transmitter telescope. Clean the eyepiece with alcohol and Kimwipes. Use only the blower brush to clean the objective lens.

GREEN INDICATOR
LAMP

The green indicator lamp on the junction box connector panel in the datalogging and support system enclosure (see Figure 4-5) indicates whether or not the datalogging system's 13.8 volt DC power supply is operating. If the green indicator lamp is not illuminated, check to see if the DC fuse is blown. If the DC fuse is blown, replace it with a 7-amp AGC fast-blow glass fuse. If the fuse blows again, do not replace it. Call ARS immediately whenever a fuse has blown.

DATALOGGER DATE
AND TIME

The 23X datalogger keeps track of the date in Julian date and year format. The date and time functions are accessed by entering *5 on the 23X keypad and entering A to advance through the parameters.

Checking/setting the time

Access the 23X time mode by entering *5 on the 23X keypad.

The 23X datalogger time should only be set if it differs by more than one minute from NIST time. To set the time, advance to the time set display by entering *5AAA. Enter the correct time at the top of a minute as HH:MM and press A to input the change. Press *5 to verify that the time change was entered properly and is now synchronized with NIST time.

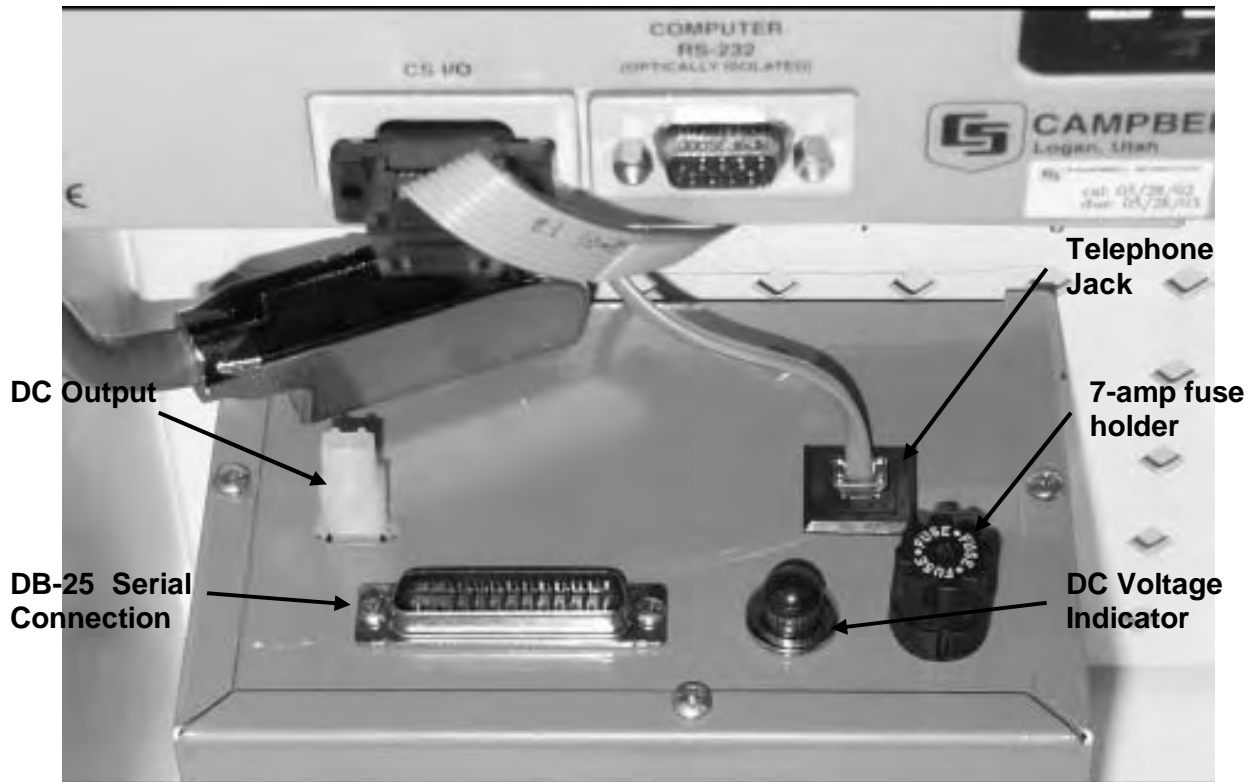

Figure 4-5. Junction Box Connector Panel.

DATALOGGER DATE
AND TIME (continued)

Checking/setting the year

Advance to the year by entering **A**. If the year is incorrect, enter the correct year on the keypad and press **A** to input the change.

Checking/setting the Julian date

Advance to the Julian date by entering **A**. If the Julian date is incorrect (refer to a Julian date calendar), enter the correct Julian date on the keypad and press **A** to input the change.

DATALOGGER STORAGE
LOCATIONS

Log the following current readings from the 23X datalogger intermediate storage locations by entering ***6** on the 23X keypad to access the locations, and entering **A** to advance through the locations.

<u>Key Sequence</u>	<u>Display</u>	<u>Measurement Parameter</u>
*61A	01:_____	Ambient temperature (°C)
A	02:_____	Relative humidity (%)
A	03:_____	Transmissometer extinction (1/km)
A	04:_____	Transmissometer raw reading (counts)
A	05:_____	Toggle
*68A (VDC)	08:_____	Campbell 23X internal battery voltage
A	09:_____	Power supply voltage (VDC)

PLACE IN RUN MODE

Enter *0 on the 23X keypad to place the 23X in the Run mode. The 23X display will show LOG12 to indicate correct operation. If the 23X does not display LOG12, call ARS immediately for instructions.

4.1.2.3 Timing

CHECK TIMING
(if applicable)

Document whether or not your watch is synchronized with NIST time by marking **YES** or **NO**.

For sites that operate in cycled mode, record the exact time the transmitter light turns on and off, and the exact time the receiver toggle light changes state in the appropriate spaces. For sites that operate on continuous mode, check to see if the toggle light changes state every minute.

For cycled mode, the transmissometer system operates according to the timed sequence described below. It is possible to check the system timing of both the receiver and the transmitter from the receiver station.

<u>HR:MI:SEC</u>	<u>ACTION</u>
09:00:00	Transmitter turns ON
09:03:00	Receiver begins 10-minute average reading (cannot be observed)
09:13:20	Receiver finishes reading, toggle changes, front panel display updates
09:16:00	Transmitter turns OFF
10:00:00	Transmitter turns ON

The sequence repeats hourly.

The system clocks will drift over time. For correct operation, it is critical that the receiver take its reading well-centered within the lamp-on interval.

RECEIVER READING

Record the updated receiver reading of the “C” and “B” positions of the A1 switch. Document whether the toggle is on or off.

ACTUAL CONDITIONS

Document whether the b_{ext} reading represents your estimate of visual range.

RESET COMPUTER

Document whether or not a computer reset was performed during this site visit.

The computer is reset by turning the power switch **OFF** for at least one second and returning it **ON** (see Section 4.2.1). If the computer is reset, the timing must also be reset.

RESET TIME Document whether or not a timing reset was performed during this site visit. A timing reset must be done each time the computer is reset.

4.1.2.4 Air Temperature/Relative Humidity

VERIFY AT/RH READINGS Document whether the AT/RH readings on the datalogger represent actual conditions.

ASPIRATION FAN Document whether the AT/RH aspiration fan is operating. If it is not operating, call ARS for a replacement.

INLET SCREEN If the unit has an inlet screen, document whether it is clean. If dirty, remove it and brush off any accumulated debris..

4.1.2.5 Special Servicing

CHANGE LAMP Document whether or not the lamp was changed at the transmitter station. If the lamp was changed at the transmitter, the receiver computer calibration number (cal #) must also be changed.

CHANGE CALIBRATION NUMBER Document whether or not the calibration number (cal #) was changed and record the new number.

GENERAL COMMENTS / SUPPLIES NEEDED Space for additional comments is provided at the bottom of the log sheet. This space should also be used to request additional servicing supplies.

4.2 INTERMITTENT SERVICING AND MAINTENANCE

This section presents detailed procedures to accomplish the following intermittent servicing and maintenance tasks:

- Checking and resetting system timing
- Transmitter lamp changes
- AC power system servicing

The procedures described in the following subsections refer to specific instrument components. Detailed schematic diagrams and instrument component descriptions are provided for reference in TI 4110-3350, *Transmissometer Monitoring System Diagrams and Component Descriptions*.

4.2.1 Checking and Resetting System Timing

Resetting system timing is only necessary if the transmissometer system is operating in a cycled mode (20-min., 1-hr., 2-hrs., or 4-hrs.). If the transmissometer system operates in continuous mode, the system timing does not need to be checked and reset. When resetting the timing at both stations, reset the transmitter timing first.

CHECK TRANSMITTER
TIMING

Set your digital watch by calling the National Institute of Standards and Technology in Boulder, Colorado (1-303/499-4111), or logging onto <http://www.time.gov>.

The transmitter beam can be observed at the receiver station with the unaided eye or through the telescope. At the transmitter, the light can be seen at the back of the instrument through the lamp housing. Do not look into the transmitter telescope.

Observe the time the transmitter light turns either on or off. Document this on the appropriate log sheet.

CHECK RECEIVER
TIMING

Observe the receiver computer toggle light and record the time it changes state (i.e., on to off, or off to on).

TIMING SEQUENCE

The transmissometer system should follow a timing sequence:

<u>HR:MI:SEC</u>	<u>ACTION</u>
XX:00:00	Transmitter lamp turns ON
XX:03:00	Receiver begins 10-minute average reading (cannot be observed)
XX:13:20	Receiver finishes reading, toggle changes, front panel display updates
XX:16:00	Transmitter turns OFF
XX:00:00	Sequence repeats hourly

TIMING TOLERANCE

IMPORTANT: When there is less than 45 seconds or more than 5 minutes between the toggle update and the lamp turnoff, the timing system needs resetting.

RESET TRANSMITTER
TIMING

To reset transmitter timing:

- Set your digital watch to NIST time (see above) before going to the station.
- Arrive at the transmitter station at least five minutes before the hour.
- Precisely at the top of the hour, hold both the **S** (select) and **M** (mode) keys down until a prompt is received. Use the RST menu selection. With RST displayed, press the **S** button twice to start the cycle clock and an integration at this point and time. (See TI 4110-3350, *Transmissometer System Diagrams and Component Descriptions*).
- The transmitter lamp will turn on.
- Verify that the transmitter (lamp) turns off at 16 minutes past the hour.
- Document the time reset on the transmitter log sheet.

RESET RECEIVER TIMING

To set receiver timing:

- Set your digital watch to NIST time (see above) before going to the station.
- Arrive at the receiver station at least five minutes before the hour.
- At 2 minutes and 30 seconds after the hour (or 2 minutes and 30 seconds after the transmitter light turns on), turn the computer power switch **OFF** and leave the switch in the OFF position for at least one second, and flip the switch back ON. For switch locations, see TI 4110-3350, *Transmissometer System Diagrams and Component Descriptions*.
- At precisely 3 minutes after the hour (or 3 minutes after the transmitter light turns on), hold the time reset switch in the UP position for ½ second. Let it return to its down or ON position.
- Verify that the reading updates and the toggle light changes state at approximately 13 minutes and 20 seconds after the hour.
- Document the time reset on the receiver log sheet.

4.2.2 Transmitter Lamp Changes

LAMP REMOVAL

IMPORTANT: Lamps are removed by loosening the knurled knob set screw located on the top of the transmitter lamp housing unit and then pull them out; do not loosen the screws on the lamp housing plate. Since the lamp filaments are fragile, especially after use, the lamps should be removed and inserted very carefully and gently.

Refer to TI 4110-3350, *Transmissometer System Diagrams and Component Descriptions*, for the location of the items described.

To remove transmitter lamps:

- Take the new lamp out of the lamp case, handling it by the holder only. Do not touch the glass with your fingers.
- Clean the lamp with alcohol and Kimwipes. Carefully set the lamp aside in a safe place.
- Turn the transmitter power off at the power supply or at the connector on the backside of the transmitter.

LAMP REMOVAL (continued)

- Remove the old lamp by loosening the knurled knob set screw on top of the transmitter above the lamp. The lamp can then be pulled out of the lamp holder. Some lamps may have to be removed by gently prying around the lamp holder with the aid of a small flat-blade screwdriver.
- Let the old lamp cool and place it in the lamp case. Mark the date and time the lamp was removed on the transmitter operator log sheet.

Note: If the transmissometer system is operating in a cycled mode (20-min., 1-hr., 2-hrs., or 4-hrs.):

- Arrive at the transmitter station 10-15 minutes before the top of the hour to allow time for removing the old lamp and for cleaning the new lamp before insertion.
- If the transmitter is in the ON mode and a reading is being taken, do not disrupt the reading – wait until the transmitter has turned off.

LAMP INSERTION

To insert a new lamp:

- Insert the cleaned replacement lamp into the lamp socket and tighten the knurled knob set screw. Be very careful to align the lamp contact pins with the holder sockets, then firmly push the lamp all the way in and tighten the screw. The lamp must be fully seated into the socket for proper instrument operation.
- **IMPORTANT:** the lamp will not turn on unless proper contact is made.
- Return power to the transmitter by turning the power on at the power supply, or reconnect the power cable at the transmitter if the system is run in continuous mode.
- If the transmissometer system is operating in a cycled mode, reset the timing at the top of the hour (see Section 4.2.1).
- Verify that the lamp comes on.
- Document the lamp change on the operator log sheet.

CALIBRATION SETTING Each lamp outputs a slightly different amount of light, requiring a new calibration number setting on the receiver computer with each lamp replacement. Each lamp has been pre-calibrated to determine the lamp-specific calibration number. ARS will call the site operator to request a lam change and will provide the correct calibration number for each new lamp. Set the calibration number on the receiver computer using the thumb-wheel switches labeled “CAL”.

POST-CALIBRATIONS Lamps removed from service will be post-calibrated at ARS after annual site visits. Extra care should be taken in handling and transporting these used lamps because the filaments become very brittle and fragile with use.

4.2.3 AC Power System Servicing

SURGE PROTECTORS Visually check the status of the surge protector indicator lights. Two versions of Northern Technologies’ surge protectors protect instruments from potentially-damaging power surges. One model has two system warning lights, the other has three lights. The lights indicate the surge operating condition of the protector as described below:

Green Light: The surge protector is in good operating condition.

Yellow Light: The surge protector has sustained partial damage as the result of a power surge, but is still capable of providing protection.

Red Light: The surge protector has sustained a massive power surge and is no longer capable of providing protection.

If the red light on either model surge protector is lit, call ARS for a replacement unit.

POWER SUPPLY A 10-amp power supply is used at the transmitter when AC power is available. A 5-amp power supply is used at the receiver when AC power is available. Check to see if the power supply indicator light is on when the power supply is turned on.

WIRING AND CONNECTORS Periodically check wiring for damage and connectors for tightness.

4.3 PROBLEMS OR QUESTIONS

Call ARS immediately if any problems occur or if any questions arise. Many problems can be resolved through telephone consultation.

ARS may be reached at the following telephone numbers:

Telephone: 970/484-7941
Fax: 970/484-3423

Detailed troubleshooting procedures to assist with telephone-directed problem resolution are presented in TI 4110-3305, *Troubleshooting and Emergency Maintenance Procedures for Optec LPV-3 Transmissometer Systems (IMPROVE Protocol)*.

4.4 HANDLING LOG SHEETS

The site operator must complete a transmissometer operator log sheet for each transmitter and receiver site visit. Upon returning to the office, fax the completed sheets to ARS (Fax 970/484-3423) and mail the original log sheets to ARS:

Air Resource Specialists, Inc.
Attn: Optical Data Analyst
1901 Sharp Point Drive, Suite E
Fort Collins, CO 80525

Any additional information or other pertinent supplemental documentation that the operator deems important can also be included with the log sheets.

APPENDIX A

NPS Visibility Monitoring Network Optec LPV Transmissometer Operator's Guide



OPTEC LPV TRANSMISSOMETER OPERATOR'S GUIDE

OVERVIEW

The Optec LPV transmissometer system is available in two models, the LPV-2 and the LPV-3. The instrument continuously and directly measures the light transmission properties of the atmosphere along a selected sight path.

The instrument has two primary components: a light source (transmitter) and a light detector (receiver). Depending on the expected range of visual air quality, the components are generally placed from 0.5 to 10 kilometers apart.

The transmitter emits a uniform, chopped, incandescent light beam of constant intensity at regular intervals, and can operate in either a continuous or cycled mode. In the continuous mode, the transmitter projects the chopped signal continuously. In

the cycled mode, the transmitter is programmed on at precise intervals and stays on for selected durations.

The receiver computer locks onto the transmitter light's chopped frequency and separates the transmitter light from ambient lighting. The computer compares the measured transmitter light with the known (calibrated) transmitter light to calculate the transmission of the intervening atmosphere.

The LPV-2 and LPV-3 models differ with the transmitter; the receiver unit is the same. The LPV-2 transmitter includes a control box that controls the lamp functions, while the LPV-3 controls are internal, and accessed via a digital display on the telescope.

Air Resource Specialists, Inc.
1901 Sharp Point Drive, Suite E
Fort Collins, CO 80525
(970) 484-7941

TRANSMITTER

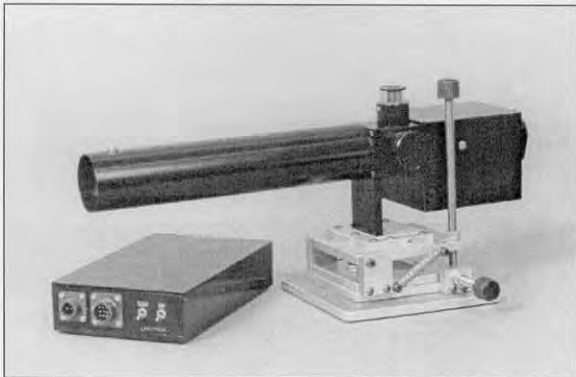

LPV-2 transmitter telescope and control box
(the LPV-3 model does not have a control box)

Introduction

For correct operation, the transmitter must have the proper:

- Alignment
- Timing
- Viewing mirror position
- Window and optical cleanliness
- Lamp regulation
- Power supply

Servicing Frequency

Both the transmitter and receiver stations should be visited weekly. The transmitter should be visited first. Correct operation of the entire system should be verified shortly thereafter at the receiver. Schedule your servicing visit to arrive at the transmitter shelter 10 minutes before the hour. Log sheets must be completed during each site visit.

Regular Maintenance

The primary transmitter servicing tasks are listed below. For detailed descriptions of these tasks and log sheet entries, consult the *Site Operator's Manual for Transmissometer Monitoring Systems*.

1. **Initial Inspection.** Prior to servicing the transmitter, note the general condition of the system and check the telescope alignment and the window and optical cleanliness.
2. **Alignment.** On the log sheet, document the initial position of the receiver shelter window with respect to the reticle circle with a "+". Correct the alignment and note the new position on the log sheet. Return the viewing mirror to the proper position.

3. **Timing.** Verify that the lamp turns on at the top of the hour and stays on for the full 16 minutes. This can also be verified at the receiver.
4. **Clean Window.** Clean the window at every site visit. Remove the pane and clean it thoroughly with alcohol and Kimwipes. Visually inspect the telescope objective lens. If the objective lens is dusty, brush lightly with the photographic brush provided. If any smudges or other obstructions exist on the lens, call ARS. **Do not** clean the objective lens with alcohol. **Do not** use canned air on the window or lens. Re-check the alignment after cleaning the window.
5. **Lamp Check LED (LPV-2 only).** While the transmitter light is on under automatic control, determine the status of the lamp check LED on the side of the control box. The red LED light should remain off. If the LED is on, call ARS. Do not check the LED light with the test switch.

6. **Lamp Check Status. (LPV-3 only).** Note any error code displayed on the telescope:

- ER=1 Supply voltage is less than 10.6 volts.
- ER=2 Maximum safe power to the lamp has been exceeded.
- ER=3 No zero cross signal detected. Lamp or chopper failure.
- ER=4 Real Time Chip has lost power and needs to be initialized.
- ER=5 Temperature of circuit board has exceeded 45°C.

7. **Power Supply Inspection.**

- At sites with line power, check all surge protector indicator lights to determine if a surge has occurred. If indicator lights are red, call ARS.
- At sites with lead-acid batteries, visually check the fluid level in the batteries and fill as needed with distilled water. Battery voltage measurements need only be done at the transmitter upon direction of ARS. Clean and inspect the condition of the solar panels.

8. **Final Check.** Verify proper alignment, then return the viewing mirror to the proper position. The knob should be turned fully counter-clockwise. No image should be visible in the eyepiece.
9. **Log Sheet.** Check that the log sheet is fully completed. The yellow copy remains in the shelter; mail or fax the original to ARS.

RECEIVER

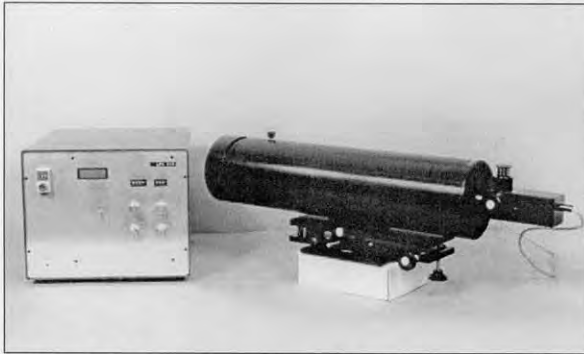

LPV-2 and LPV-3 receiver telescope and computer.

Introduction

For correct operation, the receiver must have the proper:

- Alignment
- Timing
- Viewing mirror position
- Window and optical cleanliness
- Switch settings
- Power supply

Servicing Frequency

Both the transmitter and receiver stations should be visited weekly. The transmitter should be visited first. Correct operation of the entire system should be verified shortly thereafter at the receiver. Schedule your servicing visit to arrive at the transmitter shelter 10 minutes before the hour. Log sheets must be completed during each site visit.

Regular Maintenance

The primary receiver servicing tasks are listed below. For detailed descriptions of these tasks and log sheet entries, consult the *Site Operator's Manual for Transmissometer Monitoring Systems*.

1. **Initial Inspection.** Prior to servicing the receiver, note the general condition of the system and check the telescope alignment, the window and optical cleanliness, and the displayed reading. Convert the displayed reading to visual range by turning the A1 switch from C to B, and determine if the reading agrees with the actual conditions (refer to the orange transmissometer reading card). Make sure that the A1 switch is left in the C position after the check.
2. **Alignment.** On the log sheet, document the initial position of the transmitter light source with respect to the reticle circle with a "+". Correct the alignment and note the new position on the log sheet. Return the viewing mirror to the proper position.

3. **Timing.** All times should be synchronized with the National Institute of Standards and Technology (NIST) time. You can synchronize your digital watch to NIST time by calling the NIST recording at 1/303-499-7111 or logging onto <http://www.time.gov>. The system timing is as follows:

HR	MI	SE	Action
XX	00	00	Transmitter light on
XX	03	00	Receiver starts reading
XX	13	20	Receiver finished reading, toggle changes state, and new reading is displayed
XX	16	00	Transmitter light off

4. **Clean Window.** Clean the window at every site visit. Remove the pane and clean it thoroughly with alcohol and Kimwipes. Visually inspect the telescope objective lens. If the objective lens is dusty, brush lightly with the photographic brush provided. If any smudges or other obstructions exist on the lens, call ARS. Do not clean the objective lens with alcohol. Do not use canned air on the window or lens. Re-check the alignment after cleaning the window.
5. **Power Supply Inspection.**
 - At sites with line power, check all surge protector indicator lights to determine if a surge has occurred. If indicator lights are red, call ARS.
 - At sites with lead-acid batteries, visually check the fluid level in the batteries and fill as needed with distilled water. Battery voltage measurements need only be done at the transmitter upon direction of ARS. Clean and inspect the condition of the solar panels.
6. **Final Check.** Verify proper alignment, then return the viewing mirror to the proper position. The knob should be turned fully counter-clockwise. No image should be visible in the eyepiece.
7. **Log Sheet.** Check that the log sheet is fully completed. The yellow copy remains in the shelter; mail or fax the original to ARS.

SPECIAL MAINTENANCE

Special maintenance tasks are discussed in detail in the *Site Operator's Manual for Transmissometer Monitoring Systems*. Call ARS before performing special maintenance.

Timing Reset

When the system timing is correct, the receiver takes a 10-minute averaged reading centered within the 16-minute transmitter lamp-on time. If the receiver toggle light updates more than 5 minutes before the lamp turns off, or less than a minute before the lamp turns off, the system timing needs to be reset.

1. **Transmitter Timing (LPV-2 only).** Remove the control box cover. With the power switch on, push the small reset button at the top of the hour. The light should come on and stay on for 16 minutes.
2. **Transmitter Timing (LPV-3 only).** Before the top of the hour, hold the M (mode) button down until the STOP prompt is received. Press the S(select) button for Y(yes). Press the M button until RST is displayed. With RST displayed, at the top of the hour, press the S button twice to start the cycle clock and an integration. Then press the M button to display RUN, Press the S button to start the transmitter. Other menus that may appear on the display are:

INTG
CYCL
TEST
LAMP
TIME
RST
RUN

3. **Receiver Timing.** Turn the computer off, then on to clear the system computer. The display should go to zeros. At three minutes after the hour (or three minutes after the transmitter light comes on), push the "reset clock" switch up momentarily, then release. At approximately 13 minutes and 20 seconds after the hour, the reading will update and the toggle light should come on.
4. **Setting Your Watch.** You can synchronize your digital watch to National Institute of Standards and Technology (NIST) time by calling the NIST recording at 1/303-499-7111 or logging onto <http://www.time.gov>.
5. **Call ARS.** Notify ARS of the exact time of the timing reset by telephone and note the timing reset on the log sheet. If you are unsure of the procedure, call ARS for direction.

Lamp Changes

Prior to the scheduled lamp change date, ARS will provide the site operator with the next lamp number and its associated calibration number. Lamp changes should be done when visibility conditions are stable. Both the transmitter and receiver must be visited within as short a time as possible. Use extreme care when removing and storing used lamps. The used lamps are required for post-calibration for the system. Label the lamps with ON/OFF dates and times and record lamp changes on the log sheets.

Things to Avoid

1. **Lamp Changes.** The lamp is held into the rear of the transmitter by a friction fit and is removed by pulling it straight out of the transmitter body. On LPV-3 systems, loosen the setscrew at the top before pulling on the lamp. Do not loosen any screws on the lamp alignment plate or the system will need re-calibration.
2. **Transmitter Focus.** Do not change the focus of the transmitter telescope or the system will need re-calibration.
3. **Radio Transmission.** Do not transmit with hand-held radios within 10 feet of either transmissometer component, or the timing may need to be reset.
4. **Computer Resets.** Avoid unnecessary computer resets (OFF/ON) as the timing may be disrupted.

Troubleshooting

The majority of transmissometer problems are caused by:

- Misalignment
- Incorrect system timing
- Incorrect viewing mirror position
- Inadequate power

Check for these potential causes and refer to the *Site Operator's Manual for Transmissometer Monitoring Systems* before calling ARS.

Contact ARS

Please contact us if any questions or problems arise:

Carter Blandford, Karen Rosener, or Jared Merk
Air Resource Specialists, Inc.
1901 Sharp Point Drive, Suite E
Fort Collins, Colorado 80525
970/484-7941

APPENDIX B

Example Completed LPV-3
Transmissometer Transmitter
Log Sheet



LPV-3 TRANSMISSOMETER OPERATOR LOG SHEET
TRANSMITTER STATION

Date 3/15/2005 Local Time 13:40 Operator(s) J. Mark Location ROMO
Weather Conditions Overcast warm light breeze
Visibility Conditions: Excellent Good Fair Poor Estimated visual range 60 miles
Details Humid haze

INITIAL CONDITION

1. Instrument Number LPV- 14 Display Screen LPV3 Lamp Number 539

2. Mark the INITIAL location of receiver shelter window with a "+" in the circle below.

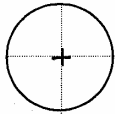

Comments On target

IMPORTANT: RETURN FLIP MIRROR TO PROPER (ON) POSITION.

3. Initial Window Cleanliness: Good Moderate Poor
Comment _____

4. Does the instrument appear to be working properly? Yes No Details: _____

SERVICING

1. Was the alignment corrected? Yes No If Yes, time aligned _____

2. Window Cleaned? Yes No If Yes, time cleaned 13:42

3. Lens Inspected? Yes No If Yes, lens cleaned? Yes No

IMPORTANT: USE ONLY THE BLOWER BRUSH TO CLEAN THE TELESCOPE LENS.

TIMING

1. Is your watch synchronized with NIST time? (telephone 303-499-7111 or <http://www.time.gov>) Yes No

2. Transmitter Light ON, Exact Time, (HR:MIN:SEC) 14 : 01 : 38

3. Transmitter Light OFF, Exact Time, (HR:MIN:SEC) 14 : 17 : 38

4. Timing Reset? Yes No If Yes, time transmitter was reset _____

IMPORTANT: THE TRANSMITTER TIMING MUST ONLY BE RESET AT EXACTLY THE TOP OF THE HOUR!

SPECIAL SERVICING (upon ARS instruction)

1. Lamp Changed? Yes No
Time lamp changed _____ New lamp number _____

IMPORTANT: IF LAMP IS CHANGED, RECEIVER COMPUTER CALIBRATION (CAL) NUMBER MUST ALSO BE CHANGED.

2. Alignment corrected after lamp change? Yes No

GENERAL COMMENTS/SUPPLIES NEEDED

Send the white copy of this form to:
(keep the yellow copy on site)

Air Resource Specialists, Inc.
1901 Sharp Point Drive, Suite E
Fort Collins, CO 80525

Telephone: 1-800-344-5423
Fax: 1-970-484-3423

APPENDIX C

Example Completed LPV-3
Transmissometer Receiver
Log Sheet



**LPV-3 TRANSMISSOMETER OPERATOR LOG SHEET
RECEIVER STATION**

Date 3/15/2005 Local Time 15:15 Operator(s) J. Mark Location ROMO
Weather Conditions Overcast breezy
Visibility Conditions: Excellent Good Fair Poor Estimated visual range 280 miles
Details Excellent according to transmissometer

INITIAL CONDITION

- Instrument Number LPV-14 Local Time 15:15 Toggle: On Off
- Settings: Gain .500 Cal 736 Path 3.91 A1 C A2 SD Integ 10 Cycle 1H
- Switch A1 readings: B (b_{ext} reading) .013 C (raw reading) 698 VR (visual range km) 300
- Does the b_{ext} reading represent actual conditions? Yes No Comment _____

IMPORTANT: RETURN A1 SWITCH TO "C" (CYCLED MODE) OR "B" (CONTINUOUS MODE) AFTER CHECK.

- Mark the INITIAL location of transmitter light source with a "+" in the circle below.

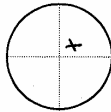

Comments Target is above and to right of center.

IMPORTANT: RETURN FLIP MIRROR TO PROPER (ON) POSITION.

- Initial Window Cleanliness: Good Moderate Poor Comment Almost no dust.
- Does the instrument appear to be working properly? Yes No Details: _____
- Are all cables and connectors secure? Yes No Details: _____

SERVICING

- Was the alignment corrected? Yes No If Yes, time aligned 15:17
- Window Cleaned? Yes No If Yes, time cleaned 15:18
- Lens Inspected? Yes No If Yes, lens cleaned? Yes No
- Is the junction box voltage lamp illuminated green? Yes No
- Is the datalogger date and time correct? Yes No Comment _____

IMPORTANT: USE ONLY THE BLOWER BRUSH TO CLEAN THE TELESCOPE LENS.

- Record datalogger readings: *61A 01: 20.5 Ambient temperature (°C) A 05: 998 Toggle
A 02: 30.2 Relative humidity (%) *68A 08: 13.8 Internal battery voltage
A 03: 35.1 Extinction (1/km) A 09: 13.73 Power supply voltage
A 04: 698 Raw reading (counts)

IMPORTANT: RETURN THE DATALOGGER TO RUN MODE (*0).

TIMING

- Is your watch synchronized with NIST time? (telephone 303-499-7111 or <http://www.time.gov>) Yes No
- Transmitter Light ON, Exact Time, (HR:MIN:SEC) 16 : 01 : 38
- Receiver Toggle Update, Exact Time, (HR:MIN:SEC) 16 : 16 : 38
- Transmitter Light OFF, Exact Time, (HR:MIN:SEC) 16 : 17 : 38

- Updated Receiver Reading: C(raw reading) 704 B(b_{ext} reading) .013 Toggle: On Off

IMPORTANT: RETURN A1 SWITCH TO "C" (CYCLED MODE) OR "B" (CONTINUOUS MODE) AFTER CHECK.

Does the updated b_{ext} reading represent your estimate of visual range? Yes No

Comment _____

- Computer Timing Reset? Yes No If Yes, time reset _____

IMPORTANT: FOR PROPER RECEIVER COMPUTER TIMING RESET PROCEDURES, CALL ARS.

AIR TEMPERATURE / RELATIVE HUMIDITY

- Do the datalogger AT/RH readings represent actual conditions? Yes No Comment _____
- Is the AT/RH aspiration fan operating? Yes No Comment _____
- Is the inlet screen clean? Yes No Comment _____

SPECIAL SERVICING (upon ARS instruction)

- Lamp changed at transmitter station? Yes No If yes, new lamp number _____

IMPORTANT: IF LAMP IS CHANGED, RECEIVER COMPUTER CALIBRATION (CAL) NUMBER MUST ALSO BE CHANGED.

- Receiver computer CAL number changed? Yes No If Yes, new CAL number entered: _____

GENERAL COMMENTS/SUPPLIES NEEDED

Send the white copy of this form to:
(keep the yellow copy on site)

Air Resource Specialists, Inc.
1901 Sharp Point Drive, Suite E
Fort Collins, CO 80525

Telephone: 1-800-344-5423
Fax: 1-970-484-3423

QUALITY ASSURANCE/QUALITY CONTROL DOCUMENTATION SERIES	
TITLE	TROUBLESHOOTING AND EMERGENCY MAINTENANCE PROCEDURES FOR OPTEC LPV-2 TRANSMISSOMETER SYSTEMS (IMPROVE PROTOCOL)
TYPE	TECHNICAL INSTRUCTION
NUMBER	4110-3300
DATE	NOVEMBER 1993

AUTHORIZATIONS		
TITLE	NAME	SIGNATURE
ORIGINATOR	J. Carter Blandford	
PROJECT MANAGER	Mark Tigges	
PROGRAM MANAGER	David L. Dietrich	
QA MANAGER	Gloria S. Mercer	
OTHER		

REVISION HISTORY			
REVISION NO.	CHANGE DESCRIPTION	DATE	AUTHORIZATIONS
1.0	Modify figures for connecting components	March 1995	
1.1	Minor text changes	August 1996	
2.0	Delete stripcharts / update log sheets / change to singleboard computer.	November 2004	

TABLE OF CONTENTS

<u>Section</u>	<u>Page</u>
1.0 PURPOSE AND APPLICABILITY	1
2.0 RESPONSIBILITIES	1
2.1 Project Manager	1
2.2 Field Specialist	1
2.3 Data Analyst	2
2.4 Instrument Technician	2
2.5 Site Operator	3
3.0 REQUIRED EQUIPMENT AND MATERIALS	3
4.0 METHODS	6
4.1 General Information	7
4.2 Transmissometer and Support Equipment Troubleshooting	8
4.2.1 Transmitter Troubleshooting	8
4.2.2 Receiver Troubleshooting	14
4.2.3 DCP Troubleshooting	17
4.2.4 Solar Power System Troubleshooting	21
4.2.5 AC Power System Troubleshooting	21

LIST OF FIGURES

<u>Figure</u>	<u>Page</u>
2-1 LPV-2 Transmissometer Operator Log Sheet – Transmitter Station	4
2-2 LPV-2 Transmissometer Operator Log Sheet – Receiver Station	5
4-1 Transmitter Component Diagram	10
4-2 Transmitter Control Box for Location of Fuse	11
4-3 Transmitter Lamp Chamber	12
4-4 Voltmeter Connections for Measuring Lamp Voltage	13
4-5 Receiver Component Diagram	15
4-6 Receiver Computer Cards and Fuse Diagram	16

LIST OF FIGURES (CONTINUED)

<u>Figure</u>		<u>Page</u>
4-7	DCP Cable Connection and Display Diagram	18
4-8	DCP Antenna Component Diagram	19

LIST OF TABLES

<u>Table</u>		<u>Page</u>
4-1	DCP Antenna Alignment for IMPROVE Sites	20

1.0 PURPOSE AND APPLICABILITY

This technical instruction (TI) describes on-site troubleshooting procedures to be followed when a malfunction of the Optec LPV-2 transmissometer system at an IMPROVE Protocol site is suspected. The purpose of on-site troubleshooting is to assure quality data capture and minimize data loss by performing operational checks on transmissometers, data acquisition systems, and support equipment that will either identify the probable source of a system malfunction, or verify proper system operation.

This TI, as referenced from Standard Operating Procedure (SOP) 4110, *Transmissometer Maintenance (IMPROVE Protocol)*, serves as a guideline for:

- Transmitter system operational verification.
- Receiver system operational verification.
- Data collection platform (DCP) and support equipment operational verification.
- Solar power (DC) system operational verification.
- Line power (AC) system operational check.

Due to variations in the site configurations of IMPROVE Protocol sites, portions of this TI may not apply to every transmissometer station.

2.0 RESPONSIBILITIES

2.1 PROJECT MANAGER

The project manager shall:

- Coordinate with the site operator, his/her supervisor, field specialist, and data analyst concerning the schedule and requirements for specific troubleshooting procedures.
- Oversee and review specific troubleshooting procedure documentation completed by the site operator, field specialist, or data analyst for accuracy and completeness.

2.2 FIELD SPECIALIST

The field specialist shall:

- Coordinate with the site operator, his/her supervisor, project manager, and data analyst concerning the schedule and requirements for specific troubleshooting procedures.

- Train the site operator in troubleshooting procedures necessary for on-site resolution of instrument problems.
- Provide technical support to the site operator via telephone to assure identification and resolution of instrument problems.
- Document all technical support provided to the site operator.
- Resolve problems reported by the site operator.

2.3 DATA ANALYST

The data analyst shall:

- Coordinate with the site operator, his/her supervisor, project manager, and field specialist concerning the schedule and requirements for troubleshooting procedures.
- Identify possible instrument malfunctions and contact the site operator to schedule troubleshooting visits.
- Verify that scheduled visits are performed and notify the site operator if he/she fails to make a scheduled visit.
- Provide technical support to the site operator via telephone to identify and resolve instrument problems.
- Document all technical support provided to the site operator.
- Review documentation completed by the site operator for accuracy and completeness.
- File all hard copy site documentation.
- Ship supplies, tools, and replacement instrumentation necessary for instrument problem resolution to the site operator.
- Enter all correspondence with site operators and the results of all performed procedures into the site-specific timeline.

2.4 INSTRUMENT TECHNICIAN

The instrument technician shall provide technical support to the data analyst in identifying and interpreting instrument problems.

2.5 SITE OPERATOR

The site operator shall:

- Coordinate with his/her supervisor, project manager, field specialist, and data analyst concerning the schedule and requirements for specific troubleshooting procedures.
- Perform procedures described in this TI in response to direction provided by the data analyst or field specialist.
- Thoroughly document all troubleshooting procedures on the LPV-2 Transmissometer Operator Log Sheets (see Figures 2-1 and 2-2) and mail and fax the log sheets to the data analyst.
- Report any noted inconsistencies immediately to the data analyst or field specialist.

3.0 REQUIRED EQUIPMENT AND MATERIALS

Equipment required to support troubleshooting includes:

- Keys for shelters and padlocks
- On-site transmissometer receiver tool kit that includes:
 - Medium and small flat-blade screwdriver
 - Medium and small Phillips-head screwdriver
 - Medium adjustable wrench
 - Pliers
 - Battery terminal cleaner
 - Wire cutters
 - Flashlight
 - Wire ties
 - AA batteries (four) for receiver computer
 - Pen or pencil
 - Utility knife
 - Allen wrench set
 - Blower (photographic) brush
 - Signal mirror
 - AC circuit tester
 - Compass
 - Angle indicator



**LPV-2 TRANSMISSOMETER OPERATOR LOG SHEET
TRANSMITTER STATION**

Date _____ Local Time _____ Operator(s) _____ Location _____
Weather Conditions _____
Visibility Conditions: Excellent Good Fair Poor Estimated visual range _____ miles
Details _____

INITIAL CONDITION

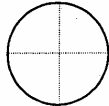
- Instrument Number LPV-_____
- Mark the **INITIAL** location of receiver shelter window with a "+" in the circle below.
 Comments _____
IMPORTANT: Return flip mirror to proper (ON) position.
- Was the alignment corrected? Yes No If Yes, time aligned _____
- Does the instrument appear to be working properly? Yes No
If No, provide details _____

SERVICING

- Initial Window Cleanliness: Good Moderate Poor
Comment _____
- Window Cleaned? Yes No If Yes, time cleaned _____
If No, why not? _____
- Lens Inspected? Yes No If Yes, lens cleaned? Yes No
IMPORTANT: Use only the blower brush to clean the telescope lens.
- Solar Panels Cleaned? Yes No Comment _____
- Battery Voltage (charging) _____ Battery Voltage (analyzing) _____
Battery fluid levels should be checked monthly and filled if low.
- Lamp Check **IMPORTANT: Must be done when lamp is ON under automatic control.**
a) LED (indicator light on side of control box) On Off (If On, telephone ARS)
b) Lamp Voltage Reading (switch voltmeter to 20 VDC range) _____ volts, for lamp number _____
IMPORTANT: Switch voltmeter to "OFF" after taking voltage reading.

TIMING

- Is your watch synchronized with NIST time? (telephone 303-499-7111 or <http://www.time.gov>) Yes No
- Transmitter Light ON, Exact Time, (HR:MIN:SEC) _____:_____:_____
- Transmitter Light OFF, Exact Time, (HR:MIN:SEC) _____:_____:_____
- Timing Reset? Yes No If Yes, time transmitter was reset _____
IMPORTANT: THE TRANSMITTER TIMING MUST ONLY BE RESET AT EXACTLY THE TOP OF THE HOUR!

SPECIAL SERVICING (upon ARS instruction)

- Lamp Changed? Yes No If Yes, old lamp number _____ Old lamp voltage _____
Time lamp changed _____ New lamp number _____ New lamp voltage _____
IMPORTANT: If lamp is changed, receiver computer calibration (CAL) number must also be changed.
- Alignment corrected after lamp change? Yes No

GENERAL COMMENTS/SUPPLIES NEEDED

Send the white copy of this form to:
(keep the yellow copy on site)

Air Resource Specialists, Inc.
1901 Sharp Point Drive, Suite E
Fort Collins, CO 80525

Telephone: 1-800-344-5423
Fax: 1-970-484-3423

Figure 2-1. LPV-2 Transmissometer Operator Log Sheet - Transmitter Station.



**LPV-2 TRANSMISSOMETER OPERATOR LOG SHEET
RECEIVER STATION**

Date _____ Local Time _____ Operator(s) _____ Location _____
Weather Conditions _____
Visibility Conditions: Excellent Good Fair Poor Estimated visual range _____ miles
Details _____

INITIAL CONDITION

1. Instrument Number LPV- _____
 2. Receiver Display Reading _____ Local Time _____ Toggle: On Off
 3. Display readings: A1 switch set to: C (raw reading) _____ B(b_{ext} reading) _____
 4. Does the b_{ext} reading represent actual conditions? Yes No Comment _____
- IMPORTANT: Return A1 switch to "C" position after check.**
5. Settings: Gain _____ Cal _____ Dist _____ A1 _____ A2 _____ Int _____ Cycle _____
 6. Mark the **INITIAL** location of transmitter light source with a "+" in the circle below.



Comments _____

IMPORTANT: Return flip mirror to proper (ON) position.

7. Was the alignment corrected? Yes No If Yes, time aligned _____
8. Does the instrument appear to be working properly? Yes No
If No, provide details _____

SERVICING

1. Initial Window Cleanliness: Good Moderate Poor Comment _____
 2. Window Cleaned? Yes No If Yes, time cleaned _____ If No, why not? _____
 3. Lens Inspected? Yes No If Yes, lens cleaned? Yes No
- IMPORTANT: Use only the blower brush to clean the telescope lens.**
4. Solar Panels Cleaned? Yes No Comment _____
 5. Battery Voltage (charging) _____ Battery Voltage (analyzing) _____
- Battery fluid levels should be checked monthly and filled if low.**

TIMING

1. Is your watch synchronized with NIST time? (telephone 303-499-7111 or <http://www.time.gov>) Yes No
 2. Transmitter Light ON, Exact Time, (HR:MIN:SEC) _____:_____:_____
 3. Receiver Toggle Update, Exact Time, (HR:MIN:SEC) _____:_____:_____
 4. Updated Receiver Reading: C(raw reading) _____ B(b_{ext} reading) _____ Toggle: On Off
- IMPORTANT: Return A1 switch to "C" position after check.**
- Does the updated b_{ext} reading represent your estimate of visual range? Yes No
Comment _____
5. Transmitter Light OFF, Exact Time, (HR:MIN:SEC) _____:_____:_____
 6. Computer Timing Reset? Yes No If Yes, time reset _____
- IMPORTANT: FOR PROPER RECEIVER COMPUTER TIMING RESET PROCEDURES, CALL ARS.**

SPECIAL SERVICING (upon ARS instruction)

1. Lamp Changed at Transmitter Station? Yes No
IMPORTANT: If lamp is changed, receiver computer calibration (CAL) number must also be changed.
2. Receiver computer CAL number changed? Yes No If Yes, new CAL number entered: _____

GENERAL COMMENTS/SUPPLIES NEEDED _____

Send the white copy of this form to:
(keep the yellow copy on site)

Air Resource Specialists, Inc.
1901 Sharp Point Drive, Suite E
Fort Collins, CO 80525

Telephone: 1-800-344-5423
Fax: 1-970-484-3423

Figure 2-2. LPV-2 Transmissometer Operator Log Sheet - Receiver Station.

- On-site transmissometer transmitter tool kit that includes:
 - Small flat-blade screwdriver
 - Pen or pencil
 - Flashlight
 - Blower (photographic) brush
 - Signal mirror
 - AA batteries (four) for the control box

- Battery tester

- Distilled water

- Watch

- Site Operator's Manual for Transmissometer Monitoring Systems

- LPV-2 Transmissometer Operator's Guide

- LPV-2 Transmissometer Operator Log Sheets (transmitter and receiver)

- Tenma digital voltmeters with cables (transmitter and receiver)

- Transmissometer component shipping cases

- Spare fuse kit, including:
 - 1-amp AGC glass fuse for transmissometer receiver computer
 - 5-amp AGC glass fuse for transmissometer transmitter (control box)
 - 20-amp AGC glass fuse for M-16 solar panel regulator (orange style)
 - 3-amp AGC glass fuse for 5-amp power supply (for receiver station with AC line power)
 - 2.5-amp AGC glass fuse for 10-amp power supply (for transmitter station with AC line power)

If any tool(s) and/or equipment necessary to support troubleshooting procedures are not available, please contact ARS at 970/484-7941.

4.0 METHODS

This section includes two (2) major subsections:

4.1 General Information

4.2 Transmissometer and Support Equipment Troubleshooting

4.1 GENERAL INFORMATION

The majority of transmissometer problems are caused by:

- Misalignment.
- Incorrect system timing.
- Incorrect viewing mirror position.
- Inadequate power.

Many times operators can diagnose and solve instrument problems in the field, reducing costly site visits and minimizing data loss. Two good practices to follow in troubleshooting are: 1) start with the simple checks and progress towards the more complicated, and 2) break a system down into individually testable subsystems.

TROUBLESHOOTING

Many transmissometer system problems can be solved by checking items in the following categories:

- Obvious sources:
 - The power is unplugged or not turned on.
 - The flip mirror(s) are not in the correct position (ON).
 - The transmitter, receiver, or both are misaligned.
 - System timing is not synchronized (refer to TI 4110-3100, *Routine Site Operator Maintenance Procedures for LPV-2 Transmissometer Systems (IMPROVE Protocol)*).
 - Incorrect instrument settings.
- Power supply:
 - Battery voltage is not sufficient to run the system.
 - A fuse is blown in the receiver computer or in the transmitter control box.
 - Incorrect polarity exists on power leads.
 - Power connectors are not making good contact (pins).
 - Solar panels are covered with snow or shaded by tree branches.

TROUBLESHOOTING
(continued)

- Connectors:
 - A connector is not plugged in, or is in the wrong input position.
 - A connector is not making good contact.
 - Connector pins or sockets are damaged.
 - The cable/connector is damaged, resulting in a broken wire or electrical short.

BEFORE CALLING FOR
ASSISTANCE

Before reporting problems or requesting assistance in diagnosing an instrument problem, please do the following:

- Check problem areas listed above (obvious sources, power supply, and connectors).
- Follow procedures for troubleshooting the component in question (see following sections).
- Have documentation of your tests available.
- Have a site operator's manual available.

Please call promptly with suspected or observed instrument problems. If the person you need to speak with is not in, ask to be directed to another or leave a message, including your name, location, telephone number, and a brief description of the problem(s) or need(s).

4.2 TRANSMISSOMETER AND SUPPORT EQUIPMENT TROUBLESHOOTING

4.2.1 Transmitter Troubleshooting

INOPERABLE
TRANSMITTER

If the transmitter will not operate, check the following:

- The ON/OFF switch is in the ON position.
- The power cable contacts at the battery are not loose, corroded, or covered with excessive deposits.
- The connectors are firmly tightened at the control box and transmitter.
- The battery voltage is adequate (above 11 VDC).
- The fuse inside the control box is intact.

DAMAGED FUSE IN TRANSMITTER CONTROL BOX

To check the fuse inside the transmitter control box:

- Remove the screws on the top plate of the control box (see Figure 4-1, Transmitter Component Diagram).
- Refer to Figure 4-2, Transmitter Control Box for Location of Fuse.
- Replace damaged fuse with a 5-amp fuse.

COPPER FAILURE

If the lamp turns on and stays on, the problem may be that the chopper motor is not operating or the chopper blade may have fallen off the motor spindle. To determine if the chopper is operating properly, check the following:

- Remove the transmitter lamp housing access top cover (see Figure 4-1, Transmitter Component Diagram).
- Verify that the chopper blade (slotted disk) is still mounted on the motor shaft and is rotating (see Figure 4-3, Transmitter Lamp Chamber).
- If the chopper blade had detached, turn power to the system off and remove the chopper blade from the lamp chamber. Remove the lamp from the transmitter and place it in the lamp storage case. Remove the transmitter telescope and control box and place them in the gray suitcase for shipment to ARS. Telephone ARS for further instructions.

NOTE: It is not possible to determine if the chopper blade is attached by observing the transmitter through the telescope. Due to the speed at which the chopper rotates, both conditions will look the same.

CHOPPER ON/NO LIGHT

If the chopper blade turns on and stays on, but the lamp does not turn on, check the following:

- Is the lamp burned out or has the filament been damaged? Use the voltmeter to measure the lamp voltage as described in TI 4110-3100, *Routine Site Operator Maintenance Procedures for LPV-2 Transmissometer Systems (IMPROVE Protocol)*. Voltmeter connections for measuring lamp voltage are shown in Figure 4-4. If the voltage is greater than 7.0 volts, or if the lamp check LED is ON, the lamp filament is broken and the instrument should be turned off and the lamp should be removed. Telephone ARS for further instructions.

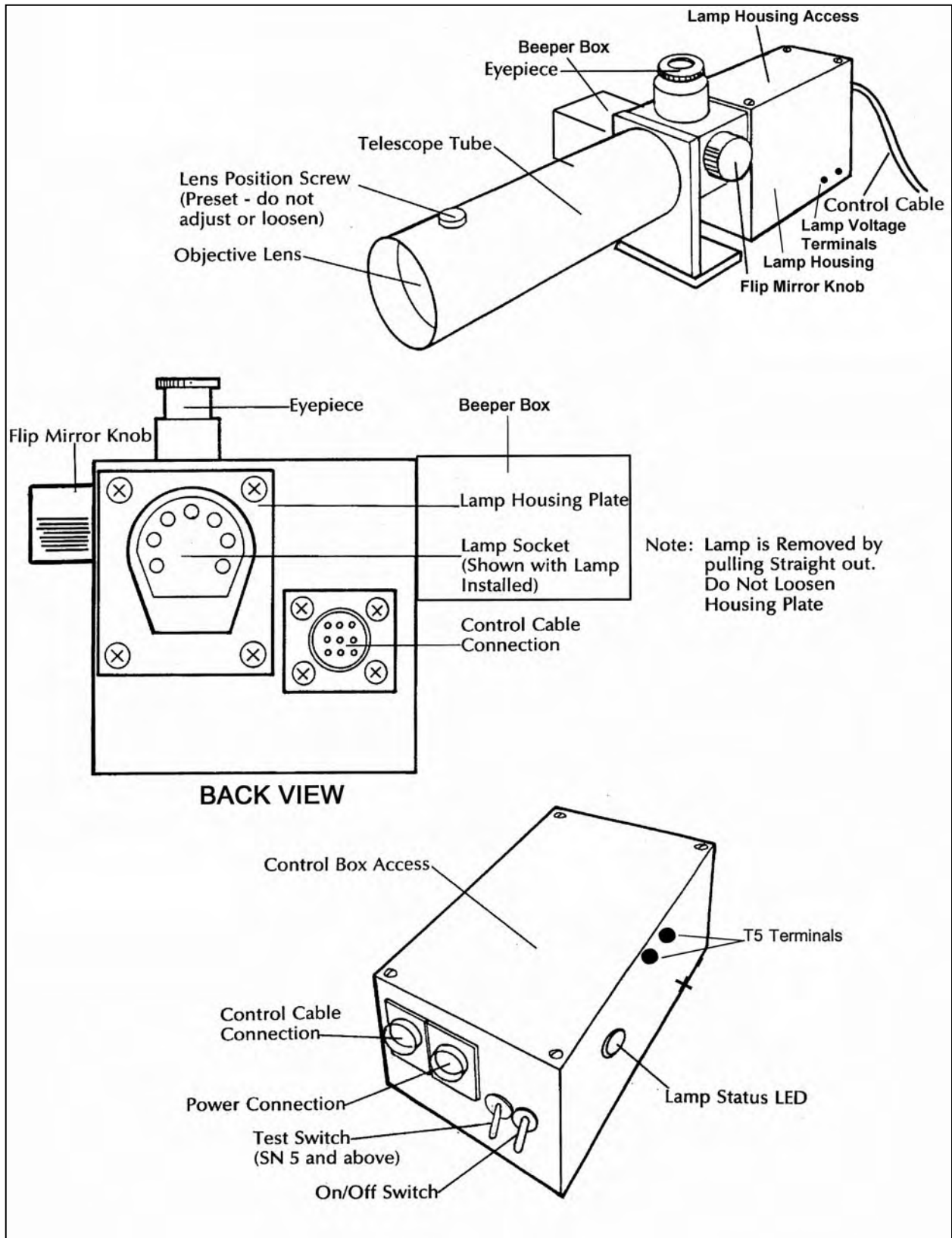

Figure 4-1. Transmitter Component Diagram.

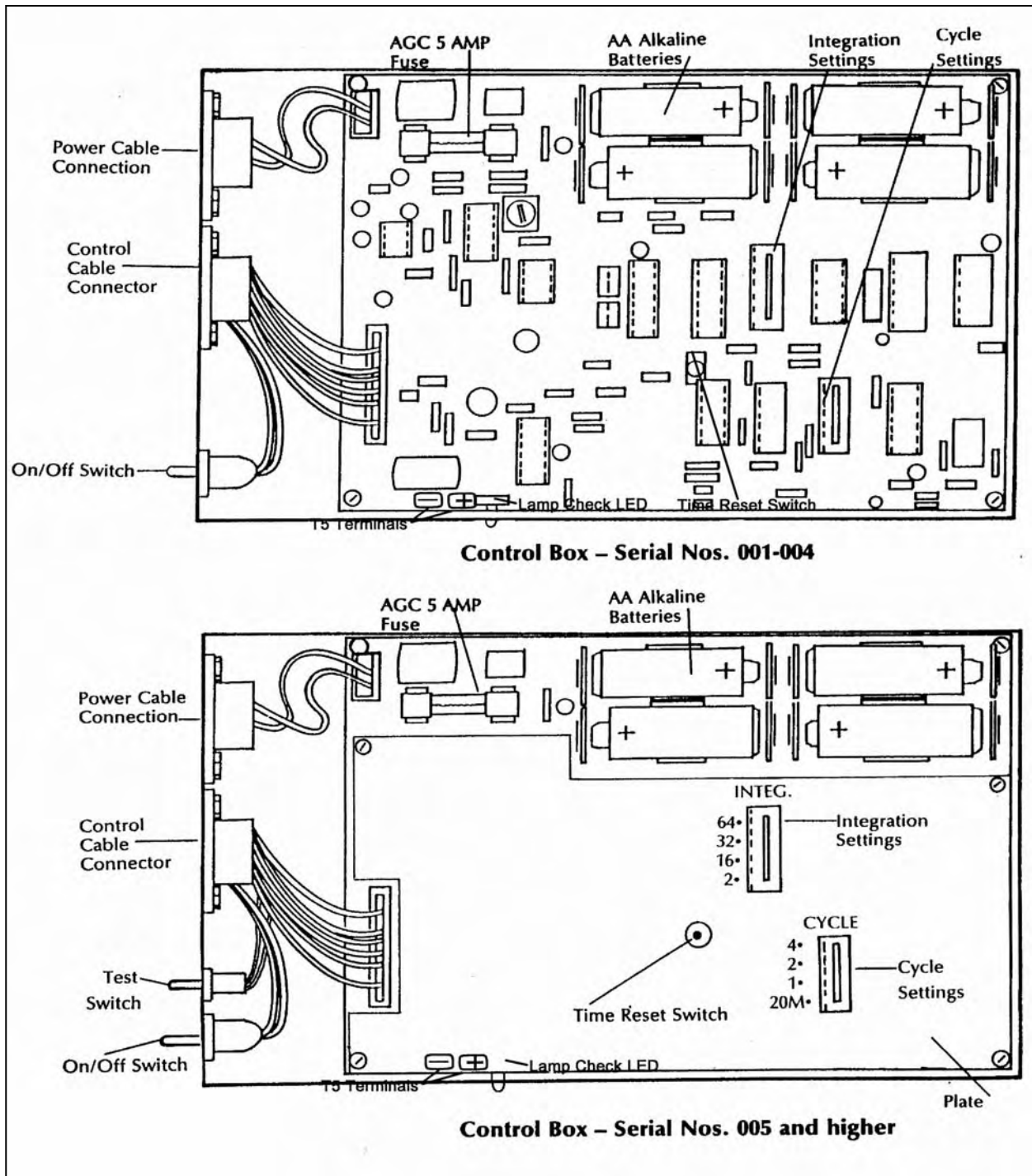

Figure 4-2. Transmitter Control Box for Location of Fuse.

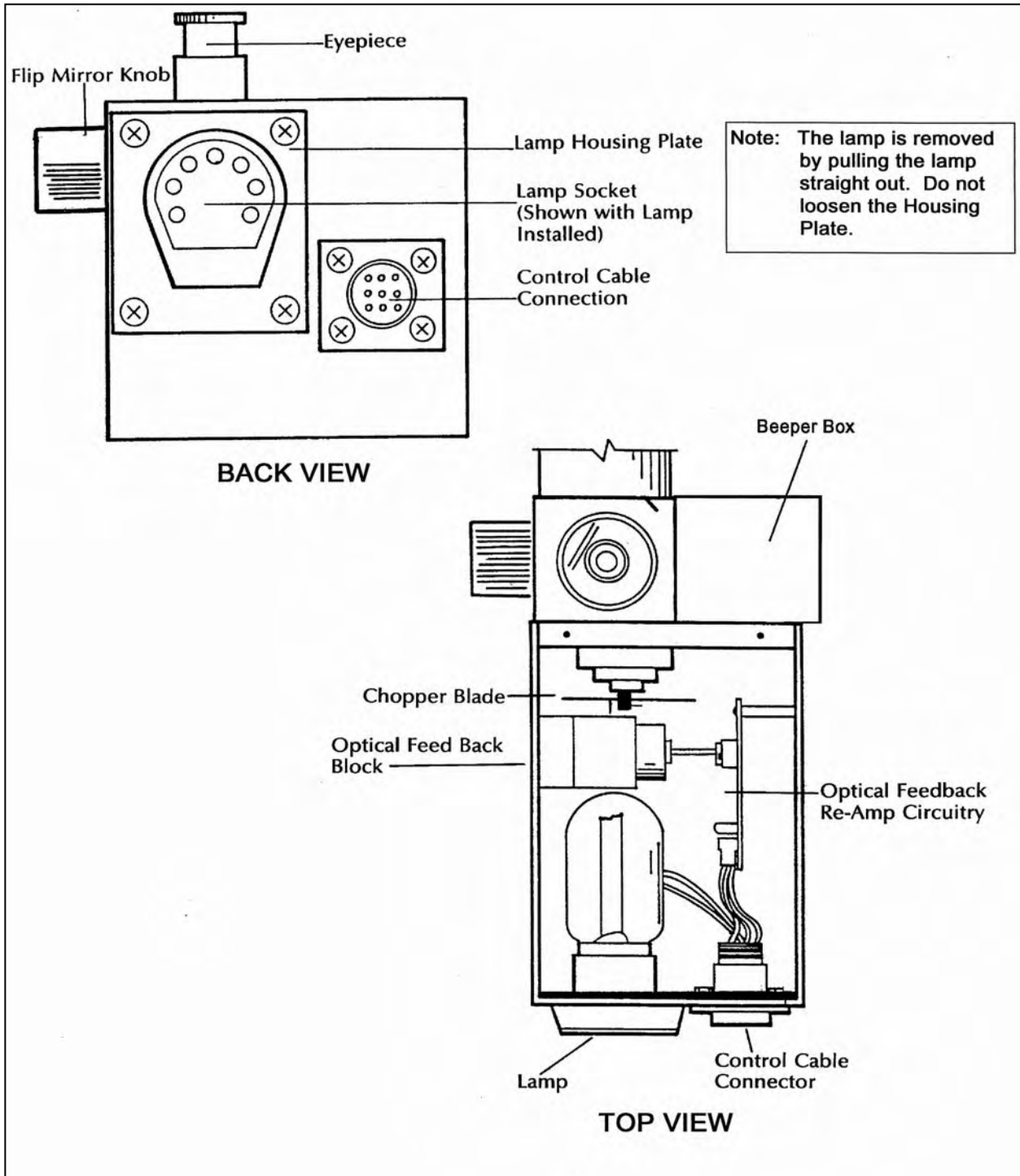

Figure 4-3. Transmitter Lamp Chamber.

CHOPPER ON/NO LIGHT
(continued)

- Is the lamp fully seated and are the lamp pins making good contact in the lamp socket? After removing the transmitter lamp housing top cover (see Figure 4-1, Transmitter Component Diagram), look at the two wires that connect to the lamp socket. If either wire is not fully inserted into the socket, disconnect the power cable at the lamp housing and remove the lamp. From the inside of the lamp housing, press both wires firmly back into the lamp socket. Replace the lamp and retest the transmitter.

TRANSMITTER NOT ON
FOR FULL 16 MINUTES

If the transmitter turns on at the correct time, but does not stay on for the full 16 minutes, check the supply power battery voltage while the transmitter is on. It should remain above 10.5 volts.

4.2.2 Receiver Troubleshooting

POWERING UP

When the receiver computer power is turned on, the computer will perform a series of internal checks and then set the front panel display to “001” (LPV-2, serial #1-4) or “000” (LPV-2, serial # 5 and up). The toggle light should be off. If the display does not go to “000” or “001” upon powering-up, there is a system or component failure; call ARS for further directions. (See Figure 4-5 for a diagram of the receiver computer front panel).

BLANK RECEIVER
DISPLAY

If the receiver display is blank with the power switch ON (especially common after a power surge, lightning strike, or after reinstallation of the receiver computer after the computer has been recently shipped from ARS), check the singleboard computer, front panel board, and ribbon cables in the receiver unit and for a damaged fuse in the receiver (see below).

SINGLEBOARD
COMPUTER, FRONT
PANEL BOARD, AND
RIBBON CONNECTORS

If the receiver display is blank, check the singleboard computer and front panel board to make sure they are firmly attached to the walls of the transmissometer and that the two ribbon connectors are in place and attached.

Remove the four small screws (two on each side) from the sides of the receiver computer and lift the computer top cover off, to check the singleboard computer and front panel board.

DAMAGED FUSE IN
RECEIVER COMPUTER

With the receiver cover removed, check the fuse for damage. Refer to Figure 4-6, Receiver Computer Cards and Fuse Diagram, for location of the fuse. If the fuse is damaged, replace with a 1-amp fuse, replace the receiver computer top cover, and reset the receiver computer and system timing. Refer to TI 4110-3100, *Routine Site Operator Maintenance Procedures for LPV-2 Transmissometer Systems (IMPROVE Protocol)*.

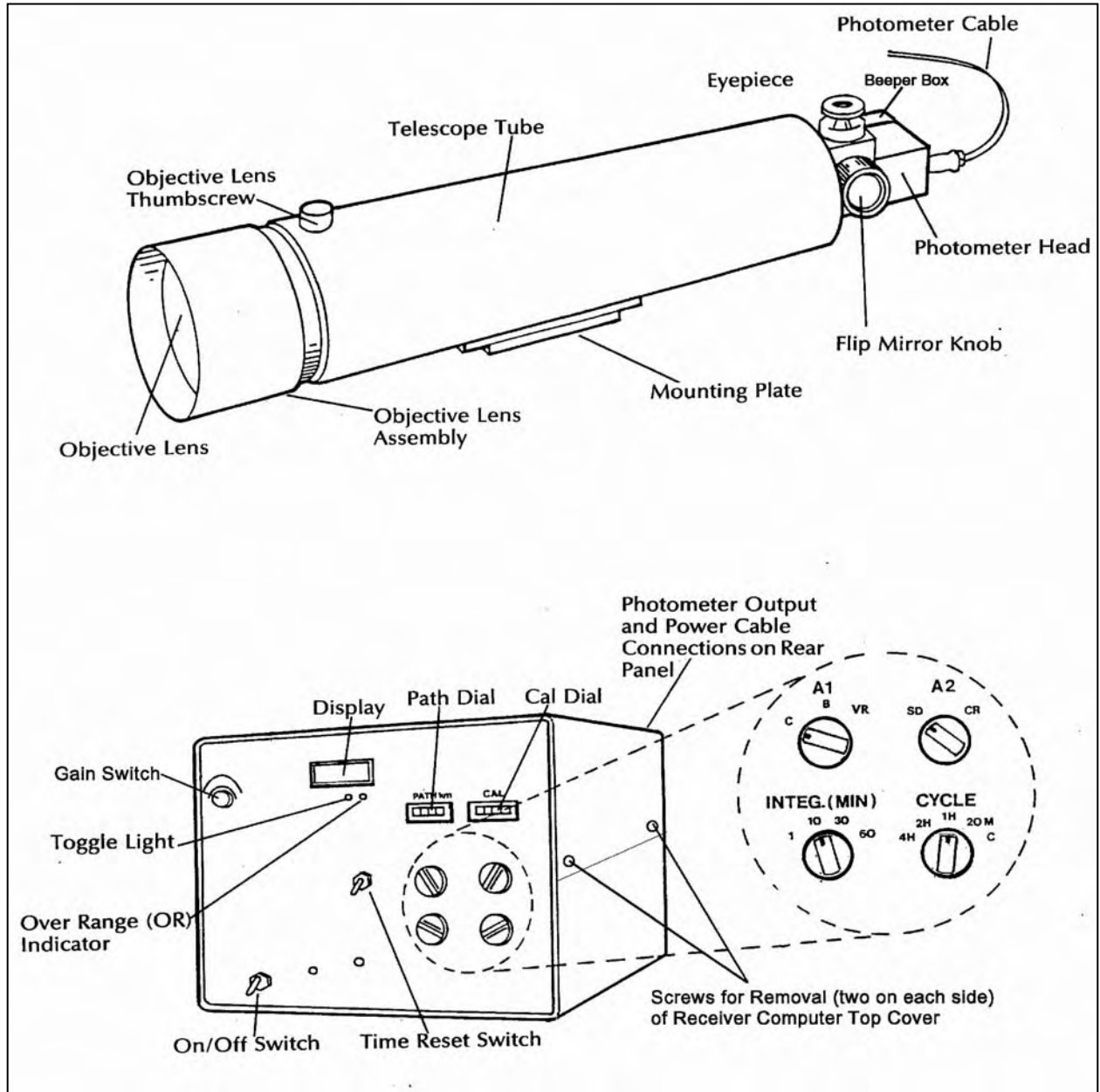

Figure 4-5. Receiver Component Diagram.

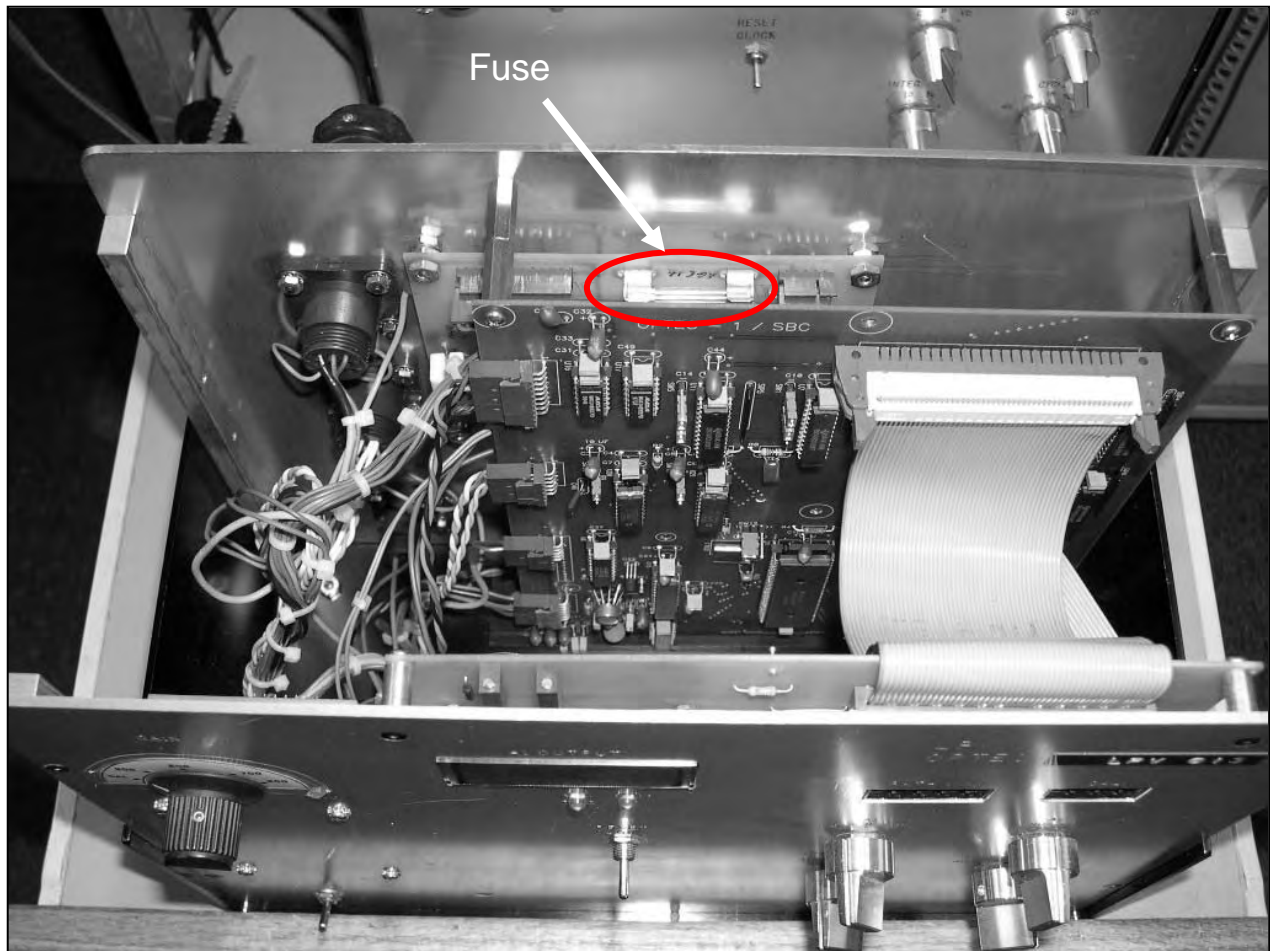

Figure 4-6. Receiver Computer Cards and Fuse Diagram.

TOGGLES DOES NOT UPDATE

If the toggle light does not change state at the correct time:

- Check the system timing (refer to TI 4110-3100, *Routine Site Operator Maintenance Procedures for LPV-2 Transmissometer Systems (IMPROVE Protocol)*).
- The computer may be locked up. When this happens, both the toggle and the reading will stay the same until the computer is reset. Reset the computer by turning the power OFF for one second, and then turn the power switch back ON.
- After resetting the receiver computer, the system timing will need to be reset. (Refer to TI 4110-3110).
- The computer may be malfunctioning. Call ARS for further direction.

VERIFICATION OF RECEIVER COMPUTER INTEGRITY

To determine if the receiver computer reading is being properly relayed to the DCP (model 570 DCP only), the following information and directions can be used.

If a Model 570 DCP is in use at the site, a check may be done to confirm that the DCP data agree with the receiver computer display. Model 570 DCPs have an LED display that allows the user to read the values stored by the DCP for transmission to the GOES satellite. On the back of the DCP, below the LED display, are three push-buttons labeled ROLL-UP, NEXT DIGIT, and DISPLAY. Pressing the DISPLAY button causes the data display to advance through channels 1 – 10 showing the data value stored in each channel. The channel number appears on the far left of the display with the data for that channel appearing at the far right. The DCP channel 1 reading corresponds to the receiver computer display (A1 switch). Record the DCP channel 1 reading along with the date and time of the reading. For the DCP reading to correspond to the receiver computer display reading, both readings must be taken during a time window of approximately 43 minutes beginning at 30 minutes after the top of the hour and ending with the next receiver computer update.

Call ARS to relate the recorded readings to the data analyst or field specialist and to receive further instructions. Return the completed log sheet (white copy) to ARS as soon as possible.

4.2.3 DCP Troubleshooting

Three (3) DCP models (Model 540A-1, Model 540A-2, and Model 570) currently are in use in the IMPROVE transmissometer network. Cable connections and display readings (570 only) may need to be checked if a DCP malfunction is suspected (refer to Figure 4-7, DCP Cable Connection and Display Diagram). If it is determined that the DCP is malfunctioning, it will need to be turned off and returned to ARS for repair. These procedures are provided in TI 4110-3375, *Replacing and Shipping Transmissometer System Components*.

DCP operation and operational parameters used for diagnosing data transmission problems are monitored daily by ARS. Should these parameters indicate a potential DCP problem, you will be contacted by the data analyst or field specialist with a request to perform one or more of the following DCP system checks:

ANTENNA INSPECTION

Visually inspect the antenna to ensure that the driver, reflector, and directional elements (see Figure 4-8, DCP Antenna Component Diagram) are securely attached to their holders. The elements screw into the holders and should be hand-tightened so they are firmly seated against the holder.

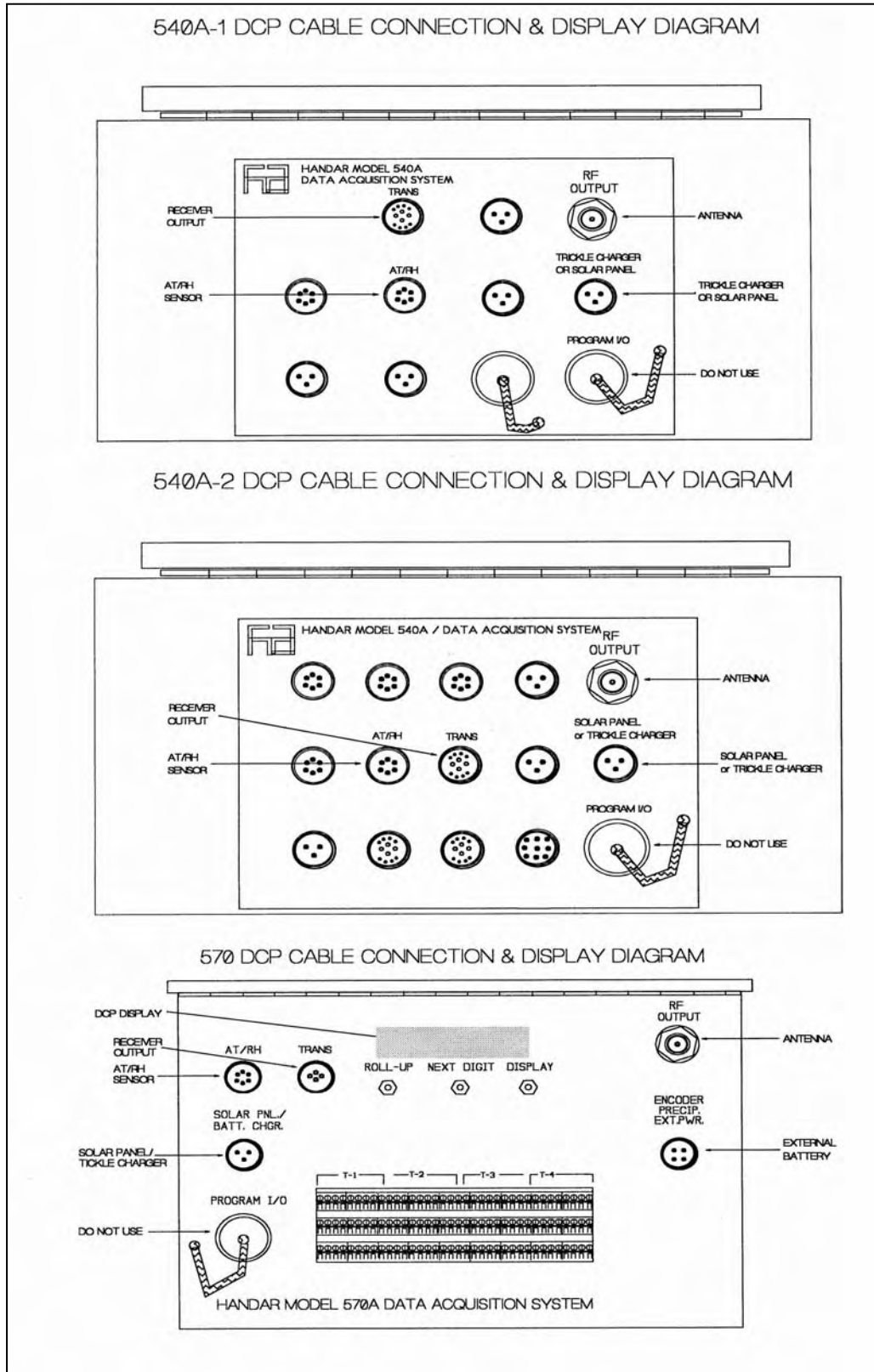

Figure 4-7. DCP Cable Connection and Display Diagram.

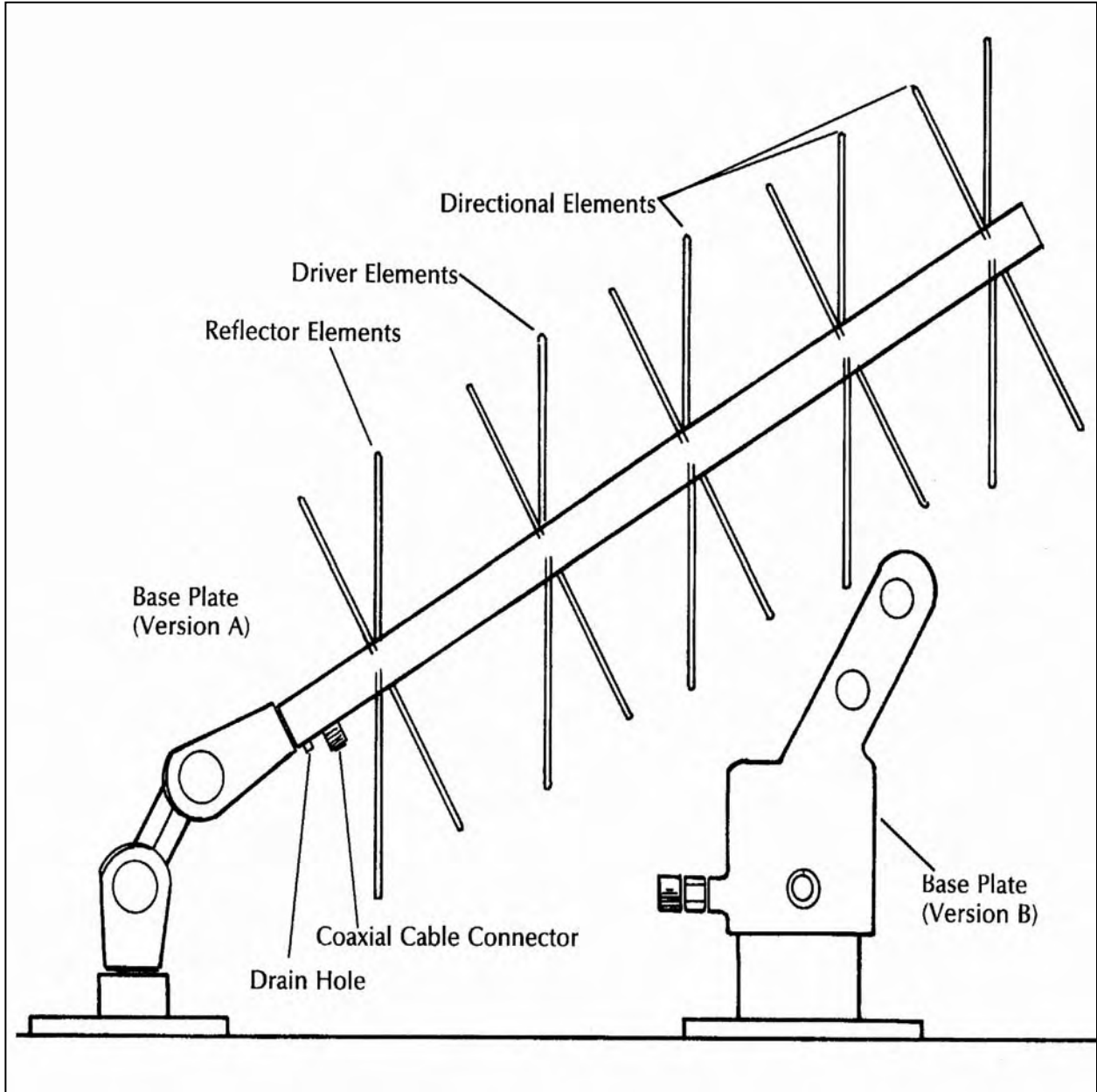

Figure 4-8. DCP Antenna Component Diagram.

ANTENNA ALIGNMENT

The site-specific antenna azimuth (compass heading) and elevation angle (degrees from horizontal) for IMPROVE sites are provided in Table 4-1, DCP Antenna Alignment for IMPROVE Sites. A compass should be used to check the approximate antenna azimuth. The elevation angle should be checked using the angle indicator supplied with the on-site tool kit. If either the azimuth or elevation angle are more than five degrees off from the values in Table 4-1, the antenna should be realigned to the specified values. The table will be updated as necessary (a shift in the satellite longitude may require a change in antenna azimuth and elevation).

CABLE AND CONNECTOR INSPECTION

Inspect the DCP antenna cable for rodent damage or chafing. The antenna cable connectors should be checked for tightness at both ends. If the cable appears to be damaged, call ARS for a replacement cable.

Table 4-1

DCP Antenna Alignment for IMPROVE Sites

Site	Site Longitude		Site Latitude		Magnetic Declination	Satellite Longitude	True Bearing	Elevation Angle	Antenna Azimuth
BADL	101	54	43	47	9.6	139.5	228.06	27.18	218.46
BAND	106	16	35	47	10.8	139.5	228.25	35.69	217.45
BIBE	103	12	29	21	8.8	139.5	236.29	37.78	227.49
BRID	109	47	42	56	13.8	139.5	219.96	32.14	206.16
CANY	109	49	38	28	12.8	139.5	220.50	35.83	209.70
GLAC	113	56	48	33	17.0	139.5	212.55	29.09	195.55
GRCA	112	0	36	0	13.0	139.5	221.53	39.14	208.53
GRCW	112	7	36	4	13.0	139.5	221.34	39.15	208.34
GRBA	114	13	39	0	14.3	139.5	216.89	37.80	202.59
GUMO	114	49	31	50	9.7	139.5	232.69	37.43	222.99
PEFO	109	48	34	54	12.0	139.5	224.91	38.66	212.91
ROMO	105	35	40	22	11.3	139.5	226.00	32.00	215.00
SAGO	116	55	34	12	13.6	139.5	217.00	44.00	203.00

4.2.4 Solar Power System Troubleshooting

Because solar panel power systems are wired in parallel, an individual, bad panel may not easily be identified aside from obvious physical damage; however, there is not much that can go wrong with a solar panel. The most common problems will be with the cables, regulators, or the deep-cycle storage batteries. If a problem with the solar panel power system is suspected, refer to the servicing and maintenance procedures described in TI 4110-3100, *Routine Site Operator Maintenance Procedures for LPV-2 Transmissometer Systems (IMPROVE Protocol)*. These sections fully describe the procedures for checking the status of the solar panels, M16 voltage regulators, and the deep-cycle storage batteries. After performing these checks, call ARS to relate the results and receive further instructions.

4.2.5 AC Power System Troubleshooting

CAUTION: Working with AC power can be dangerous! Extreme care must be used when troubleshooting any AC power system. Do not approach any system where cut or bare wires or standing water are present. If physical damage to any component of the AC power system (outlets, wiring, circuit breakers, etc.) is noted, leave the site immediately and contact ARS. If you have any concerns regarding your ability to safely troubleshoot the system, contact your unit electrician for assistance.

AC POWER STATUS

Verify that AC power is available at the outlet that the surge protector is plugged into. This check can be performed using the AC circuit tester (if available). Unplug the surge protector from the outlet and plug the circuit tester into the same socket. If the circuit tester indicates that AC power is not present at this outlet, check the status of the circuit breaker that provides power to the instrument shelter. If you do not know the location of this circuit breaker, contact your unit electrician.

TRIPPED CIRCUIT BREAKER

If the AC power status check performed above reveals that the circuit breaker has tripped, the problem may be due to a malfunction of a transmissometer component. To check for an instrument malfunction, proceed with the following:

- Disconnect the DC power supply (transmitter or receiver sites) and the DCP trickle charger (receiver sites only) from the surge protector.
- Reset the circuit breaker. If the breaker trips, consult an electrician.

TRIPPED CIRCUIT
BREAKER (continued)

- If the breaker does not trip, try to isolate the faulty component by reconnecting each component to the surge protector one at a time. Note the circuit breaker status as each component is reconnected. If the breaker trips when a component is plugged in, leave that component unplugged and continue the check; contact ARS with the results.
- If either the DCP trickle charger or the power supply are malfunctioning, leave the units unplugged and contact ARS for replacement components.

SURGE PROTECTOR

Check the status of the surge protector following the procedures described in TI 4110-3100, *Routine Site Operator Maintenance Procedures for LPV-2 Transmissometer Systems (IMPROVE Protocol)*.

TABLE OF CONTENTS

<u>Section</u>	<u>Page</u>
1.0 PURPOSE AND APPLICABILITY	1
2.0 RESPONSIBILITIES	1
2.1 Project Manager	1
2.2 Field Specialist	1
2.3 Data Analyst	2
2.4 Instrument Technician	2
2.5 Site Operator	2
3.0 REQUIRED EQUIPMENT AND MATERIALS	3
4.0 METHODS	6
4.1 General Information	6
4.2 Transmissometer and Support Equipment Troubleshooting	8
4.2.1 Transmitter Troubleshooting	8
4.2.2 Receiver Troubleshooting	10
4.2.3 Datalogging System Troubleshooting	13
4.2.4 AC Power System Troubleshooting	15

LIST OF FIGURES

<u>Figure</u>	<u>Page</u>
2-1 LPV-3 Transmissometer Operator Log Sheet – Transmitter Station	4
2-2 LPV-3 Transmissometer Operator Log Sheet – Receiver Station	5
4-1 Transmitter Component Diagram	9
4-2 Transmitter Lamp Chamber	10
4-3 Receiver Component Diagram	11
4-4 Receiver Computer Cards and Fuse Diagram	12
4-5 Junction Box Connector Panel in Support System	15

1.0 PURPOSE AND APPLICABILITY

This technical instruction (TI) describes on-site troubleshooting procedures to be followed when a malfunction of the Optec LPV-3 transmissometer station (LPV-2 receiver and LPV-3 transmitter) operated according to IMPROVE Protocol. The purpose of on-site troubleshooting is to assure quality data capture and minimize data loss by performing operational checks on transmissometers, data acquisition systems, and support equipment that will either identify the probable source of a system malfunction, or verify proper system operation.

This TI, as referenced from Standard Operating Procedure (SOP) 4110, *Transmissometer Maintenance (IMPROVE Protocol)*, serves as a guideline for:

- Transmitter system operational verification.
- Receiver system operational verification.
- Datalogging system operational verification.
- Line power (AC) system operational check.

Due to variations in the site configurations of IMPROVE Protocol sites, portions of this TI may not apply to every transmissometer station.

2.0 RESPONSIBILITIES

2.1 PROJECT MANAGER

The project manager shall:

- Coordinate with the site operator, his/her supervisor, field specialist, and data analyst concerning the schedule and requirements for specific troubleshooting procedures.
- Oversee and review specific troubleshooting procedure documentation completed by the site operator, field specialist, or data analyst for accuracy and completeness.

2.2 FIELD SPECIALIST

The field specialist shall:

- Coordinate with the site operator, his/her supervisor, project manager, and data analyst concerning the schedule and requirements for specific troubleshooting procedures.
- Train the site operator in troubleshooting procedures necessary for on-site resolution of instrument problems.

- Provide technical support to the site operator via telephone to assure identification and resolution of instrument problems.
- Document all technical support provided to the site operator.
- Resolve problems reported by the site operator.

2.3 DATA ANALYST

The data analyst shall:

- Coordinate with the site operator, his/her supervisor, project manager, and field specialist concerning the schedule and requirements for troubleshooting procedures.
- Identify possible instrument malfunctions and contact the site operator to schedule troubleshooting visits.
- Verify that scheduled visits are performed and notify the site operator if he/she fails to make a scheduled visit.
- Provide technical support to the site operator via telephone to identify and resolve instrument problems.
- Document all technical support provided to the site operator.
- Review documentation completed by the site operator for accuracy and completeness.
- File all hard copy site documentation.
- Ship supplies, tools, and replacement instrumentation necessary for instrument problem resolution to the site operator.
- Enter all correspondence with site operators and the results of all performed procedures into the site-specific timeline.

2.4 INSTRUMENT TECHNICIAN

The instrument technician shall provide technical support to the data analyst in identifying and interpreting instrument problems.

2.5 SITE OPERATOR

The site operator shall:

- Coordinate with his/her supervisor, project manager, field specialist, and data analyst concerning the schedule and requirements for specific troubleshooting procedures.

- Perform procedures described in this TI in response to direction provided by the data analyst or field specialist.
- Thoroughly document all troubleshooting procedures on the LPV-3 Transmissometer Operator Log Sheets (see Figures 2-1 and 2-2) and mail and fax the log sheets to the data analyst.
- Report any noted inconsistencies immediately to the data analyst or field specialist.

3.0 REQUIRED EQUIPMENT AND MATERIALS

Equipment required to support troubleshooting includes:

- Keys for shelters and padlocks
- On-site transmissometer receiver tool kit that includes:
 - Medium and small flat-blade screwdriver
 - Medium and small Phillips-head screwdriver
 - Medium adjustable wrench
 - Pliers
 - Battery terminal cleaner
 - Wire cutters
 - Flashlight
 - Wire ties
 - AA batteries (four) for receiver computer
 - Pen or pencil
 - Utility knife
 - Allen wrench set
 - Blower (photographic) brush
 - Signal mirror
 - AC circuit tester
 - Compass
 - Angle indicator
- On-site transmissometer transmitter tool kit that includes:
 - Small flat-blade screwdriver
 - Pen or pencil
 - Flashlight
 - Blower (photographic) brush
 - Signal mirror
 - AA batteries (four) for the control box)



**LPV-3 TRANSMISSOMETER OPERATOR LOG SHEET
TRANSMITTER STATION**

Date _____ Local Time _____ Operator(s) _____ Location _____
Weather Conditions _____
Visibility Conditions: Excellent Good Fair Poor Estimated visual range _____ miles
Details _____

INITIAL CONDITION

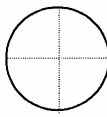
- Instrument Number LPV- _____ Display Screen _____ Lamp Number _____
- Mark the INITIAL location of receiver shelter window with a "+" in the circle below.

Comments _____
IMPORTANT: RETURN FLIP MIRROR TO PROPER (ON) POSITION.
- Initial Window Cleanliness: Good Moderate Poor
Comment _____
- Does the instrument appear to be working properly? Yes No Details: _____

SERVICING

- Was the alignment corrected? Yes No If Yes, time aligned _____
- Window Cleaned? Yes No If Yes, time cleaned _____
- Lens Inspected? Yes No If Yes, lens cleaned? Yes No
IMPORTANT: USE ONLY THE BLOWER BRUSH TO CLEAN THE TELESCOPE LENS.

TIMING

- Is your watch synchronized with NIST time? (telephone 303-499-7111 or <http://www.time.gov>) Yes No
- Transmitter Light ON, Exact Time, (HR:MIN:SEC) _____:_____:_____
- Transmitter Light OFF, Exact Time, (HR:MIN:SEC) _____:_____:_____
- Timing Reset? Yes No If Yes, time transmitter was reset _____
IMPORTANT: THE TRANSMITTER TIMING MUST ONLY BE RESET AT EXACTLY THE TOP OF THE HOUR!

SPECIAL SERVICING (upon ARS instruction)

- Lamp Changed? Yes No
Time lamp changed _____ New lamp number _____
IMPORTANT: IF LAMP IS CHANGED, RECEIVER COMPUTER CALIBRATION (CAL) NUMBER MUST ALSO BE CHANGED.
- Alignment corrected after lamp change? Yes No

GENERAL COMMENTS/SUPPLIES NEEDED

Send the white copy of this form to:
(keep the yellow copy on site)

Air Resource Specialists, Inc.
1901 Sharp Point Drive, Suite E
Fort Collins, CO 80525

Telephone: 1-800-344-5423
Fax: 1-970-484-3423

Figure 2-1. LPV-3 Transmissometer Operator Log Sheet - Transmitter Station.



**LPV-3 TRANSMISSOMETER OPERATOR LOG SHEET
RECEIVER STATION**

Date _____ Local Time _____ Operator(s) _____ Location _____

Weather Conditions

Visibility Conditions: Excellent Good Fair Poor Estimated visual range _____ miles
Details _____

INITIAL CONDITION

- Instrument Number LPV- _____ Local Time _____ Toggle: On Off
- Settings: Gain _____ Cal _____ Path _____ A1 _____ A2 _____ Integ _____ Cycle _____
- Switch A1 readings: B (b_{ext} reading) _____ C (raw reading) _____ VR(visual range km) _____
- Does the b_{ext} reading represent actual conditions? Yes No Comment _____

IMPORTANT: RETURN A1 SWITCH TO "C" (CYCLED MODE) OR "B" (CONTINUOUS MODE) AFTER CHECK.

- Mark the INITIAL location of transmitter light source with a "+" in the circle below.

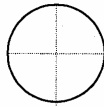

Comments _____

IMPORTANT: RETURN FLIP MIRROR TO PROPER (ON) POSITION.

- Initial Window Cleanliness: Good Moderate Poor Comment _____
- Does the instrument appear to be working properly? Yes No Details: _____
- Are all cables and connectors secure? Yes No Details: _____

SERVICING

- Was the alignment corrected? Yes No If Yes, time aligned _____
 - Window Cleaned? Yes No If Yes, time cleaned _____
 - Lens Inspected? Yes No If Yes, lens cleaned? Yes No
- IMPORTANT: USE ONLY THE BLOWER BRUSH TO CLEAN THE TELESCOPE LENS.**
- Is the junction box voltage lamp illuminated green? Yes No
 - Is the datalogger date and time correct? Yes No Comment _____
 - Record datalogger readings: *61A 01: _____ Ambient temperature (°C) A 05: _____ Toggle
A 02: _____ Relative humidity (%) *68A 08: _____ Internal battery voltage
A 03: _____ Extinction (1/km) A 09: _____ Power supply voltage
A 04: _____ Raw reading (counts)

IMPORTANT: RETURN THE DATALOGGER TO RUN MODE (*0).

TIMING

- Is your watch synchronized with NIST time? (telephone 303-499-7111 or <http://www.time.gov>) Yes No
 - Transmitter Light ON, Exact Time, (HR:MIN:SEC) _____:_____:_____
 - Receiver Toggle Update, Exact Time, (HR:MIN:SEC) _____:_____:_____
 - Transmitter Light OFF, Exact Time, (HR:MIN:SEC) _____:_____:_____
 - Updated Receiver Reading: C(raw reading) _____ B(b_{ext} reading) _____ Toggle: On Off
- IMPORTANT: RETURN A1 SWITCH TO "C" (CYCLED MODE) OR "B" (CONTINUOUS MODE) AFTER CHECK.**
- Does the updated b_{ext} reading represent your estimate of visual range? Yes No
Comment _____
- Computer Timing Reset? Yes No If Yes, time reset _____
- IMPORTANT: FOR PROPER RECEIVER COMPUTER TIMING RESET PROCEDURES, CALL ARS.**

AIR TEMPERATURE / RELATIVE HUMIDITY

- Do the datalogger AT/RH readings represent actual conditions? Yes No Comment _____
- Is the AT/RH aspiration fan operating? Yes No Comment _____
- Is the inlet screen clean? Yes No Comment _____

SPECIAL SERVICING (upon ARS instruction)

- Lamp changed at transmitter station? Yes No If yes, new lamp number _____
- IMPORTANT: IF LAMP IS CHANGED, RECEIVER COMPUTER CALIBRATION (CAL) NUMBER MUST ALSO BE CHANGED.**
- Receiver computer CAL number changed? Yes No If Yes, new CAL number entered: _____

GENERAL COMMENTS/SUPPLIES NEEDED

Send the white copy of this form to:
(keep the yellow copy on site)

Air Resource Specialists, Inc.
1901 Sharp Point Drive, Suite E
Fort Collins, CO 80525

Telephone: 1-800-344-5423
Fax: 1-970-484-3423

Figure 2-2. LPV-3 Transmissometer Operator Log Sheet - Receiver Station.

- Watch
- Site Operator's Manual for Transmissometer Monitoring Systems
- LPV Transmissometer Operator's Guide
- LPV-3 Transmissometer Operator Log Sheets (transmitter and receiver)
- Transmissometer component shipping cases
- Spare fuse kit, including:
 - 1-amp AGC glass fuse for transmissometer receiver computer
 - 3-amp AGC glass fuse for 5-amp power supply (for receiver station with AC line power)
 - 2.5-amp AGC glass fuse for 10-amp power supply (for transmitter station with AC line power)
 - 7-amp AGC glass fuse for junction box connector panel (receiver station)

If any tool(s) and/or equipment necessary to support troubleshooting procedures are not available, please contact ARS at 970/484-7941.

4.0 METHODS

This section includes two (2) major subsections:

4.1 General Information

4.2 Transmissometer and Support Equipment Troubleshooting

4.1 GENERAL INFORMATION

The majority of transmissometer problems are caused by:

- Misalignment.
- Incorrect system timing.
- Incorrect viewing mirror position.
- Inadequate power.

Many times operators can diagnose and solve instrument problems in the field, reducing costly site visits and minimizing data loss. Two good practices to follow in troubleshooting are: 1) start with the simple checks and progress towards the more complicated, and 2) break a system down into individually testable subsystems.

TROUBLESHOOTING

Many transmissometer system problems can be solved by checking items in the following categories:

- Obvious sources:
 - The power is unplugged or not turned on.
 - The flip mirror(s) are not in the correct position (ON).
 - The transmitter, receiver, or both are misaligned.
 - System timing is not synchronized (refer to TI 4110-3105, *Routine Site Operator Maintenance Procedures for LPV-3 Transmissometer Systems (IMPROVE Protocol)*).
 - Incorrect instrument settings.
- Power supply:
 - Battery voltage is not sufficient to run the system.
 - A fuse is blown in the receiver computer or in the power supply.
 - Incorrect polarity exists on power leads.
 - Power connectors are not making good contact (pins).
- Connectors:
 - A connector is not plugged in, or is in the wrong input position.
 - A connector is not making good contact.
 - Connector pins or sockets are damaged.
 - The cable/connector is damaged, resulting in a broken wire or electrical short.

BEFORE CALLING FOR ASSISTANCE

Before reporting problems or requesting assistance in diagnosing an instrument problem, please do the following:

- Check problem areas listed above (obvious sources, power supply, and connectors).
- Follow procedures for troubleshooting the component in question (see following sections).
- Have documentation of your tests available.
- Have a site operator's manual available.

Please call promptly with suspected or observed instrument problems. If the person you need to speak with is not in, ask to be directed to another or leave a message, including your name, location, telephone number, and a brief description of the problem(s) or need(s).

4.2 TRANSMISSOMETER AND SUPPORT EQUIPMENT TROUBLESHOOTING

4.2.1 Transmitter Troubleshooting

INOPERABLE TRANSMITTER

If the transmitter will not operate, check the following (refer to Figures 4-1 and 4-2):

- The power cable contacts at the battery are tight, and not corroded or covered with excessive deposits.
- The fuse in the power supply is not blown, or the power supply has not malfunctioned.
- The power connector is firmly tightened at the transmitter.
- If an error code is displayed on the transmitter screen.

ERROR CODES

If an error code is noted on the transmitter display screen:

ER=1

Usually indicates that the power supply voltage from a battery or power supply is failing (less than 10.6 volts). Recharge the battery or replace the power supply.

ER=2

The maximum safe power to the lamp has been exceeded. Replace the lamp.

ER=3

No signal is detected by the photodarlington. This indicates either a lamp or chopper failure. Check the lamp first, and then the chopper for proper operation.

- Is the lamp burned out or has the filament been damaged? If the lamp filament is broken, the power supply to the instrument should be turned off and the lamp should be removed. Telephone ARS for further instructions.
- Remove the lamp housing plate to hear if the chopper motor is running. Disconnect and re-connect the power cable to restart the transmitter unit. Upon restart the chopper motor should be heard starting up. If not, telephone ARS for further instructions.

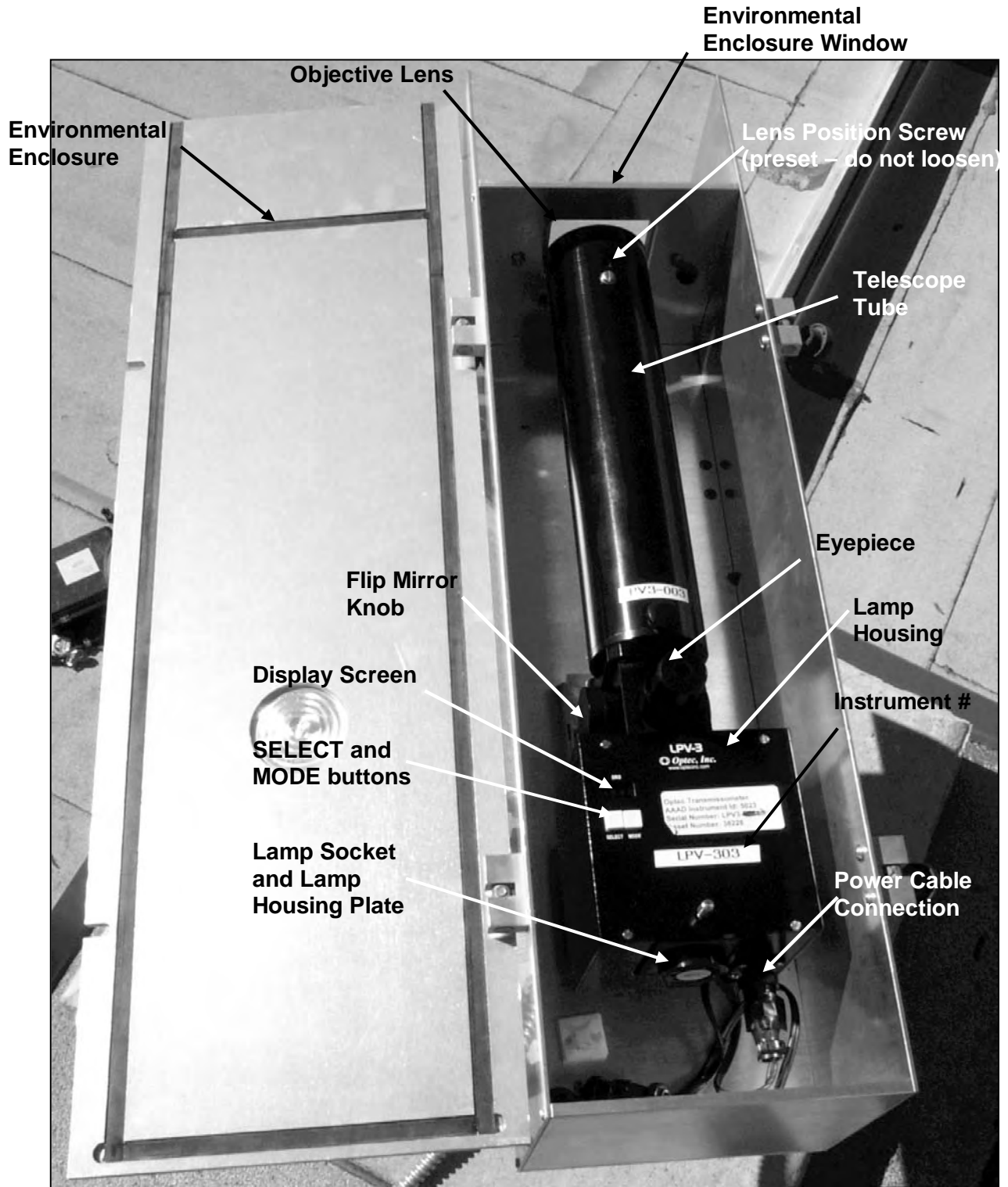

Figure 4-1. Transmitter Component Diagram.

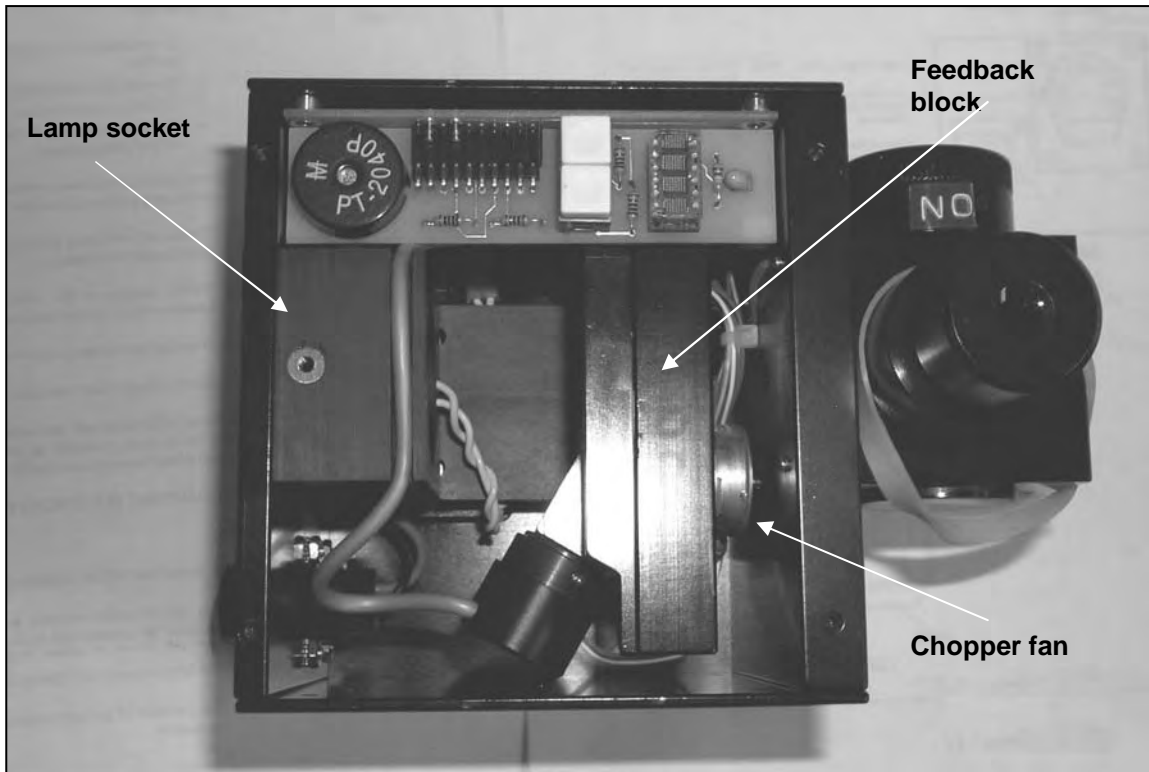

Figure 4-2. Transmitter Lamp Chamber.

ERROR CODES
(continued)

ER=4

The Real Time Chip has lost power and needs to be initialized. Call ARS for further instructions.

ER=5

This error code will only be displayed in the event that the transmitter is not operating continuously and the temperature of the circuitboard has exceeded 45 degrees Celsius. Call ARS for further instructions.

4.2.2 Receiver Troubleshooting

POWERING UP

When the receiver computer power is turned on, the computer will perform a series of internal checks and then set the front panel display to "000". The toggle light should be off. If the display does not go to "000" upon powering-up, there is a system or component failure; call ARS for further directions. (See Figure 4-3 for a diagram of the receiver computer front panel).

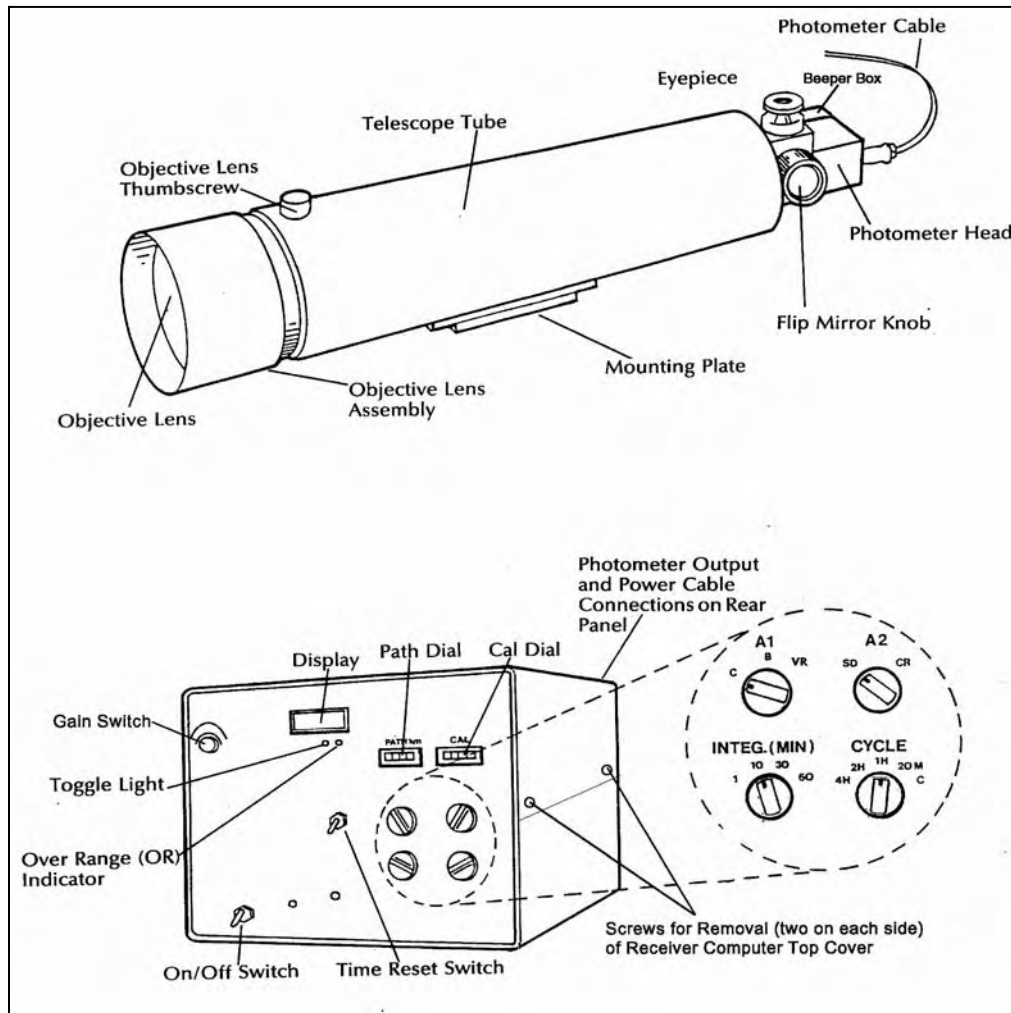

Figure 4-3. Receiver Component Diagram.

**BLANK RECEIVER
DISPLAY**

If the receiver display is blank with the power switch ON (especially common after a power surge, lightning strike, or after reinstallation of the receiver computer after the computer has been recently shipped from ARS), check the singleboard computer, front panel board, and ribbon cables in the receiver unit and for a damaged fuse in the receiver (see below).

**SINGLEBOARD
COMPUTER, FRONT
PANEL BOARD, AND
RIBBON CONNECTORS**

If the receiver display is blank, check the singleboard computer and front panel board to make sure they are firmly attached to the walls, and that the two ribbon connectors are in place and attached.

Remove the four small screws (two on each side) from the sides of the receiver computer and lift the computer top cover off, the check the singleboard computer and front panel board.

**DAMAGED FUSE IN
RECEIVER COMPUTER**

With the receiver cover removed, check the fuse for damage. Refer to Figure 4-4, Receiver Computer Cards and Fuse Diagram, for location of the fuse. If the fuse is damaged, replace with a 1-amp fuse, replace the receiver computer top cover, and reset the receiver computer and system timing. Refer to TI 4110-3105, *Routine Site Operator Maintenance Procedures for LPV-3 Transmissometer Systems (IMPROVE Protocol)*.

**TOGGLE LIGHT
FLASHING**

If, during internal checks, the computer finds a problem on the memory card, the toggle light will flash at approximately one-second intervals upon powering up. If this occurs, call ARS for further directions.

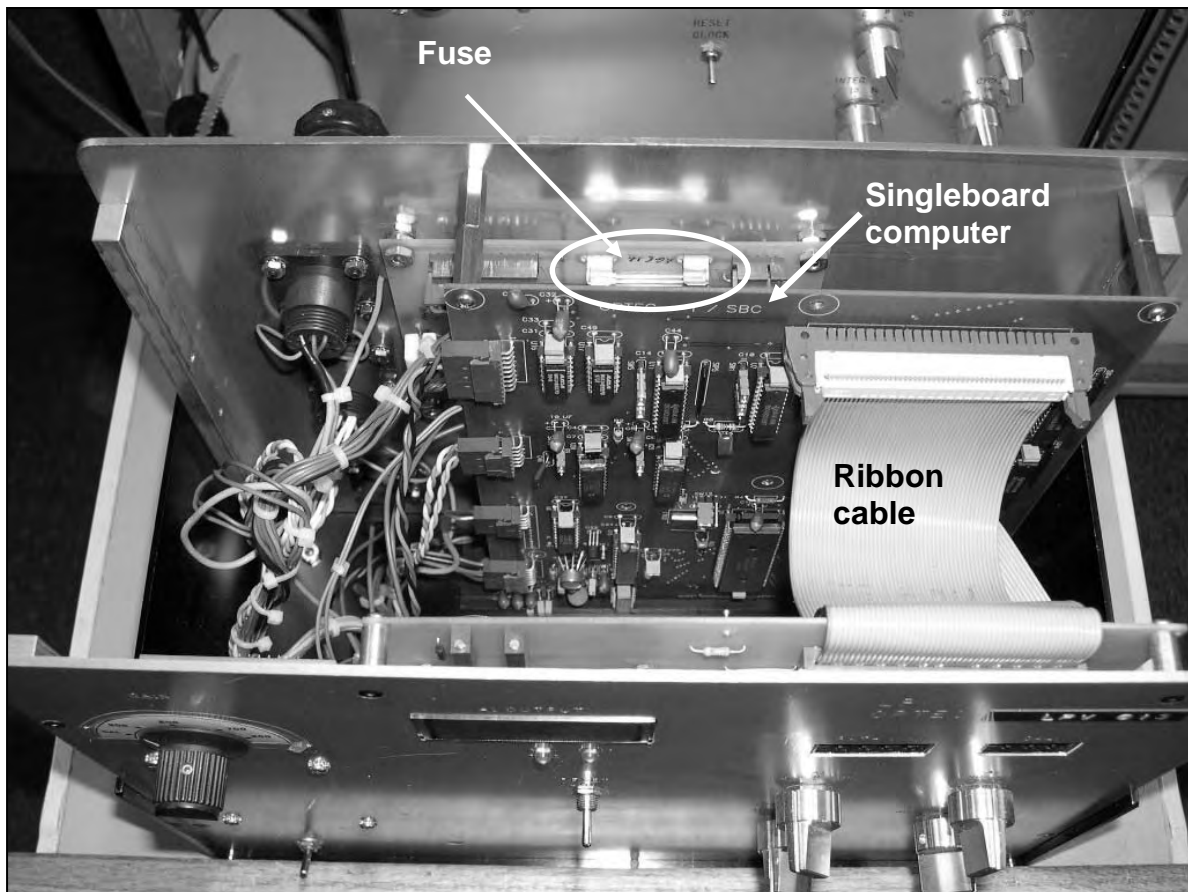

Figure 4-4. Receiver Computer Cards and Fuse Diagram.

TOGGLES DOES NOT
UPDATE

If the toggle light does not change state at the correct time:

- Check the system timing (refer to TI 4110-3105, *Routine Site Operator Maintenance Procedures for LPV-3 Transmissometer Systems (IMPROVE Protocol)*).
- The computer may be locked up. When this happens, both the toggle and the reading will stay the same until the computer is reset. Reset the computer by turning the power OFF for one second, and then turn the power switch back ON.
- After resetting the receiver computer, the system timing will need to be reset. (Refer to TI 4110-3105).
- The computer may be malfunctioning. Call ARS for further direction.

VERIFICATION OF
RECEIVER COMPUTER
INTEGRITY

To determine if the receiver computer reading is being properly relayed via the 23X datalogger, do the following:

Set the A1 switch to position “C” (raw instrument values) and “B” (extinction), and record the receiver computer display readings, date, time, and any other pertinent information on the receiver station log sheet.

Record the following current parameters from the 23X datalogger by entering *6 on the 23X keypad to access the parameters, and entering A to advance through the locations.

<u>Key Sequence</u>	<u>Display</u>	<u>Measurement Parameter</u>
*64A	04: _____	Transmissometer Raw Avg (Counts)
A	05: _____	Transmissometer Extinction Avg (1/km)

Call ARS to relate the recorded readings to the data analyst or field specialist and to receive further instructions. Return the completed log sheet (white copy) to ARS as soon as possible.

4.2.3 Datalogging System Troubleshooting

Datalogger operation and operational parameters used for diagnosing data transmission problems are monitored daily by ARS. Should these parameters indicate a potential datalogger problem, you will be contacted by the data analyst or field specialist with a request to perform one or more of the following datalogger system checks:

GENERAL PHYSICAL
CONDITION

Check for any accumulation of dirt or other contamination, damage, or other physical problems regarding the support system or its mounting hardware.

GREEN DC INDICATOR
LAMP

The green indicator lamp on the junction box connector panel in the support system (see Figure 4-5) indicates whether or not the datalogging systems 13.8 volt DC power supply is operating. The DC power supply provides power to operate the datalogging system. If the green indicator lamp is not illuminated, check to see if the DC fuse is blown. If the DC fuse is blown, replace it with a 7-amp AGC fast-blow glass fuse. If the fuse blows again, do not replace it. Call ARS immediately whenever a fuse has blown.

CABLES AND
CONNECTORS
INSPECTION

The datalogging support system cables connect the support system to the transmissometer, AT/RH sensor, telephone line, DC power, and computer interface (if present) through connectors on the bottom of the enclosure. Check the cables and connectors. Verify that all cables are secure and check the integrity of the cables. Document any problems, including broken connectors, loose or bare wires, etc. If the cables appear to be damaged, call ARS for a replacement cable.

CHECK DATALOGGER
DISPLAY READINGS

Record the following current parameters from the 23X datalogger by entering *6 on the 23X keypad to access the parameters, and entering A to advance through the locations.

<u>Key Sequence</u>	<u>Display</u>	<u>Measurement Parameter</u>
*61A	01:_____	Ambient temperature (°C)
A	02:_____	Relative humidity (%)
A	03:_____	Transmissometer extinction (1/km)
A	04:_____	Transmissometer raw reading (counts)
A	05:_____	Toggle light
*68A	08:_____	Datalogger internal battery voltage
(VDC)		
A	09:_____	Power supply (VDC)

Verify that the datalogger recorded conditions appear similar with the receiver display and current meteorological conditions.

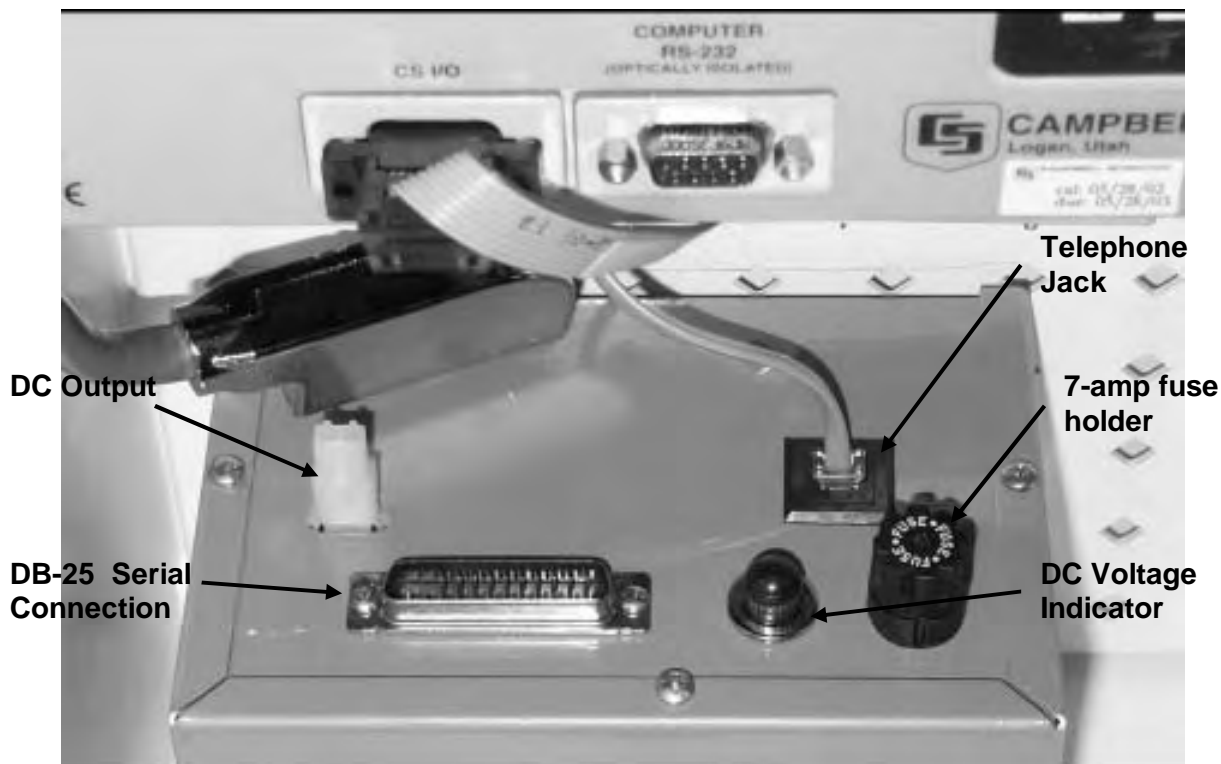

Figure 4-5. Junction Box Connector Panel in Support System.

4.2.4 AC Power System Troubleshooting

CAUTION: Working with AC power can be dangerous! Extreme care must be used when troubleshooting any AC power system. Do not approach any system where cut or bare wires or standing water are present. If physical damage to any component of the AC power system (outlets, wiring, circuit breakers, etc.) is noted, leave the site immediately and contact ARS. If you have any concerns regarding your ability to safely troubleshoot the system, contact your unit electrician for assistance.

AC POWER STATUS

Verify that AC power is available at the outlet that the surge protector is plugged into. This check can be performed using the AC circuit tester provided in the on-site tool kit. Unplug the surge protector from the outlet and plug the circuit tester into the same socket. If the circuit tester indicates that AC power is not present at this outlet, check the status of the circuit breaker that provides power to the instrument shelter. If you do not know the location of this circuit breaker, contact your unit electrician.

TRIPPED CIRCUIT BREAKER

If the AC power status check performed above reveals that the circuit breaker has tripped, the problem may be due to a malfunction of a transmissometer component. To check for an instrument malfunction, proceed with the following:

TRIPPED CIRCUIT
BREAKER (continued)

- Disconnect the DC power supply (transmitter or receiver sites) and the DCP trickle charger (receiver sites only) from the surge protector.
- Reset the circuit breaker. If the breaker trips, consult an electrician.
- If the breaker does not trip, try to isolate the faulty component by reconnecting each component to the surge protector one at a time. Note the circuit breaker status as each component is reconnected. If the breaker trips when a component is plugged in, leave that component unplugged and continue the check; contact ARS with the results.
- If any of the power supplies are malfunctioning, leave the units unplugged and contact ARS for replacement components.

SURGE PROTECTOR

Check the status of the surge protector following the procedures described in TI 4110-3105, *Routine Site Operator Maintenance Procedures for LPV-5 Transmissometer Systems (IMPROVE Protocol)*.

QUALITY ASSURANCE/QUALITY CONTROL DOCUMENTATION SERIES	
TITLE	TRANSMISSOMETER MONITORING SYSTEM DIAGRAMS AND COMPONENT DESCRIPTIONS
TYPE	TECHNICAL INSTRUCTION
NUMBER	4110-3350
DATE	APRIL 1994

AUTHORIZATIONS		
TITLE	NAME	SIGNATURE
ORIGINATOR	J. Carter Blandford	
PROJECT MANAGER	Mark Tigges	
PROGRAM MANAGER	David L. Dietrich	
QA MANAGER	Gloria S. Mercer	
OTHER		

REVISION HISTORY			
REVISION NO.	CHANGE DESCRIPTION	DATE	AUTHORIZATIONS
0.1	Add discussion of beeper box/references	August 1996	
1.0	Add LPV-3 systems / delete strip charts.	September 2005	

TABLE OF CONTENTS

<u>Section</u>		<u>Page</u>
1.0	PURPOSE AND APPLICABILITY	1
2.0	RESPONSIBILITIES	1
2.1	Project Manager	1
3.0	REQUIRED EQUIPMENT AND MATERIALS	1
4.0	METHODS	1
4.1	Optec LPV-2 and LPV-3 Transmissometer	2
4.1.1	Transmitter Component Descriptions	3
4.1.2	Receiver Component Descriptions	5
4.2	Datalogging Configuration	11
4.2.1	Datalogging Configuration Using a DCP	11
4.2.1.1	Data Collection Platform (DCP) Component Description	12
4.2.1.2	DCP Antenna Component Description	13
4.2.2	Datalogging Configuration Using a 23X Datalogger	14
4.2.2.1	Major Sub-Components	15
4.2.2.2	Connector Panel Connector Locations	15
4.2.2.3	Junction Box	15
4.2.2.4	Campbell 23X Datalogger Wiring	17
4.2.2.5	Receiver Signal Cable	18
4.3	Ambient Air Temperature and Relative Humidity Sensor	18
4.4	Transmitter and Receiver Shelters	19
4.5	System Power Configuration	19
4.5.1	Line Power (AC) Component Description	19
4.5.2	Solar Power (DC) Component Description	20
5.0	REFERENCES	21

LIST OF FIGURES

<u>Figure</u>		<u>Page</u>
4-1	Transmitter Component Diagram	22
4-2	Transmitter Lamp Housing	23
4-3	Transmitter Control Box Diagram (LPV-2 only)	24

LIST OF FIGURES (CONTINUED)

<u>Figure</u>		<u>Page</u>
4-4	LPV-3 Transmitter Components	25
4-5	Receiver Component Diagram	26
4-6	Receiver Computer Cards and Fuse Diagram	27
4-7	Receiver Computer Cable Connections Diagram	28
4-8	Receiver Computer Output and Power Connector Description	29
4-9	DCP Transmission Channel Switches Diagram	30
4-10	DCP Component Diagram	31
4-11	DCP Cable Connection and Display Diagram	32
4-12	DCP Antenna Component Diagram	33
4-13	DCP Antenna Cable Connection Diagram	34
4-14	23X Enclosure Components	35
4-15	23X Enclosure Connector Panel	36
4-16	Junction Box Connector Panel	36
4-17	Internal Wiring of Junction Box	37
4-18	Schematic of Internal Wiring of Junction Box	37
4-19	Campbell Scientific 23X Datalogger	38
4-20	AT/RH Sensor and Cable Diagram	39
4-21	Mounted AT/RH Sensor and DCP Antenna	40
4-22	Transmissometer System Shelters Diagram	41
4-23	Monitoring Component Diagram (Receiver and Transmitter Shelters)	42
4-24	Receiver and Transmitter Alti-Azimuth Bases	43
4-25	Line Power (AC) Components Diagram	44
4-26	Receiver Station Line Power (AC) Configuration Diagram	45
4-27	Transmitter Station Line Power (AC) Configuration Diagram	46

LIST OF FIGURES

<u>Figure</u>		<u>Page</u>
4-28	Solar Power Array Components (Receiver and Transmitter)	47
4-29	Receiver Station Solar Power (DC) Configuration Diagram	48
4-30	Transmitter Station Solar Power (DC) Configuration Diagram	49
4-31	M-16 Solar Panel Regulator Diagram	50
4-32	Deep-Cycle Battery and Interconnect Diagram	51

LIST OF TABLES

<u>Table</u>		<u>Page</u>
4-1	Major Components of the Transmissometer System	2
4-2	Internal Receiver Computer Analog Output Cable	9
4-3	Internal Receiver Computer Serial Output Cable	9
4-4	Photometer Cable	9
4-5	Transmissometer System Cable and Connector Description	11
4-6	Major Components of the Datalogging and Control Subsystem	15
4-7	Junction Box DB-25 Connector Wiring Description	16
4-8	Campbell 23X Datalogger Wiring Description	17
4-9	Receiver Signal Cable	18
4-10	Rotronics AT/RH Sensor Cable Wiring	18

1.0 PURPOSE AND APPLICABILITY

This technical instruction (TI) describes the individual components of IMPROVE LPV-2 and LPV-3 transmissometer systems, including:

- An Optec LPV-2 receiver.
- An Optec LPV-2 or LPV-3 transmitter.
- Datalogging configuration.
- An ambient air temperature and relative humidity sensor.
- Shelters or environmental enclosures and related hardware.
- System power configuration.

The descriptions in this TI may be used to maintain and/or troubleshoot the transmissometer system. Components in the transmissometer system may change depending on site logistics, component availability, and construction. This technical instruction includes the following information:

- Brief descriptions of component functions
- Component models, manufacturers, and suppliers
- System component diagrams
- Wiring diagrams
- Cable and connector descriptions

2.0 RESPONSIBILITIES

2.1 PROJECT MANAGER

The project manager shall ensure that the component descriptions in this TI are accurate, complete, and up-to-date.

3.0 REQUIRED EQUIPMENT AND MATERIALS

None.

4.0 METHODS

This section describes the system components and wiring of a transmissometer station and includes five (5) major subsections:

- 4.1 Optec LPV-2 and LPV-3 Transmissometer
- 4.2 Datalogging Configuration
- 4.3 Ambient Air Temperature and Relative Humidity Sensor
- 4.4 Transmitter and Receiver Shelters
- 4.5 System Power Configuration

4.1 OPTEC LPV-2 AND LPV-3 TRANSMISSOMETER

This section provides an overview of the Optec LPV-2 and LPV-3 transmissometer systems. Detailed component descriptions for the transmissometer are provided in the *Optec LPV-2 Long Path Visibility Transmissometer Technical Manual for Theory of Operation and Operating Procedures* (Optec, 1991), and *Model LPV-2 Receiver Model LPV-3 Transmitter Long Path Visibility Transmissometer Technical Manual for Theory and Operation and Operating Procedures* (Optec, 2003). Refer to Table 4-1 for transmissometer component, model, manufacturer, and supplier information.

Table 4-1

Major Components of the Transmissometer System

COMPONENT	MODEL	MANUFACTURER	SUPPLIER
LPV-2 Transmissometer System			
Transmissometer	LPV-2	Optec	Optec
Data Collection Platform (DCP)	570A	Handar	Handar
DCP	540A-1	Handar	Handar
DCP Antenna	443A	Handar	Handar
AT/RH Sensor	MP-100F	Rotronics	Rotronics
Receiver Alti-Azimuth Base	REC-AZ	Optec	Optec
Transmitter Alti-Azimuth Base	XMTR	Von	Von
Mounting Post	36-ADJ	Von	Von
Surge Protector	PLS I	Northern Technologies	Northern Technologies
Trickle Charger	SBP	ARS	ARS
5-amp Power Supply	72-280	Tenma	MCM
10-amp Power Supply	RPS-1012A	Tenma	MCM
Solar Panels	MSX-56	Solarex	Remote Power
Solar Panels	SX-20	Solarex	Remote Power
Solar Panel Regulator	M-16	Bobier	Hutton Communications
Deep-Cycle Batteries	GR27	NAPA	NAPA
LPV-3 Transmissometer System			
Transmissometer	LPV-2 Receiver	Optec	Optec
	LPV-3 Transmitter	Optec	Optec
Datalogger	23X	Campbell Scientific	Campbell Scientific
AT/RH Sensor	MP-100F	Rotronics	Rotronics
Receiver Alti-Azimuth Base	REC-AZ	Optec	Optec
Transmitter Alti-Azimuth base	XMTR	Von	Von
Mounting Post	36-ADJ	Von	Von
Surge Protector	ISOBAR4ULTRA	Tripp Lite	Tripp Lite
10-amp Power Supply	RPS-1012A	Tenma	MCM
Solar Panels	MSX-56	Solarex	Remote Power
Solar Panels	SX-20	Solarex	Remote Power
Solar Panel Regulator	M-16	Bobier	Hutton Communications
Deep-Cycle Batteries	GR27	NAPA	NAPA

4.1.1 Transmitter Component Descriptions

Refer to Figures 4-1, 4-2, 4-3, and 4-4 for the location of the following components. The figures are presented at the end of the section.

TRANSMITTER TELESCOPE

- FLIP MIRROR KNOB** The flip mirror knob changes the position of an internal mirror. When the knob is in its fully clockwise or OFF position, the image is directed to the eyepiece. When the knob is in its fully counterclockwise or ON position, the image is directed to the photodetector for measurement.
- EYEPIECE** The eyepiece is used to check and reposition transmitter alignment. An image of the scene with the view transposed left to right will be visible when the flip mirror knob is rotated fully clockwise. The reticle markings are super-imposed over the scene as an aid to alignment. The transmitter must be aligned so that the receiver is always within the center circle.
- IMPORTANT:** No readings are taken with the flip mirror in the OFF position. The beeper box will beep when the flip mirror is in the OFF position. It is to remind the operator to turn it to the ON position for instrument operation.
- LENS POSITION SCREW** The lens position screw holds the objective lens in position.
- IMPORTANT:** Do not attempt to focus the transmitter. Repositioning the objective lens will change the transmitter light output, requiring a recalibration.
- TELESCOPE TUBE** The telescope tube holds the objective lens at a constant distance (focus) from the lamp filament. The objective lens is used both to focus the image for alignment and to concentrate the outgoing light beam. The tube should always be mounted securely to the flip mirror assembly with the two Allen screws machined into the flip mirror block.
- LAMP HOUSING** The lamp housing contains the lamp, chopper system, and the optical feedback block. To avoid the possibility of contaminating the optical surfaces with dust, the housing should only be opened if servicing/troubleshooting is required.
- LAMP VOLTAGE CHECK SOCKETS** The lamp voltage check sockets are used to check the voltage of the lamp being used. A voltmeter has been provided. The positive lead will connect to the red socket and the negative lead will connect to the black socket – giving a lamp voltage reading. When

LAMP VOLTAGE CHECK
SOCKETS (continued) requested to check the lamp voltage, make sure the voltmeter settings are for DC volts (greater than 2 and less than 20). Take a reading when the lamp is ON under automatic control and document the reading on the Transmitter Operator Log Sheet.

LAMP HOUSING PLATE The lamp housing plate accurately positions the lamp socket which, in turn, accurately positions the lamp and its filament.

IMPORTANT: The plate should never be loosened; movement of the lamp housing plate will require factory servicing of the instrument. Access to the lamp housing is from the top.

HANDHELD RADIO
PRECAUTION The transmitter circuitry, especially the internal auto-timer, can be adversely affected by strong radio signals. Do not transmit on a handheld radio within 10 feet of the transmitter. Avoid aiming the antenna at, or over the circuitry. Strong radio signals may reset the internal auto-timer, resulting in incorrect system timing.

TRANSMITTER CONTROL BOX (LPV-2)

ON/OFF SWITCH The ON/OFF switch controls power to the control box (ON is when the switch is in the up position). The transmitter timekeeping circuitry runs from an internal battery and is not affected by the position of this switch. If power is applied to the transmitter when the auto-timer circuit is in the Operate mode, the lamp and chopper will come on. If the auto-timer is in the Wait mode, the light will not come on.

TEST SWITCH The TEST switch, present on units with serial numbers greater than four, is used to manually turn the transmitter ON without affecting the internal timekeeping circuitry. The lamp status LED will light when the TEST switch is in the up or TEST position. Keep in mind that the transmitter will not turn off when the TEST switch is moved to the OFF position (if the internal auto-timer is in the Operate mode).

LAMP STATUS LED The lamp status light indicates whether or not the lamp has aged or been damaged to the point where the optical feedback controller cannot keep the light output constant. The LED must be observed while the transmitter is ON under automatic control. If the LED is ON, the lamp needs to be replaced. The LED will always light when the TEST switch is used.

HANDHELD RADIO
PRECAUTION The transmitter circuitry, especially the internal auto-timer, can be adversely affected by strong radio signals. Do not transmit on a handheld radio within 10 feet of the transmitter. Avoid aiming the antenna at, or over the circuitry. Strong radio signals may reset the internal auto-timer, resulting in incorrect system timing.

TRANSMITTER POWER CABLE CONNECTIONS

POWER CABLE CONNECTION

A black two-conductor power cable from a power supply or battery connects to this input plug. Pin 2 of the plug is for +12 VDC and Pin 3 is for power return (-). Refer to Figure 4-8 for power connector description (LPV-2). Reversing polarity or connecting a supply voltage greater than 17 VDC will cause the fuse inside the control box to blow.

CONTROL CABLE CONNECTION (LPV-2 only)

The cable that carries power and signals from the control box to the transmitter telescope connects to these input plugs. Both ends of the cable are identical and are interchangeable. The connector is a “snap lock” type connector. When tightening the connector, a slight resistance will be felt just before the connector snaps into the locked position.

4.1.2 Receiver Component Descriptions

Refer to Figures 4-5, 4-6, 4-7, and 4-8 for the location of the following components. The figures are presented at the end of the section.

RECEIVER COMPUTER

ON/OFF SWITCH

The ON/OFF switch serves two purposes; it controls power to the computer, and acts as a computer reset. Upon powering up, the LCD display should, after a short period, display “000” to “001.” If the computer should lock up, the ON/OFF switch can be used to reset the system. Resetting is accomplished by holding the switch in the OFF position for at least one second before turning ON. Like the transmitter, the receiver’s auto-timer circuitry is powered by internal batteries and is not affected by the ON/OFF switch. The system timing, however, should be reset each time the computer power is cycled.

TIME RESET

The TIME RESET switch, when activated, resets the internal timer and defines the start times for the integration and cycle intervals. If settings on either the INTEG or CYCLE switches are changed, the internal timer must be reset. The TIMER RESET switch has no effect when the computer is set to the Continuous mode (INTEG = 1, CYCLE = C).

DISPLAY

The small LCD display, on the receiver computer front panel, displays readings as selected by the A1 switch. The range of the display for various readings is:

DISPLAY (continued)

- C Raw Instrument Readings.** The range is from “000” indicating no light is visible, to “999.” Raw readings should always be less than the calibration number. The higher the raw readings, the cleaner the air.
- B Extinction Values (in km^{-1}).** The range is from “.000” indicating impossibly clean air, to an extinction of “.999,” which corresponds to a visual range of 3.92 km. For visual ranges less than 3.92 km, “.999” will continue to be displayed. Extinction values should not go below 0.007, which is the calculated theoretical minimum of .009 minus instrument and rounding error of .002. The lower the extinction value, the cleaner the air.
- VR Visual Range (km).** The range of this setting is from 000 km, indicating no transmitter light was visible, to 999 km, an impossibly high value. The maximum possible visual range is 391 km. The higher the visual range, the cleaner the air.

A1 SWITCH

The A1 switch selects the computer output to both the front panel display and to analog line #1 used by the dataloggers (i.e., data collection platform).

- C** Raw instrument readings in counts
- B** Extinction values in units of km^{-1}
- VR** Visual range in units of km

In Operating mode, the A1 switch should remain on the “C” (raw readings) setting.

A2 SWITCH

The A2 switch selects the computer output to analog line #2 used by the dataloggers.

- SD** Standard deviation of the raw instrument readings
- CR** Raw readings count (the last of the ten 1-minute raw readings)

In Operating mode the A2 switch should remain on the “SD” (standard deviation) setting.

INTEG (MIN)

The INTEG switch selects the integration or averaging time period in minutes. The shortest possible time interval for a reading is one minute. A 10-minute averaged reading is, therefore, based upon ten 1-minute readings. A change in switch position requires that a time reset be made. For routine operation, this switch must remain on the “10” setting.

- CYCLE** The CYCLE switch selects the time interval between the start of each reading. A setting of “C,” for continuous, indicates there is no time delay or interval between readings. Other settings dictate time intervals of between 20 minutes and 4 hours. For example, a cycle time of 1 hour (1H) with the integration time of 10 minutes (10M), would provide a 10-minute average every hour. For routine operation, this switch must remain on the “1H” setting. A change in switch position requires that a time reset be made.
- GAIN SWITCH** The GAIN switch determines the fraction of the received raw signal digitized by the analog to digital (A/D) converter for use in the computer. The gain should only be changed by trained service technicians.
- OVER-RANGE (OR) INDICATOR** When the OVER-RANGE light is ON, it indicates that the value set from the computer to the display is too great for the display to handle. This may occur, for example, when a storm obscures the transmitter light. The receiver computer will then calculate an infinitely high extinction when the A1 switch is in the “B” position, and output a very high (over-range) value to the display. This condition is indicated by the over-range (OR) light. The display will show “1000,” its maximum value. The OR light will extinguish on its own after a within-range reading has been taken. For routine operation, the A1 switch is in the “C” position and the OR light should not illuminate.
- TOGGLE LIGHT** The toggle light indicates a reading update. At the end of the integration period, the toggle light will change state from ON to OFF or vice-versa. The toggle status is also output to the dataloggers. The toggle light has three important functions:
1. It indicates a computer lock-up or failure.
 2. It can be used to differentiate a computer lock-up from consecutive, identical readings.
 3. It provides the only visual indicator to reliably check the receiver auto-timer system.
- PATH DIAL** The path dial is used to input the line-of-sight distance between the transmitter and the receiver into the computer. The distance is measured during installation with a laser range finder and is expressed in kilometers. An incorrect distance setting will not affect the raw readings, but will result in the calculation of erroneous extinction values.

CAL DIAL

A calibration (CAL) number is calculated for each lamp. Since all lamps are slightly different, a new calibration number must be dialed in for each replacement lamp. The CAL number represents the raw reading which would be obtained if the atmosphere had a theoretical 100% transmission. The CAL number should not be changed, unless directed by ARS field service technicians.

HANDHELD RADIOS PRECAUTION

The receiver computer circuitry, especially the internal auto-timer, can be adversely affected by strong radio signals. Do not transmit on a handheld radio within 10 feet of the computer. Avoid aiming the antenna at, or over, the computer. Strong radio signals may reset the timer circuit, resulting in an incorrect, out-of-sync system timing.

RECEIVER CABLE CONNECTIONS

POWER CABLE CONNECTIONS

A black two-conductor power cable from the power supply or battery connects to this input plug. Pin 2 of the plug is for +12 VDC and Pin 3 is for power return (-). Reversing polarity or connecting a supply greater than 17 VDC will cause the fuse inside the receiver computer to blow.

OUTPUT CABLE CONNECTIONS

The cables that carry signals from the receiver computer to the datalogging system connect to these input plugs. The signals are differential – each signal has its own ground. Tables 4-2 and 4-3 detail the receiver computer analog and serial output cable wiring pin and color assignments.

PHOTOMETER CONNECTION

The cable that carries signals from the photometer (detector head) to the receiver computer connects to this input plug. Table 4-4 details the photometer cable wiring pin and color assignments.

Table 4-2

Internal Receiver Computer Analog Output Cable

PIN #	FUNCTION	SENSOR WIRE COLOR
1	12V DC Supply Positive	Red
2	12V DC Supply Negative	Black
3	Serial Receive	White
4	Serial Ground	Black
5	Serial Transmit	Red
6	Analog 1 Positive	White/Black
7	Analog 1 Negative	Blue
8	Analog 2 Positive	Green
9	Analog 2 Negative	Orange

Table 4-3

Internal Receiver Computer Serial Output Cable

PIN #	FUNCTION	SENSOR WIRE COLOR
1	Open	
2	Serial Receive	White
3	Serial Ground	Red
4	Open	
5	Serial Transmit	Black
6	Open	
7	Open	
8	Open	
9	Open	

Table 4-4

Photometer Cable

PIN #	FUNCTION	SENSOR WIRE COLOR
1	Negative 15 VDC	White
2	Positive 15 VDC	Black
3	Signal In	Red
4	Open	
5	Open	
6	Signal Common	Blue
7	Open	
8	Open	
9	Chassis Ground	Green

RECEIVER TELESCOPE

FLIP MIRROR KNOB

The flip mirror knob is used to change the position of an internal mirror. When the knob is in the fully clockwise or OFF position, the image is directed to the eyepiece. When the knob is in the fully counterclockwise or ON position, the image is directed toward the photodetector.

IMPORTANT: During alignment, the knob must be turned fully clockwise against the stop to the OFF position. If the knob is not positioned fully against the stop, incorrect alignment could occur. Once alignment is completed, the knob must be turned fully counterclockwise to the ON position. No readings will be taken if the flip mirror is left in the OFF position.

EYEPIECE

The eyepiece is used to check and reposition instrument alignment. As with the transmitter, an image of the scene with the view transposed left to right will be visible when the flip mirror knob is rotated fully clockwise. Reticule markings are superimposed on the scene for use in alignment. The transmitter light should be within the small inner circle.

OBJECTIVE LENS THUMBSCREW

The objective lens thumbscrew hold the objective lens assembly in place. The focus is set correctly during installation. Sometimes image degradation due to turbulence is mistaken as incorrect focus. Do not adjust the focus unless instructed by ARS. Receiver telescope focus adjustment will not affect the calibration.

OBJECTIVE LENS ASSEMBLY

The objective lens assembly on instruments with serial numbers 001-004 have aperture rings glued or taped in place over the end to allow a known amount of light collection by the telescope. These rings should always be firmly fixed in place. Later units have aperture rings built into the lens assembly.

OBJECTIVE LENS

The receiver telescope is equipped with an expensive objective lens. The delicate, coated, surface of this lens can easily be damaged or marked by incorrect cleaning. Field operators should avoid physically touching the lens; periodic cleaning of the surface with the blower brush is sufficient under normal circumstances.

TELESCOPE TUBE

The objective lens is held in place and the detector is shielded from stray light by a thick-walled telescope tube. A light-trapping baffle, mounted inside the tube, further protects the detector from stray light.

PHOTOMETER HEAD

The photometer head contains the photodiode detector, detector signal preamplification circuitry, filter, and the flip mirror. The photometer head must be securely attached to the telescope with the two Allen screws provided for this purpose.

4.2 DATALOGGING CONFIGURATION

This section provides an overview of the datalogging configuration used for collecting and disseminating data from an IMPROVE Protocol transmissometer system. Two datalogging configurations are described, one uses a DCP and the other uses a 23X datalogger as the main components of the systems.

4.2.1 Datalogging Configuration Using a DCP

Detailed component descriptions for the dataloggers and support equipment are provided in the Handar Data Acquisition System Operating and Service Manuals provided by Handar, Inc.

TRANSMISSOMETER SIGNALS Transmissometer signals exit the receiver computer at the port marked OUTPUT and enter the Handar 540A or 570A DCP at the port marked TRANS. The signals are differential, each signal having its own ground.

CONNECTOR PINOUTS Signal cabling and connectors are described in Table 4-5.

Table 4-5

Transmissometer System
Cable and Connector Description

FUNCTION	WIRE COLOR	DCP INPUT PIN #	MET CARD PIN #	INPUT ADDRESS	POWER ADDRESS	FULL SCALE	DCP CH #
b _{ext} Signal	Yellow	G	J2-8	6	8	1000	1
Raw Reading/ Stdev. Signal	White	B	J2-14	8	8	500	3
Toggle Signal	Orange	C	J1-12	9	8	001	2
b _{ext} Ground	Green	J	J1-8				
Raw Reading/ Std. Ground	Black	K	J2-10				
Toggle Ground	Brown	K	J2-10				
Not Used	---	---	---				
Not Used	---	---	---				
Shield	Bare	M	DCP				

Chassis/Grd.

- Comments:
1. Rec Output Cable – 6 feet DCP Input Cable – 8 feet; A1 determines Pin 1 output; A2 determines Pin 2 output.
 2. Receiver outputs double-ended; Handar DCP has common ground.
 3. DCP input pins not listed above:
 - Wire Color – Wires Not Used
 - A – Blue, J1-19 (5,B)
 - D – Gray, J1-6, (D,B)
 - E – Red, J1-15, (A,B)
 - F – Purples, J2-9, (F,B)
 - H – Not Used
- Leave extra wire at terminal strip end – do not trim.

4.2.1.1 Data Collection Platform (DCP) Component Description

Refer to Figures 4-9, 4-10, and 4-11 for the location of the following components.

ON/OFF SWITCH	<p>The main system ON/OFF switch is located next to the fuse holder near the hinge. <u>Do not</u> turn this switch OFF unless directed by ARS.</p> <p>IMPORTANT: If power is turned OFF, the internal program will be lost from memory and the unit will require reprogramming.</p>
FUSES	<p>Three fuses mounted in holders next to the ON/OFF switch protect the internal battery, an external battery (if used), and the program set power-output circuitry.</p> <p>IMPORTANT: Removal of the internal battery fuse will wipe out the program and will require a site visit or replacement DCP.</p>
BATTERY	<p>The 12 VDC, gel-cell battery secured in place at the end of the box powers the DCP. <u>Do not</u> attempt to measure the battery voltage unless instructed by ARS. Shorting the positive battery terminal to the holder with the test lead could cause damage to the circuitry or wipe out the program.</p>
DESICCANT INDICATOR	<p>The desiccant indicator affixed to the battery holder monitors the effectiveness of the desiccant. When the desiccant is in good shape or “active,” the color of the circle matches that of the rectangle. Both should be blue. When the desiccant is spent, the circle color will be pink. It is best to check the indicator immediately upon opening the DCP door as the color will change in approximately two minutes.</p>
DOOR CLOSURE CLAMPS	<p>All door closure clamps must be tightened to assure a good fit. Do not overtighten the clamps.</p>
SUPPORT CARD	<p>The support card contains the battery charging circuitry, system power supply, timer, and analog-to-digital converter. This card is always located in card slot # 9. Card slot # 1 is located closest to the battery.</p>
CPU CARD	<p>The CPU card contains the microprocessor, memory, and system firmware (operating system). This card is always placed in slot # 8 between the aluminum plates which act to shield it from interference.</p>

MET CARD	The meteorological sensor card provides signal conditioning for sensor inputs. It is here the transmissometer extinction analog signal is converted to a format that is usable by the computer. For use in our system, this card is always placed in slot #6. Two multi-color ribbon connectors bring sensor signals from the input panel to the met cards. Most DCPs have two pairs of ribbon cables, some may have three pairs. The pair marked TELEPHOTOMETER #1 or TRANSMISSOMETER, should be used with the shorter of the two cables connected to the left met card cable input (battery at top). The black conductor is on both cables.
GOES TRANSMITTER	The GOES transmitter circuit board, located on the inside of the door, enables the DCP to transmit data at precise user-selected frequencies to the satellite. The transmitter has the ability to broadcast at 265 frequencies between 401.701 and 402.0985 MHz in 1.5 kHz steps. The 10-watt transmitter power output is +40 dBm.
PRIMARY CHANNEL SWITCHES	There are six square, red, dial switches located in the upper-right corner (battery at top) of the GOES radio transmitter circuit board. The top three switches labeled CHAN 1 are used to set the primary radio frequency at which the DCP will transmit. These switches should always be set to the channel noted on the DCP sticker. When the primary channel switches are set to 900, transmissions from the DCP are hardware inhibited. This function is used in the field to disable a DCP for shipping, or to ship a new DCP from ARS to the field.
SECONDARY CHANNEL	The SECONDARY BROADCAST channel, CHAN 2, is not used in the transmissometer monitoring network. These switches should remain set to "000." The secondary channel is used in some monitoring networks to broadcast random transmissions when an emergency, such as a flood, occurs.
GRAY RIBBON CONNECTOR	The gray ribbon cable connecting the GOES radio to the CPU card should <u>never be unplugged</u> . The computer relies on clock signals generated by an oscillator on the GOES radio board for its operation. IMPORTANT: Disconnecting the gray ribbon cable will destroy the internal program requiring a site visit by ARS technicians or a replacement DCP.

4.2.1.2 DCP Antenna Component Description

The antenna used with the Handar 540A/570A DCP is a Cross-Yagi type with a gain of 10dB. The antenna has a half-power beam width of 47°, which means that critical alignment is not necessary. Refer to Figure 4-12 for the location of the following components.

BASE PLATE VERSION #A	The base plate used in many installations is chrome plated and adjustable in both the horizontal and vertical directions. The plate is usually mounted to the shelter with lag bolts or wood screws. The antenna bar screws to this base.
BASE PLATE VERSION #B	Another type of base plate in use is designed for post-mounting. With this type of mount, antenna alignment is a combination of the vertical component, adjusted with two bolts at the base of the antenna rod, and the rotational component adjusted with the two large Allen screws which clamp to the post.
DRAIN HOLES	At the base of the antenna bar, on all but the oldest units, are two holes which allow water that enters the bar to drain. These holes should remain uncovered and should be positioned towards the ground.
COAXIAL CABLE CONNECTOR	The coaxial cable from the DCP enters the antenna at this connector. The connector should be oriented towards the bottom of the bar if possible and should be screwed in tightly to avoid moisture penetrating the seal and degrading the signal. Refer to Figure 4-13 for a diagram of cable connections.
DRIVER ELEMENTS	The driver elements, located in the second position from the bottom on the antenna, are the elements that do all the work. For the transmissions to be strong enough to reach the satellite reliably, all four elements must be in good shape, and securely fastened in their holders.
REFLECTOR ELEMENTS	These antenna elements function almost like a mirror behind a light bulb, increasing the signal strength.
DIRECTIONAL ELEMENTS	These antenna elements further increase the output power, as well as make the signal more directional.

4.2.2 Datalogging Configuration Using a 23X Datalogger

The datalogging and control subsystem allows for remote data collection. This section describes connectors, internal wiring, and sub-components in the datalogging and control subsystem and contains the following subsections:

- 4.2.2.1 Major Sub-Components
- 4.2.2.2 Connector Panel Connector Locations
- 4.2.2.3 Junction Box
- 4.2.2.4 Campbell 23X Datalogger Wiring
- 4.2.2.5 Receiver Signal Cable

4.2.2.1 Major Sub-Components

Table 4-6 presents the category, manufacturer, supplier, and model number of the major components in the datalogging and control subsystem. Figure 4-14 shows the placement of the components within the enclosure.

Table 4-6

Major Components of the Datalogging and Control Subsystem

DATALOGGING AND CONTROL SUBSYSTEM COMPONENTS			
Category	Manufacturer	Supplier	Model
Datalogger	Campbell Scientific	Campbell Scientific	23X
Storage Module	Campbell Scientific	Campbell Scientific	SM4M or SM16M
Primary Modem	Campbell Scientific	Campbell Scientific	COM210
Solid State relay	Crydom	Newark	D5d10
13.8 VDC, 10 amp Power Supply	Tripp Lite	Newark	PR-10
Surge Protector	Tripp Lite	Newark	ISOBAR4ULTRA
AMP Connectors	AMP	Digikey	9-pin, 8-pin, and 4-pin
Telephone Line Surge Protector	Tripp Lite	Digikey	TeleSpike Blok
External UPS System	Tripp Lite	Digikey	BC-250

4.2.2.2 Connector Panel Connector Locations

The connector panel on the datalogging and control subsystem is on the underside of the enclosure. Figure 4-15 is a view of the connector panel from below the enclosure. The connector panel has the following connections:

- Male 9-pin connectors for the photometer, receiver computer, and ambient temperature/relative humidity (AT/RH) connections.
- Telephone jack for data collection.

4.2.2.3 Junction Box

Figure 4-16 is a photograph of the junction box connector panel. Figures 4-17 and 4-18 show a photograph of the internal wiring of the junction box as well as a schematic of the internal wiring of the junction box. Table 4-7 details the wiring schedule for the DB-25 junction box connection.

Table 4-7

Junction Box DB-25 Connector Wiring Description

PIN #	FUNCTION	INSTRUMENT	WIRE COLOR
1	Serial Receive	TRANS	Blue
2	Serial Ground	TRANS	Green
3	Serial Transmit	TRANS	Orange
4	A1 Channel Positive	TRANS	Green/Black/White
5	A1 Channel Negative	TRANS	Red/Green
6	A1 Ground	TRANS	Black
7	A2 Ground	TRANS	Red
8	12VDC Positive from 23X	AT/RH	Red/White
9	12VDC Negative from 23X	AT/RH	Black/White
10	Air Temperature Signal	AT/RH	Blue/Black
11	Relative Humidity Signal	AT/RH	Green/White
12	Open		Orange/Red
13	Open		Black/Red
14	12VDC Positive from 23X	WS	Red/Black/White
15	12VDC Negative from 23X	WS	Blue/White
16	WS Signal	WS	Orange/Black
17	Open	WS	Green/Black
18	12VDC Positive from 23X	WD	Black/White/Red
19	12VDC Negative from 23X	WD	White/Black/Red
20	12 VDC Negative from 23X	WD	Blue/Red
21	WD Signal	WD	Orange/Green
22	Power Supply Positive	TRANS	White/Red
23	Power Supply Negative	TRANS	Red/Black
24	Toggle Positive	TRANS	White
25	Toggle Ground	TRANS	White/Black

4.2.2.4 Campbell 23X Datalogger Wiring

The Campbell 23X datalogger performs all measurements and controls the functions of the datalogging and control subsystem. Figure 4-19 shows the front panel of the datalogger. Table 4-8 details the wiring connections to the datalogger.

Table 4-8

Campbell 23X Datalogger Wiring Description

TERMINAL	TO/FROM	WIRE COLOR
1H	Trans A1 Channel +	Green/Black/White
1L	Trans A1 Ground	Black
2H	Trans A1 Channel -	Red/Green
2L	Trans A2 Ground	Red
3H	Trans Toggle +	White
3L	Trans Toggle Ground	White/Black
4H		
4L		
5H	AT Signal	Blue/Black
5L	RH Signal	Green/White
5GND		
6H	Power Supply +	White/Red
6L	Power Supply -	Red/Black
7H		
EXCITATION 1		
EXCITATION 2		
EXCITATION GND		
EXCITATION 3		
EXCITATION 4		
EXCITATION 4 GND		
CAO 1		
CAO 2		
CAO GND		
CONTROL 1		
CONTROL 2		
CONTROL 3		
CONTROL 4		
CONTROL 5	Trans Serial transmit	Orange
CONTROL 6		
CONTROL GND	Trans Serial Ground	Green
PULSE INPUT 1		
PULSE INPUT 2		
PULSE INPUT GND		
PULSE INPUT 3		
PULSE INPUT 4		
PULSE INPUT GND		
12VDC+	12VDC+ from 23X	Red/White
12VDC-	12VDC- from 23X	Black/White

4.2.2.5 Receiver Signal Cable

The receiver signal cable provides the following functions for the transmissometer:

- RS-232 serial I/O (Receive, Transmit, Ground)
- Two analog output channels (A1, GND, A2, GND)

The cable assembly consists of the following components:

- A 9-Conductor, 22 AWG cable for serial and analog data lines
- Two 9-Pin AMP connectors (one on each end of the cable)

Table 4-9 details the cable wiring pin and wire color assignments.

Table 4-9
Receiver Signal Cable

PIN #	FUNCTION	SENSOR WIRE COLOR
1	A1 Channel Positive	Red
2	A2 Channel Positive	Black
3	Toggle Positive	White
4	A1 Ground	Blue
5	A2 Ground	Green
6	Toggle Ground	Orange
7	Serial Receive	Yellow
8	Serial Ground	Violet
9	Serial Transmit	Gray

4.3 AMBIENT AIR TEMPERATURE AND RELATIVE HUMIDITY SENSOR

Ambient air temperature and relative humidity are monitored with a Rotronics model MP-100F sensor. This sensor combines both measurements within one unit and is controlled by, and directly connected to, the datalogging system. Temperature is measured by a platinum RTD sensor, an electronic component whose resistance changes with temperature change. The relative humidity sensor measures humidity with a C-80 hygrometer, a device whose capacitance changes as its surface absorbs moisture. Refer to Figures 4-20 and 4-21 for a diagram of the sensor and cable, and of a sensor mounted to a receiver shelter. Table 4-10 details the Rotronics AT/RH sensor cable wiring pin and color assignments.

Table 4-10
Rotronics AT/RH Sensor Cable Wiring

PIN #	FUNCTION	SENSOR WIRE COLOR
1	AT/RH Fan 12V DC POS	Red
2	AT/RH Fan 12V DC NEG	Black
3	Open	
4	Air Temperature Signal	White
5	Relative Humidity Signal	Green
6	Open	
7	12V DC – 23X	Red
8	Ground – 23X	Black
9	Open	

SENSOR HOLDER The sensor is mounted in a white, parallel, plate shield that acts to dissipate heat and to protect the sensor. The design assures that heat from the shield is not conducted to the sensor causing errant, high readings.

SAMPLING FREQUENCY **Cycled mode (1-hr) operation:**
Air temperature (°F) and relative humidity (0% - 100%) measurements are taken once per hour at the same time other measurements are made. Under routine monitoring procedures, all sensors are scanned at 30 minutes past each hour.

Continuous mode operation:
Air temperature (°F) and relative humidity (0% - 100%) measurements are taken at 5-minute and 1-hour intervals.

4.4 TRANSMITTER AND RECEIVER SHELTERS

Both the transmitter and receiver operate under ambient conditions, but require waterproof sheltering. Refer to Figure 4-22 for a diagram of some of the different types of shelters and environmental enclosures used, and to Figure 4-23 for a diagram of monitoring component placement in the shelters. Refer to TI 4050-3010, *Site Selection for Optec LPV-2 Transmissometer Systems*, for a brief description of the components and hardware use in the shelters.

One of the most important components in each shelter is the alti-azimuth base. They are used for holding the telescopes in place and for the alignment adjustment that is critical for proper transmissometer operation. Refer to Figure 4-24 for a diagram of both the transmitter and the receiver alti-azimuth bases with the location of their telescope hold-down screws and their vertical and horizontal adjustment knobs. Refer to TI 4110-3100, *Routine Site Operator Maintenance Procedures for LPV-2 Transmissometer Systems (IMPROVE Protocol)* or TI 4110-3105, *Routine Site Operator Maintenance Procedures for LPV-3 Transmissometer Systems (IMPROVE Protocol)*, for a description of alignment correction procedures.

4.5 SYSTEM POWER CONFIGURATION

This section briefly describes the line power (AC) and the solar power (DC) components used for the LPV-2 and LPV-3 transmissometer systems. Detailed descriptions of each individual component are provided by the manufacturer and/or supplier of the respective component (see Table 4-1 for a listing of the major components, models, manufacturers, and suppliers).

4.5.1 Line Power (AC) Component Description

At some locations, the receiver, transmitter, or both stations operate from an AC power line. As all instrumentation and data collection equipment have the capability of operating from DC power, AC power is used to supply a constant source of power (unless interrupted by power outage/surge) to the receiver or transmitter power supply. An AC power system is comprised of the following components: a surge protector, a trickle charger (datalogging system Version 1), and a 10-amp power supply. The AC system can supply power to the power supply, and is unlike a solar system which can be affected by weather, however, the power supplies can be interrupted by a power outage or a power surge. Refer to Figures 4-25, 4-26, and 4-27 for the location of the following components.

SURGE PROTECTORS At site operating with line power (AC), surge protectors protect instruments from potentially damaging power surges.

The Northern Technologies' models used are a power-on switch and a system alert indicator light (red). If the red system alert light on either model surge protector is lit, it means that the surge protector has sustained a massive power surge and is no longer capable of providing protection. Call ARS for a replacement unit if the red system alert light is lit.

The Tripp Lite model used has a power-on switch, a protection indicator light (green), a fault indicator light (red), and a line OK indicator (green). If the red fault light is lit, use a different outlet or have the outlet wired properly. If the green "line OK" light is not lit, there may be no power coming into the unit. If the green protection light is not lit, the unit may have sustained damage as the result of a power surge. Call ARS for a replacement unit.

TRICKLE CHARGER Used to charge the DCP battery.

POWER A Tenma 10-amp power supply is used at the receiver and transmitter to supply power to the receiver computer and transmitter control box.

4.5.2 Solar Power (DC) Component Description

At some locations, the receiver, transmitter, or both stations, are powered from a solar system with the following components: solar panels, solar panel regulators, deep-cycle batteries, and interconnection cabling. The number of solar panels is based on the estimated hours of sunlight available. Transmitter stations will require at least two panels approximately 1.5' x 3' in size. Most receiver stations can operate from one such panel. DCPs are powered by one small (1.5' x 2') solar panel. Refer to Figures 4-28, 4-29, 4-30, 4-31, and 4-32 for the location of the following components.

SOLAR PANELS Solar panels produce electric current when illuminated with sunlight. Panels should be oriented towards true south, and are inclined to angles that are most efficient for winter operation (latitude plus 15°). A coating of dust or dirt on the glass surface will reduce collecting efficiency; procedures to clean the panels are described in TI 4110-3100, *Routine Site Operator Maintenance Procedures for LPV-2 Transmissometer Systems (IMPROVE Protocol)* or TI 4110-3105, *Routine Site Operator Maintenance Procedures for LPV-3 Transmissometer Systems (IMPROVE Protocol)*.

SOLAR PANEL OUTPUT The solar panels used in the transmissometer systems produce approximately 18 volts when fully illuminated. Procedures to troubleshoot solar panel power systems are described in TI

SOLAR PANEL OUTPUT (continued)	4110-3300, <i>Troubleshooting and Emergency Maintenance Procedures for LPV-2 Transmissometer Systems (IMPROVE Protocol)</i> or TI 4110-3305, <i>Troubleshooting and Emergency Maintenance Procedures for LPV-3 Transmissometer Systems (IMPROVE Protocol)</i> .
SOLAR PANEL REGULATOR	Electrical current produced by the solar panels is used to charge the deep-cycle batteries. A regulator prevents over-charging of the batteries during extended periods of sunny weather. The M-16 solar panel regulators are mounted inside the shelter (see Figure 4-31). Refer to TI 4110-3100, <i>Routine Site Operator Maintenance Procedures for LPV-2 Transmissometer Systems (IMPROVE Protocol)</i> or TI 4110-3105, <i>Routine Site Operator Maintenance Procedures for LPV-3 Transmissometer Systems (IMPROVE Protocol)</i> for a description of M-16 solar panel regulator operation.
DEEP-CYCLE BATTERIES	Deep-cycle batteries power equipment at both receiver and transmitter stations that are equipped with solar power supplies. The batteries are connected in parallel with interconnect cables going from the positive to positive and from the negative to negative (terminals), respectively. Regular maintenance and troubleshooting procedures for the deep-cycle batteries are provided in TI 4110-3100, <i>Routine Site Operator Maintenance Procedures for LPV-2 Transmissometer Systems (IMPROVE Protocol)</i> or TI 4110-3105, <i>Routine Site Operator Maintenance Procedures for LPV-3 Transmissometer Systems (IMPROVE Protocol)</i> .
INTERCONNECT WIRING	All power wiring used to interconnect solar panels and deep-cycle batteries should be labeled at the connectors. As a general rule, with red and black conductors, the red will be positive. As with all electrical or electronic conductors, it is very important to verify correct polarity before connecting to power; if unsure, call ARS for direction.

5.0 REFERENCES

- Handar, Inc., 1982, Operating and Service Manual for 540A Multiple Access Data Acquisition System, June.
- Handar, Inc., 1988, 570A Data Acquisition System Operating & Service Manual, March.
- Optec, Inc., 1991, Model LPV Long Path Visibility transmissometer, Version 2, Technical Manual for Theory of Operation and Operating Procedures, July.
- Optec, Inc., 2002, Model LPV-2 Receiver Model LPV-3 Transmitter Long Path Visibility Transmissometer, Revision 1, Technical Manual for Theory of Operation and Operating Procedures, August.

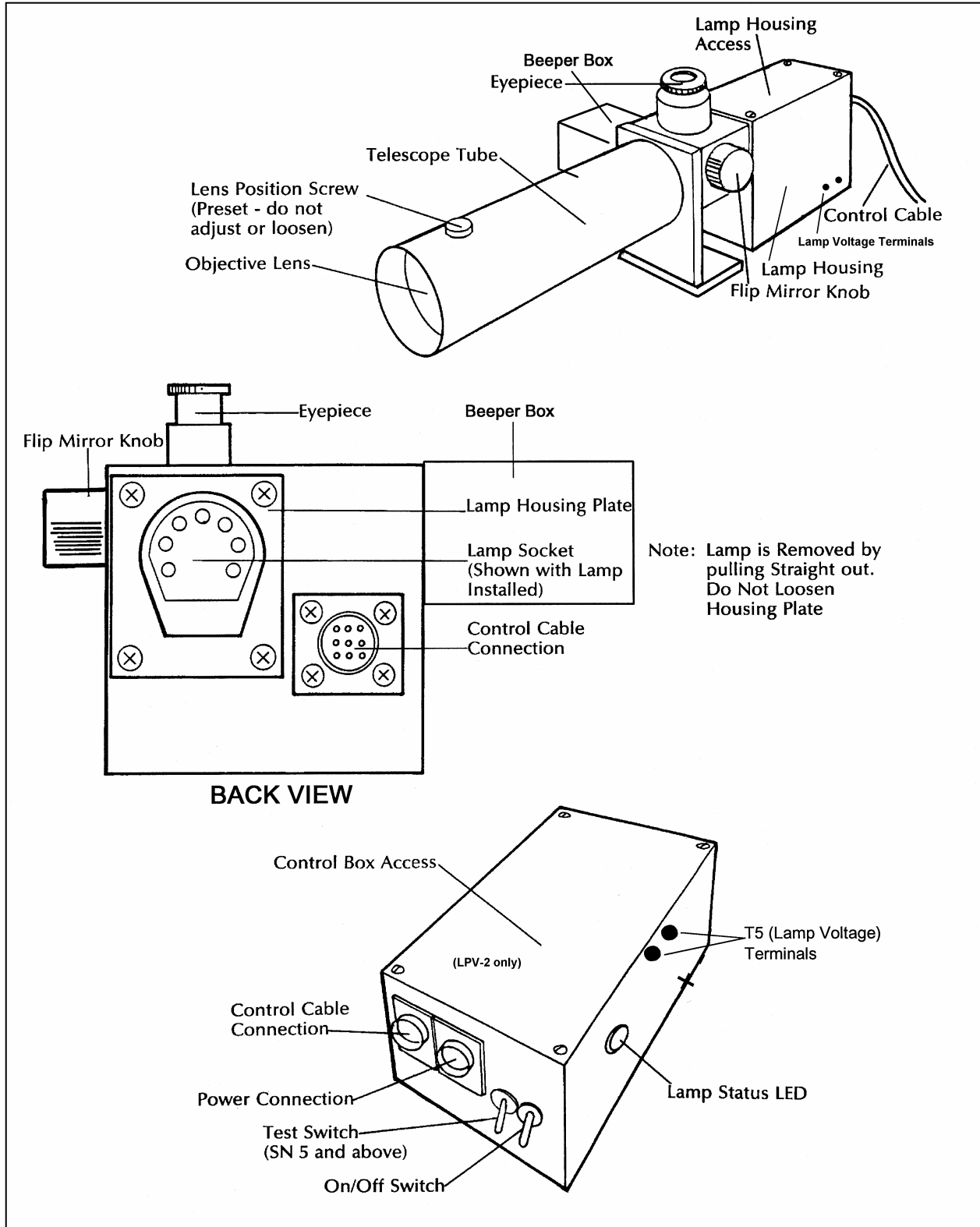

Figure 4-1. Transmitter Component Diagram.

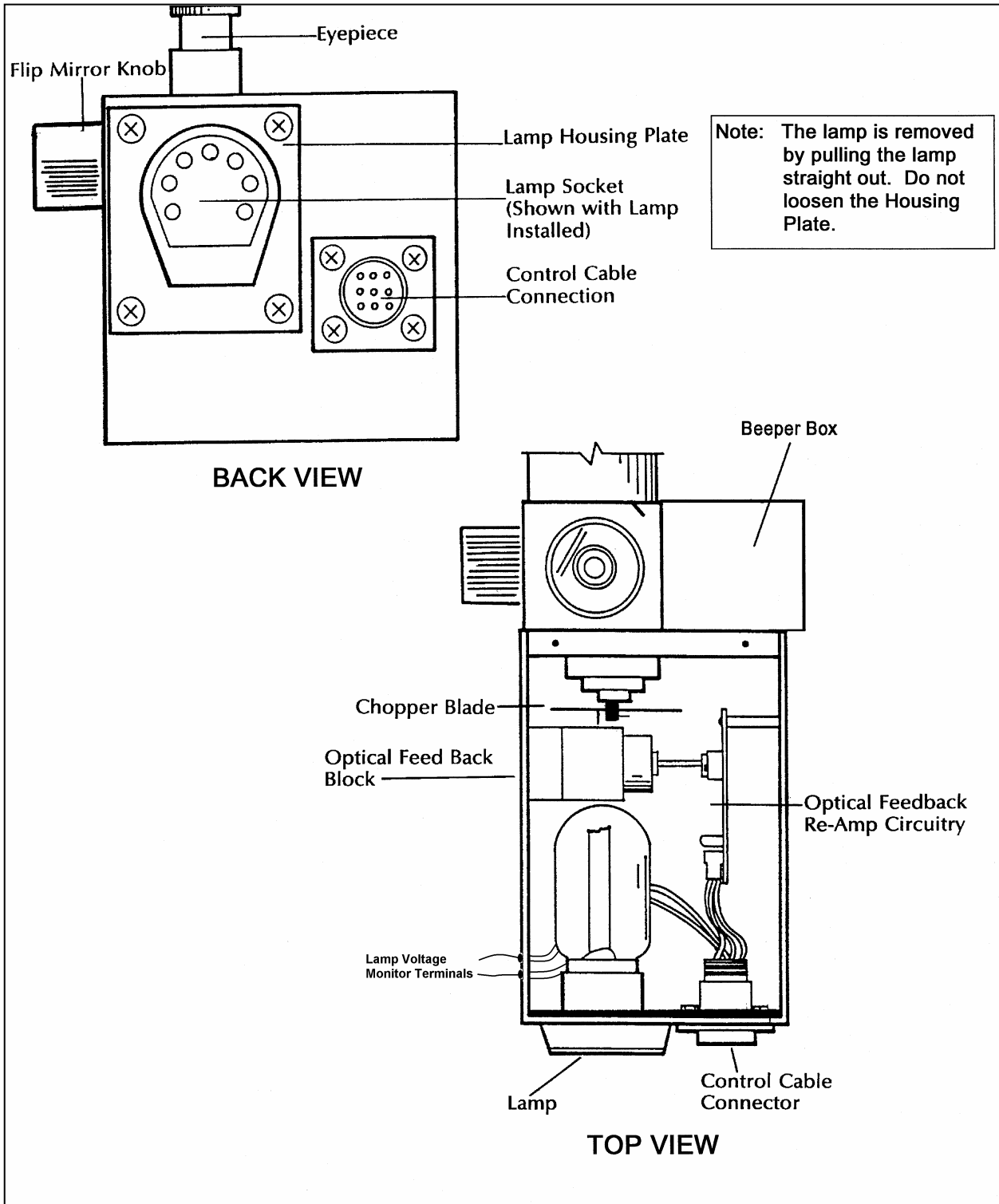

Figure 4-2. Transmitter Lamp Housing.

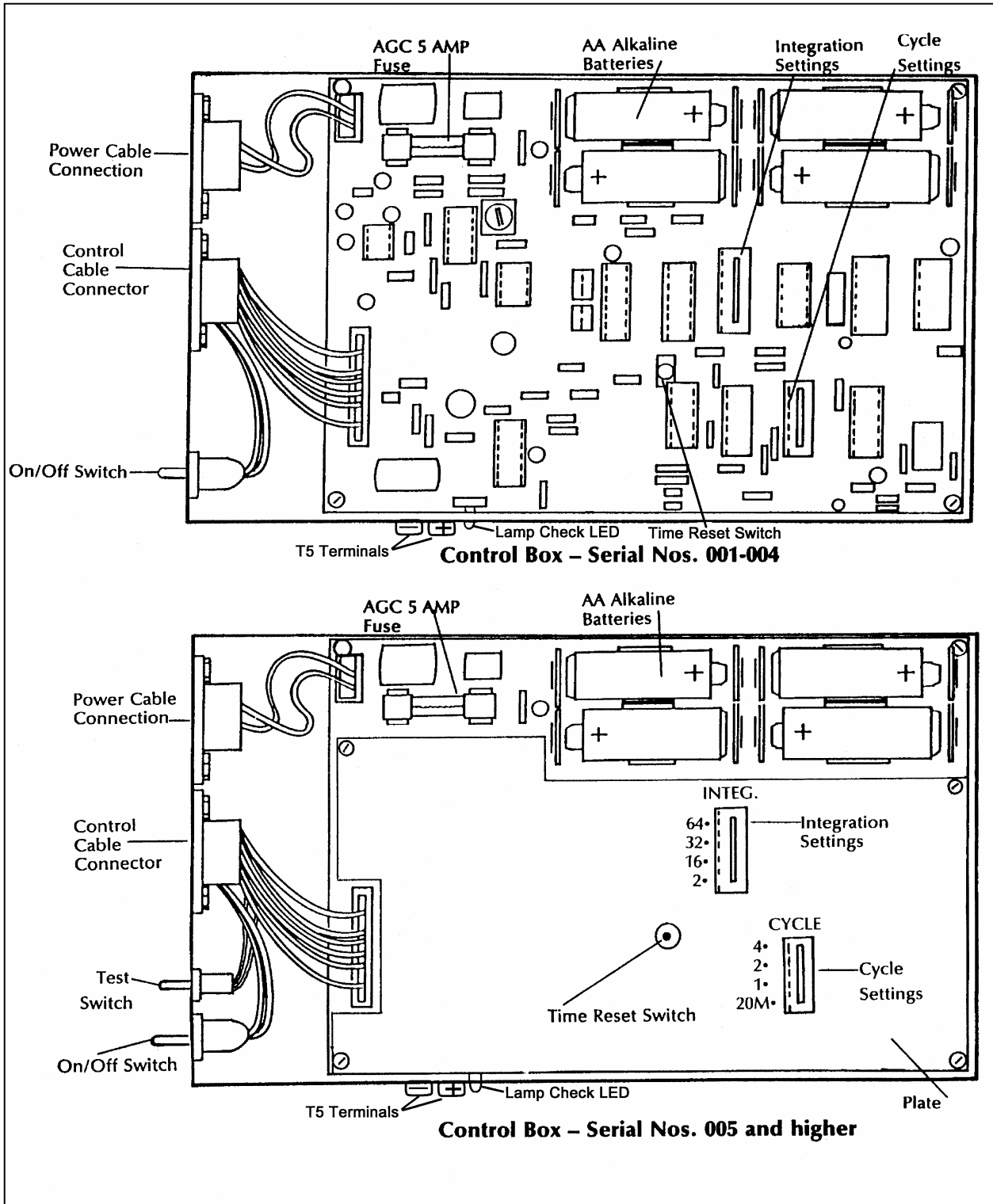

Figure 4-3. Transmitter Control Box Diagram (LPV-2 only).

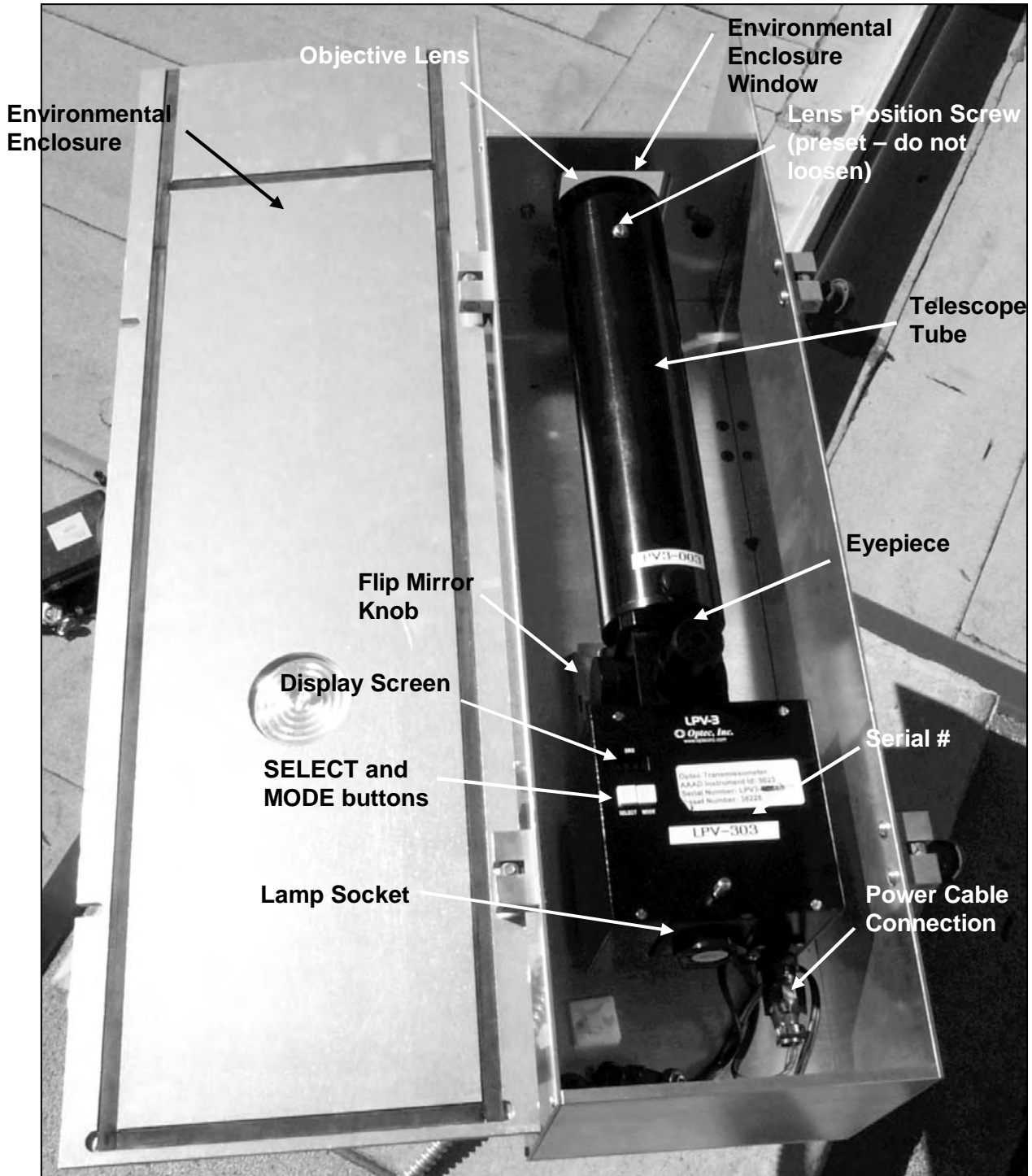

Figure 4-4. LPV-3 Transmitter Components.

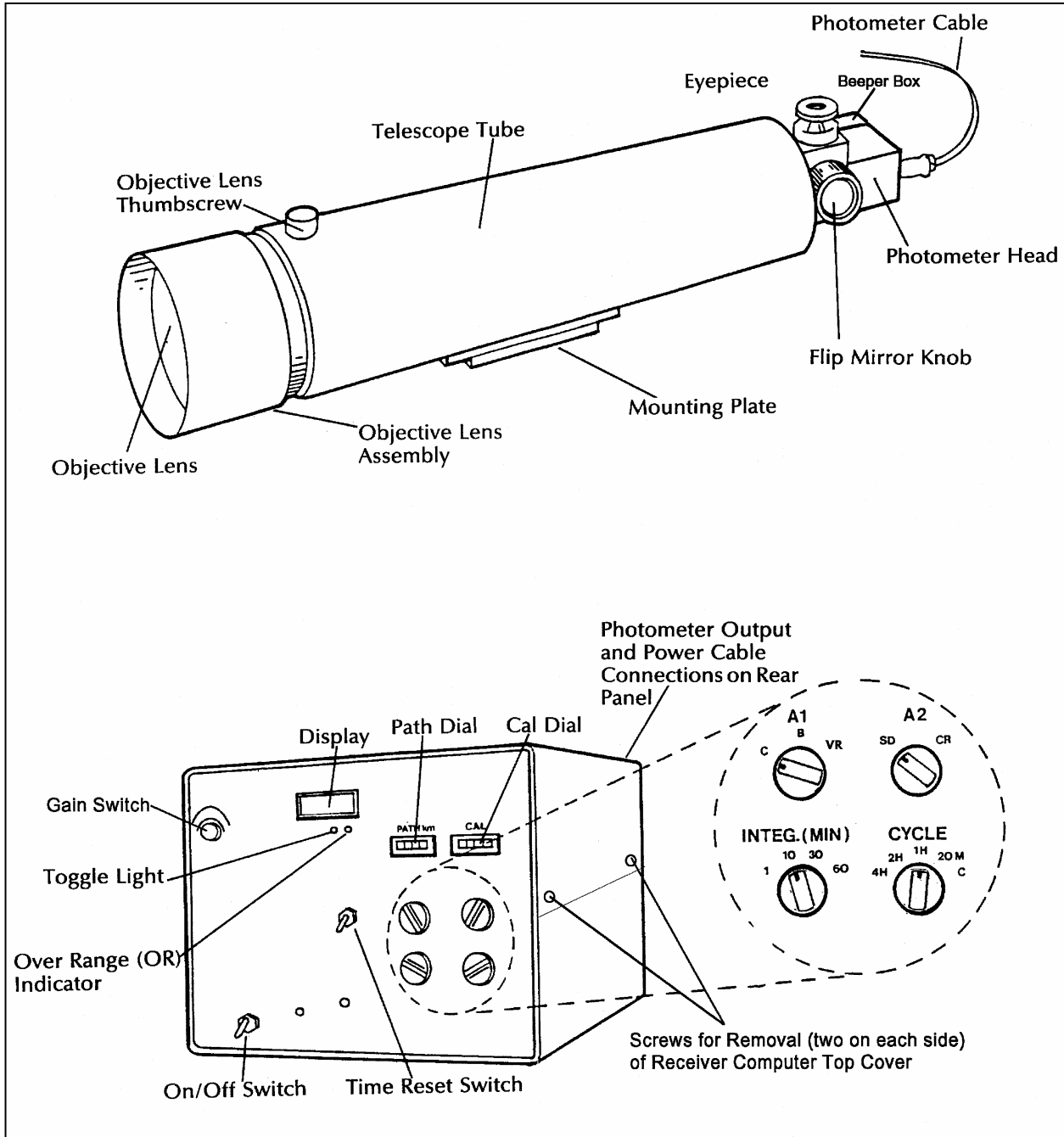

Figure 4-5. Receiver Component Diagram.

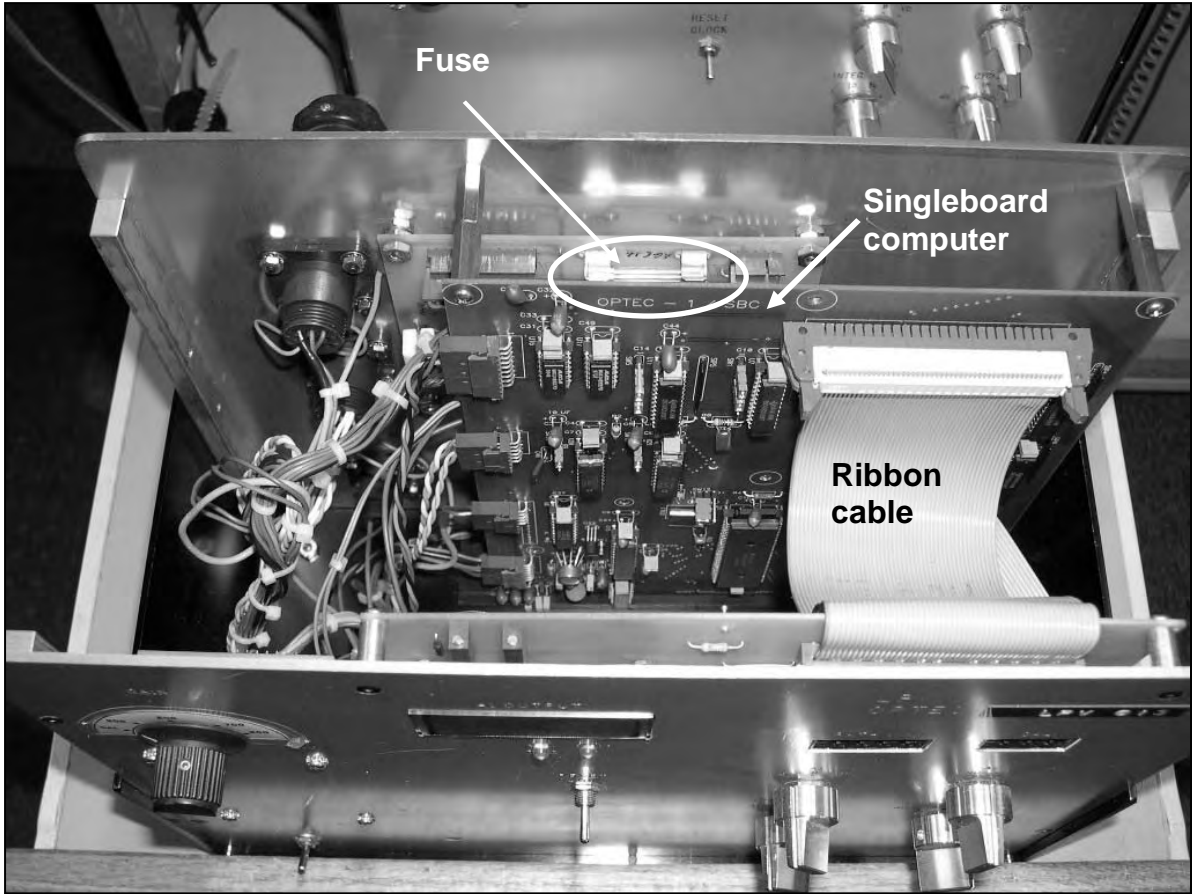

Figure 4-6. Receiver Computer Cards and Fuse Diagram.

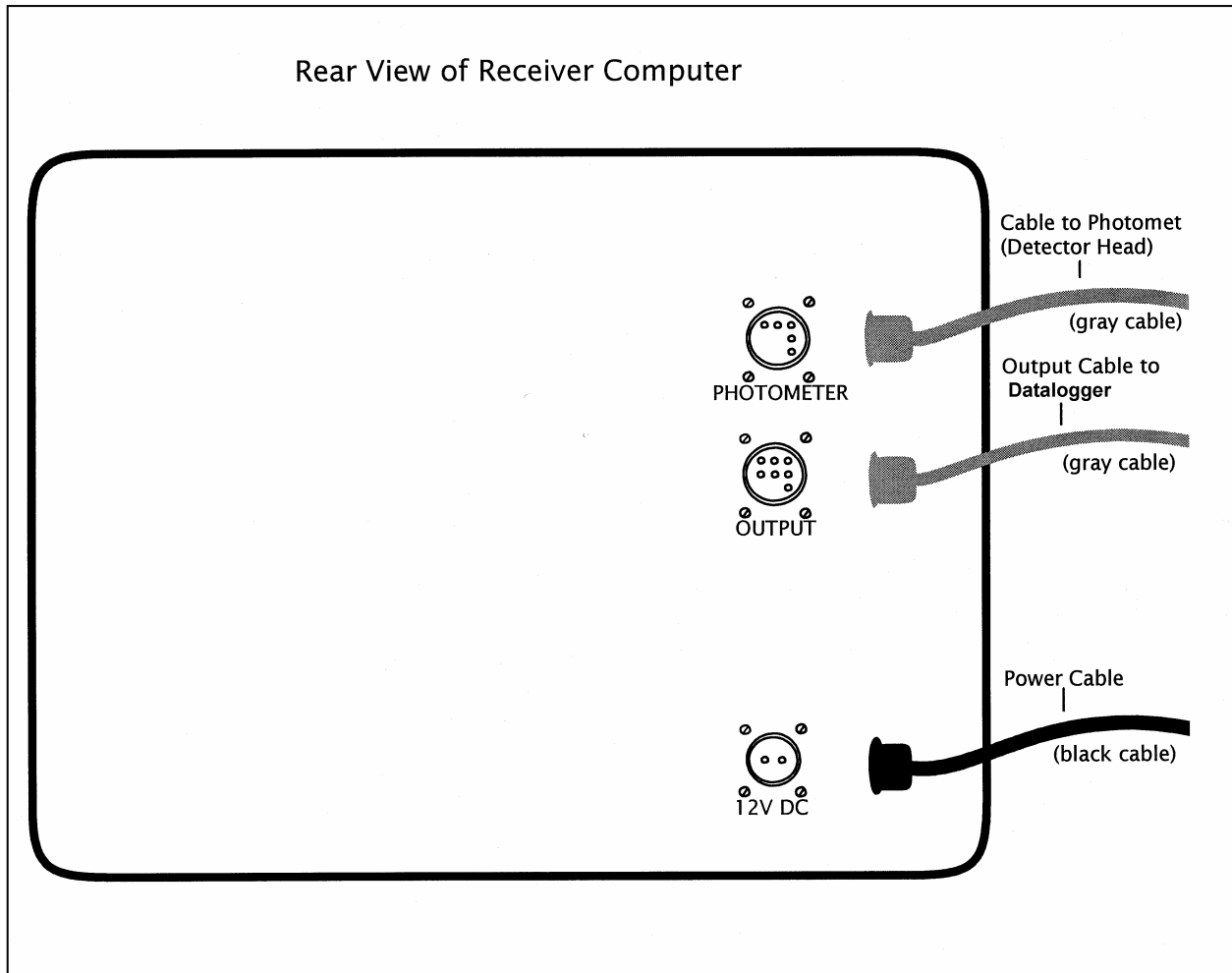
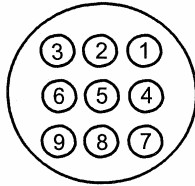

Figure 4-7. Receiver Computer Cable Connections Diagram.

Receiver Computer

Output Connector



<i>Pin No.</i>	<i>Function</i>	<i>Wire Color</i>
1	A1 Switchable to: Raw Reading, B _{ext} , or VR	Yellow
2	A2 Switchable to: Raw Reading, Std. Deviation	White
3	Toggle Switch	Orange
4	A1 Ground	Green
5	A2 Ground	Black
6	Toggle Ground	Brown
7	Not Used	
8	Not Used	
9		Bare

Power Connector

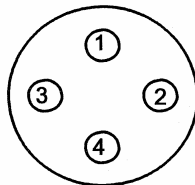

<i>Pin No.</i>	<i>Function</i>	<i>Wire Color</i>
1	Not Used	
2	+12 Volt DC	Black (Ribbed)
3	Ground	Black
4	Not Used	

Figure 4-8. Receiver Computer Output and Power Connector Description.

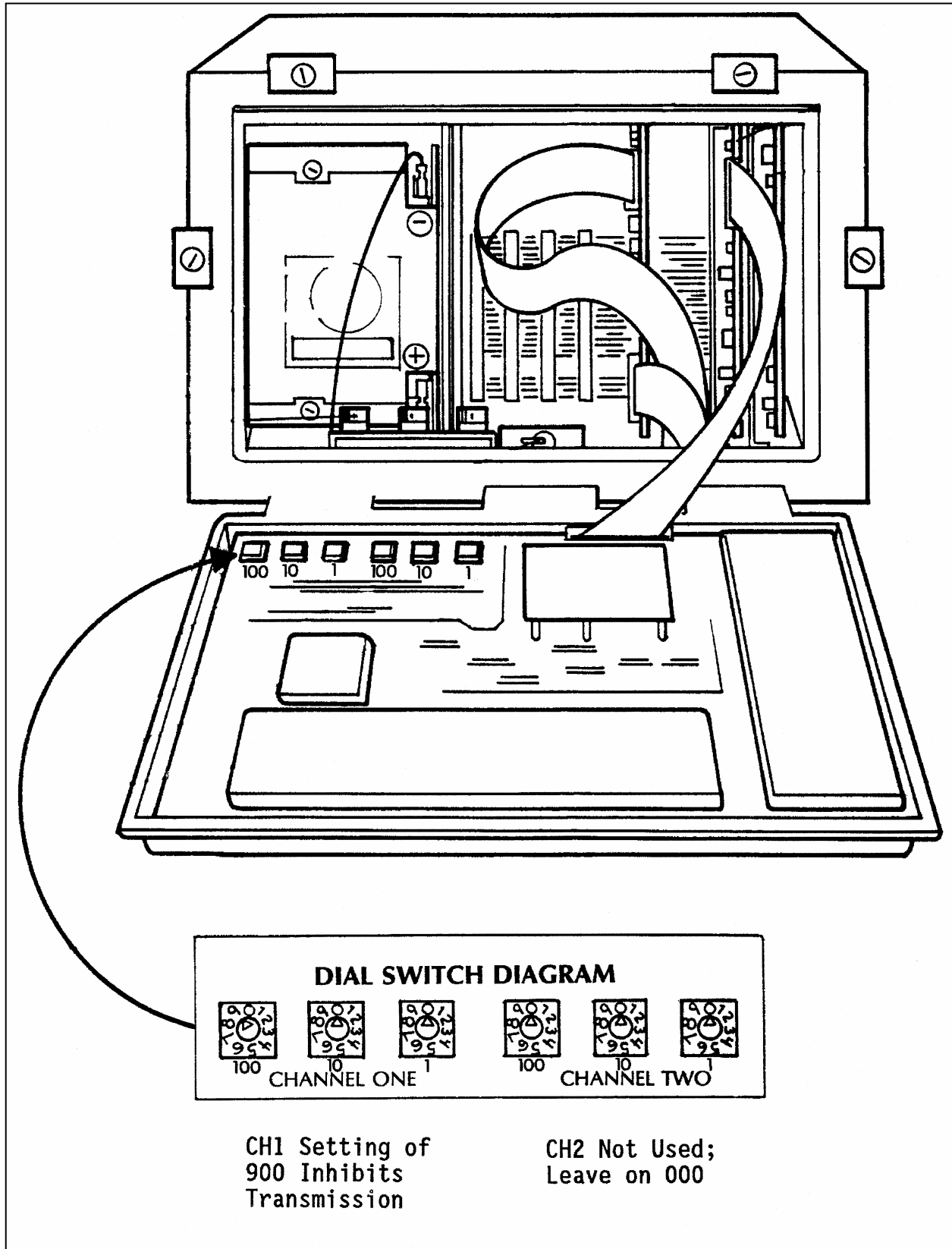

Figure 4-9. DCP Transmission Channel Switches Diagram.

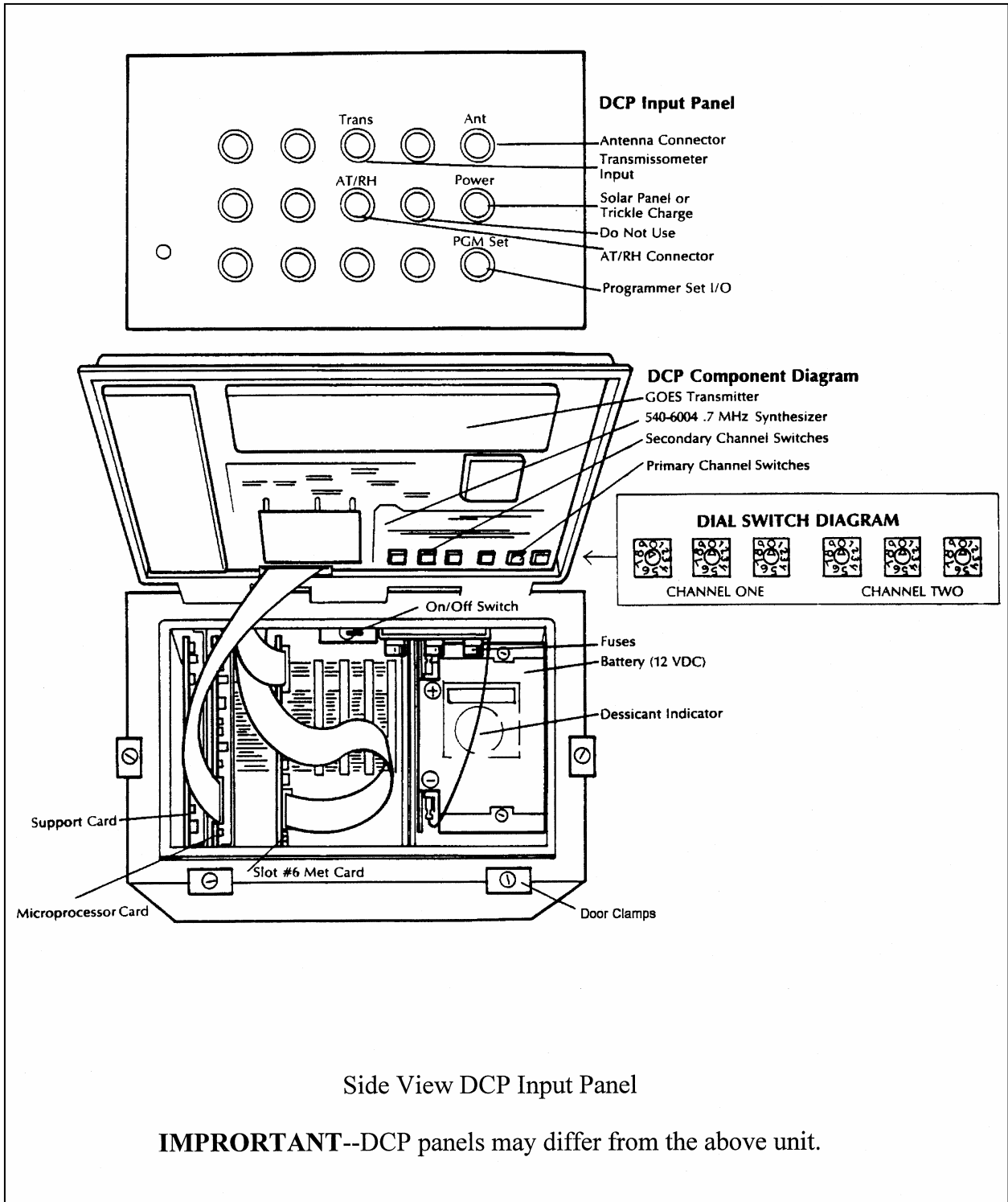

Figure 4-10. DCP Component Diagram.

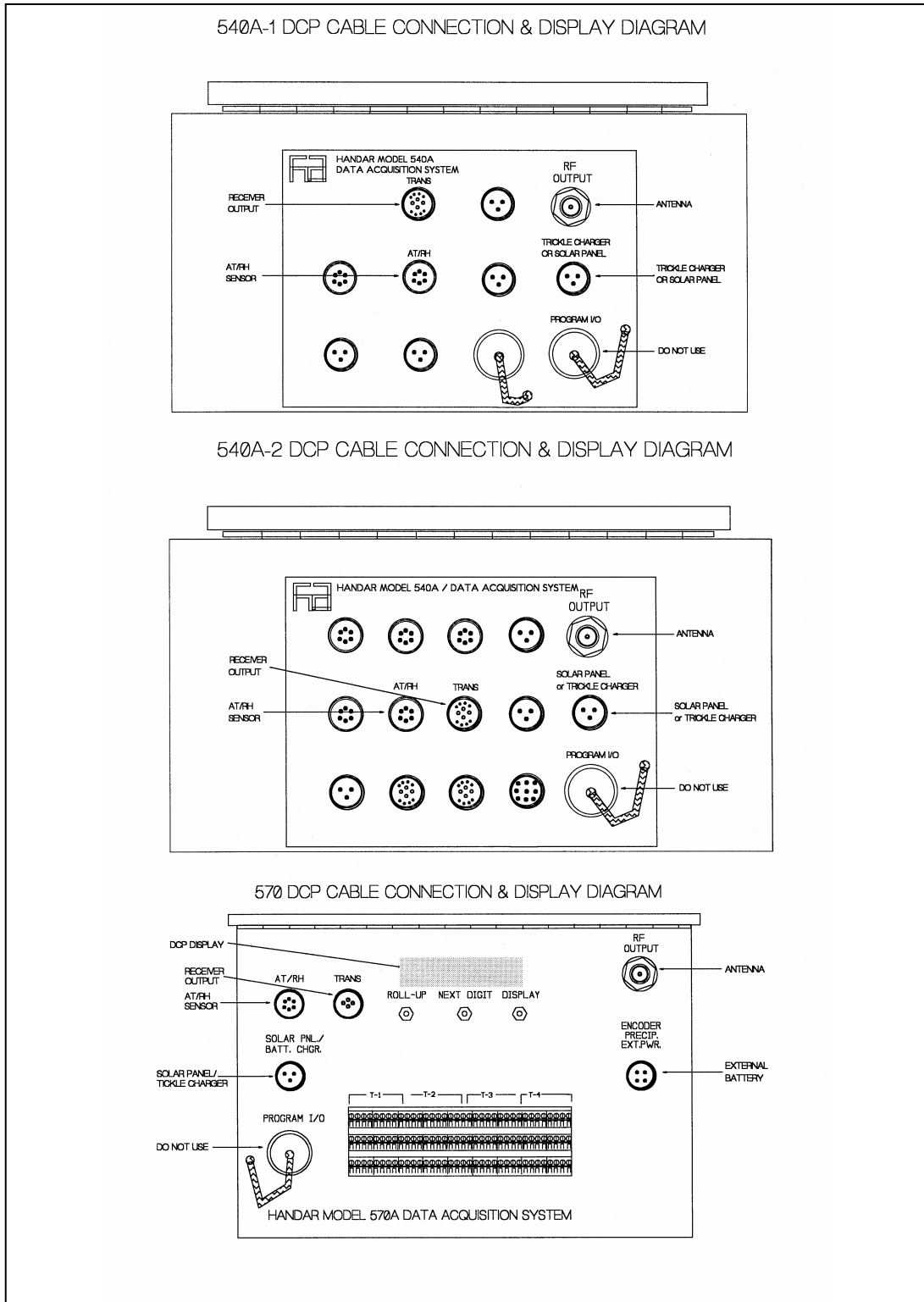

Figure 4-11. DCP Cable Connection and Display Diagram.

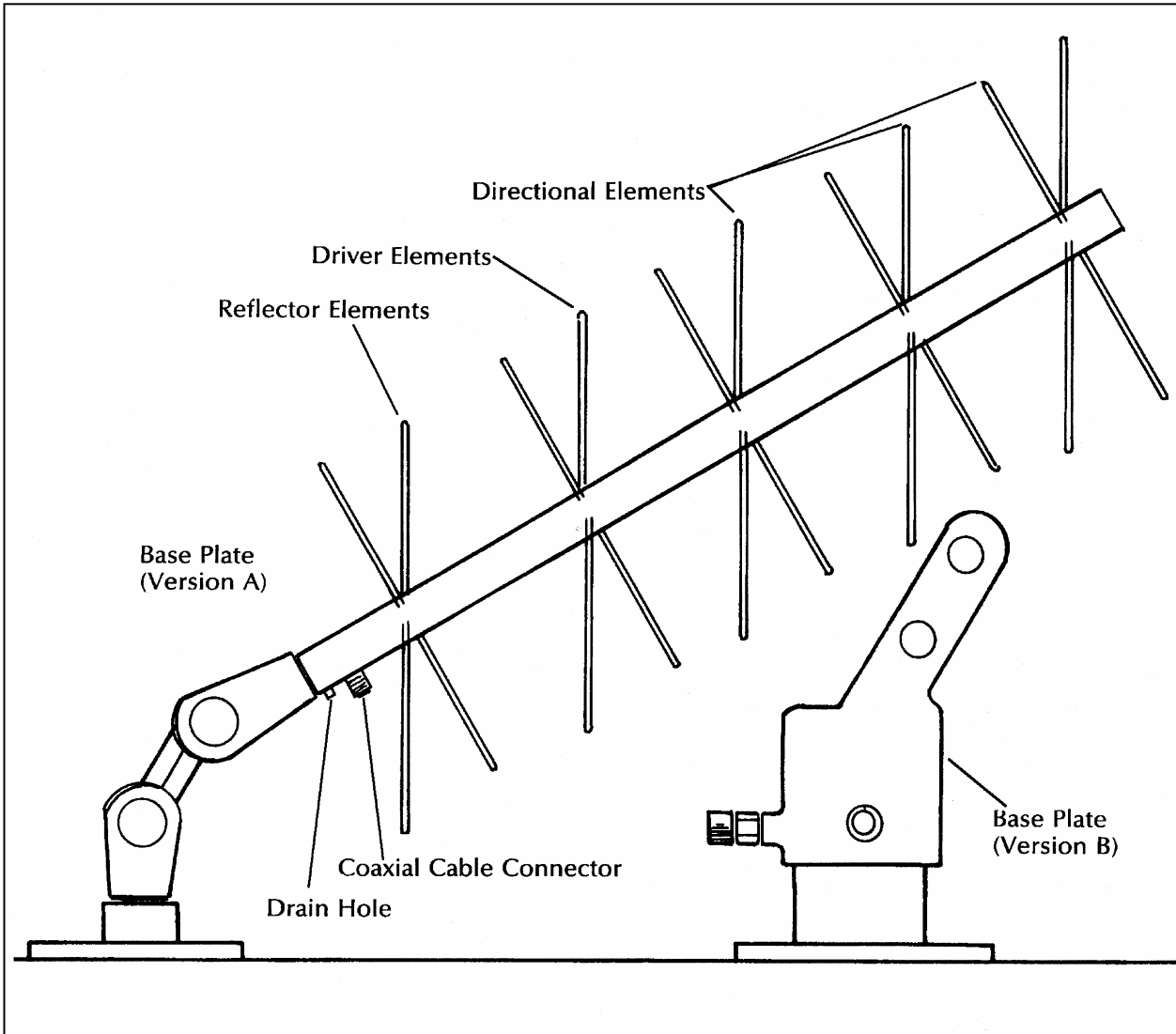

Figure 4-12. DCP Antenna Component Diagram.

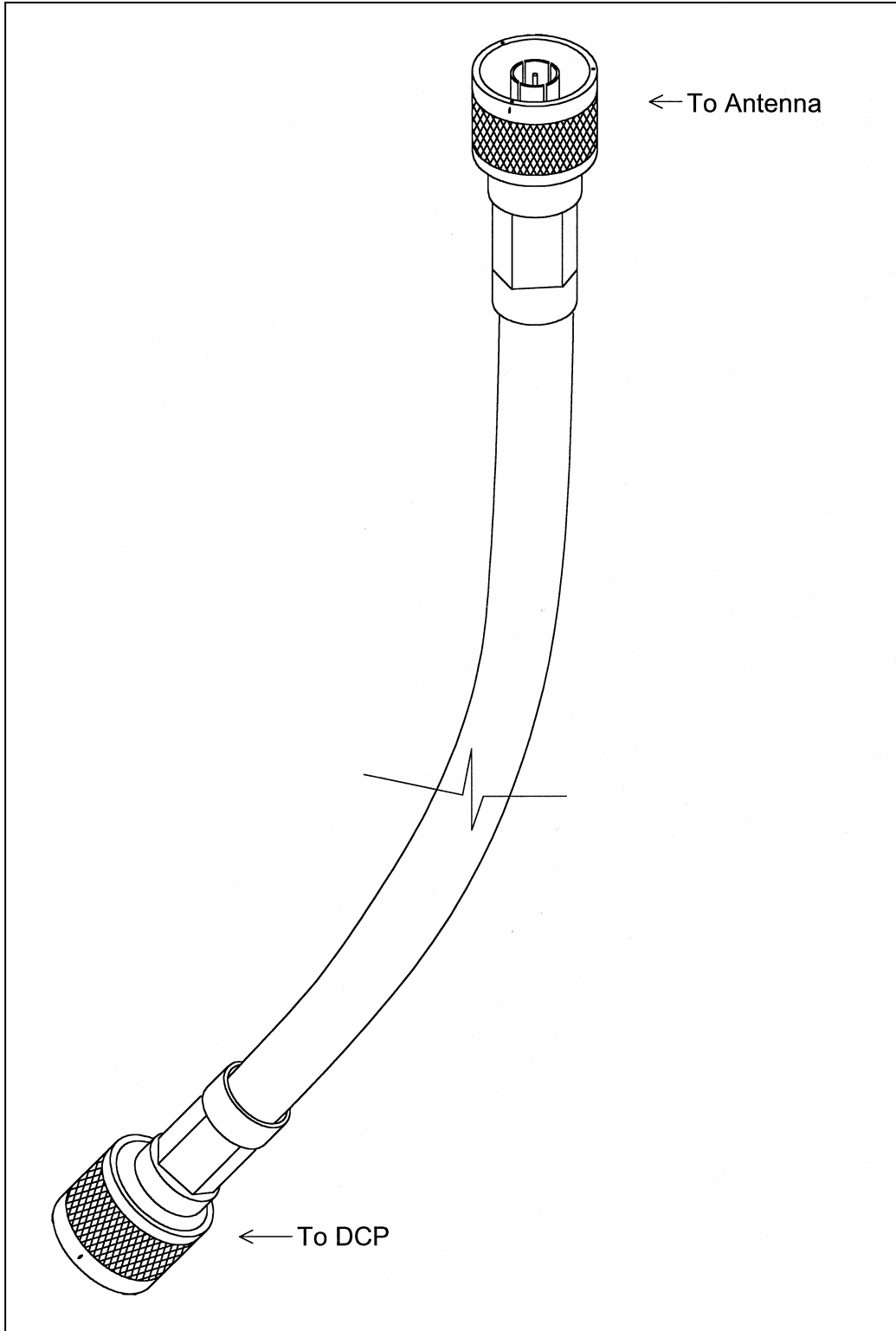

Figure 4-13. DCP Antenna Cable Connection Diagram.

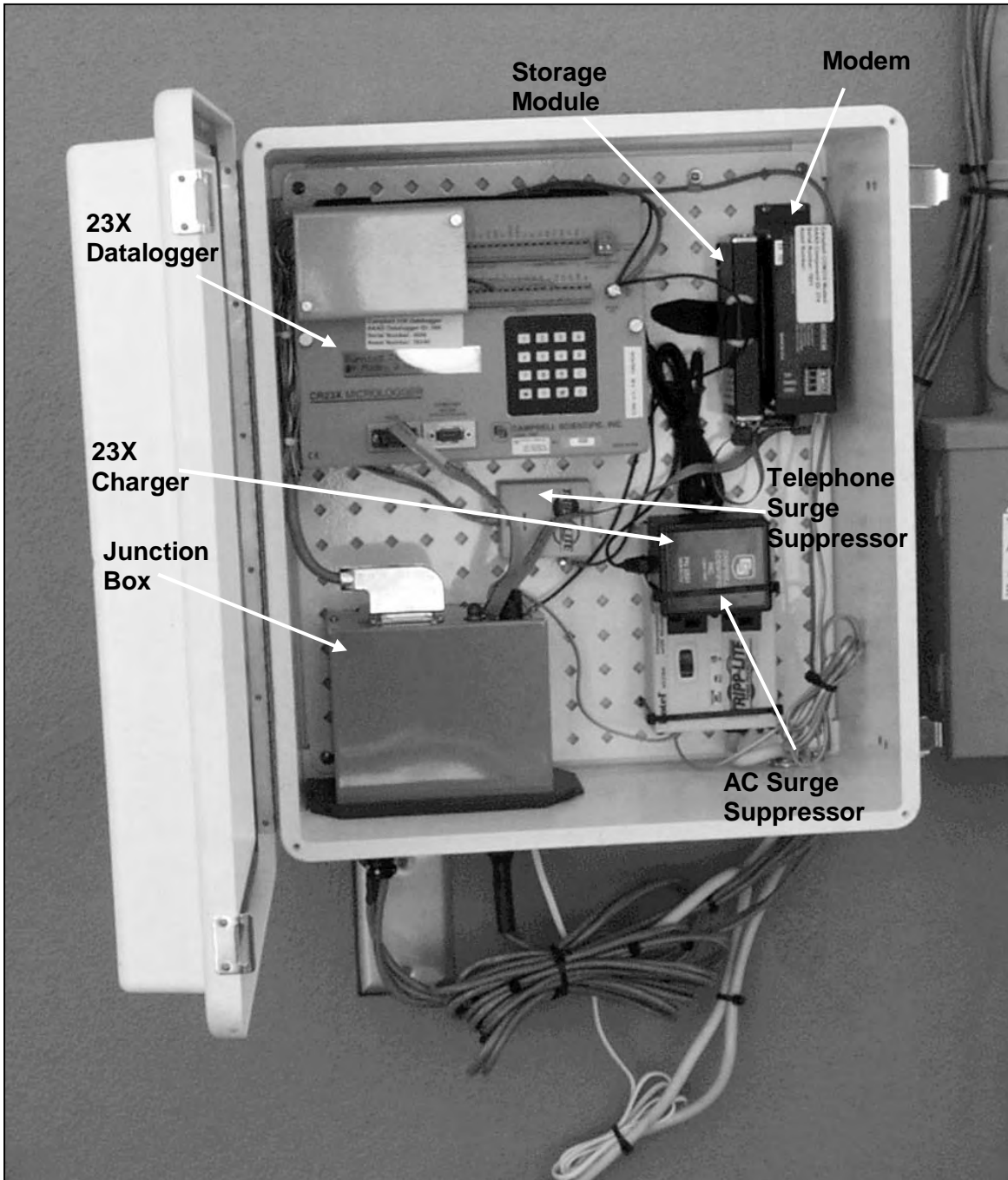

Figure 4-14. 23X Enclosure Components.

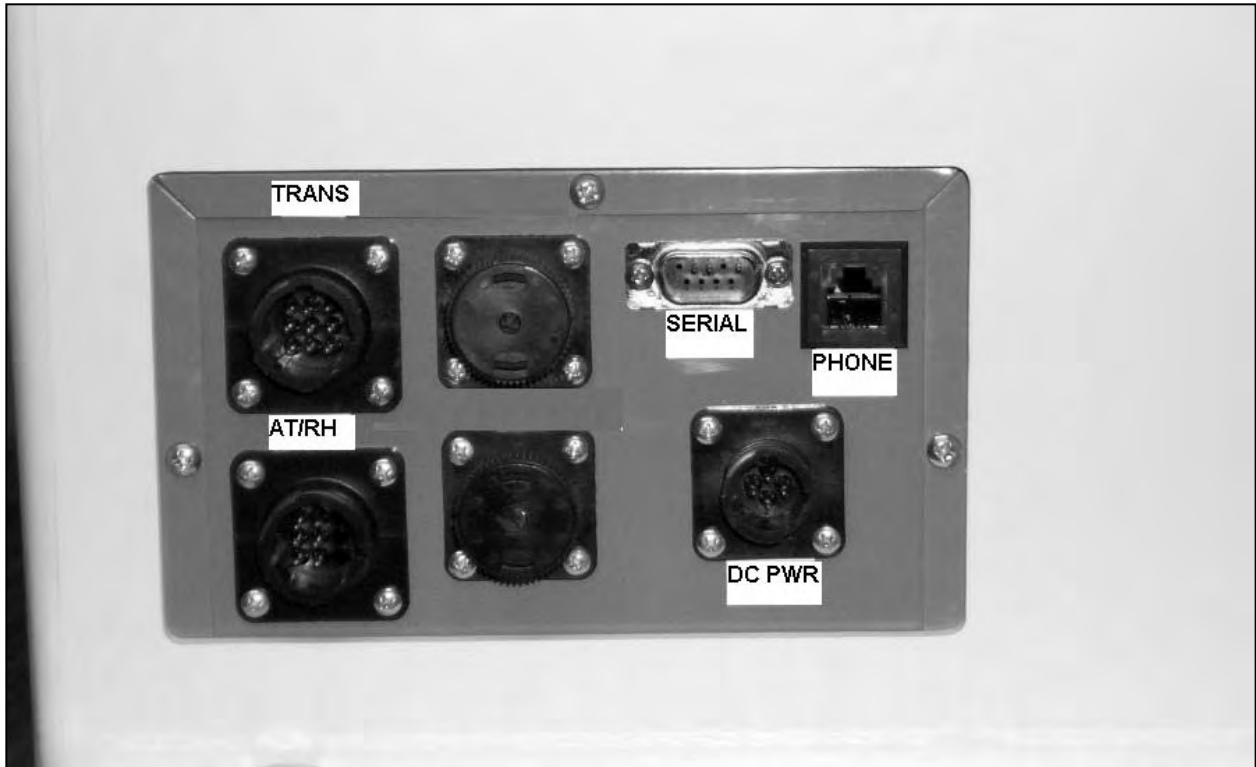

Figure 4-15. 23X Enclosure Connector Panel.

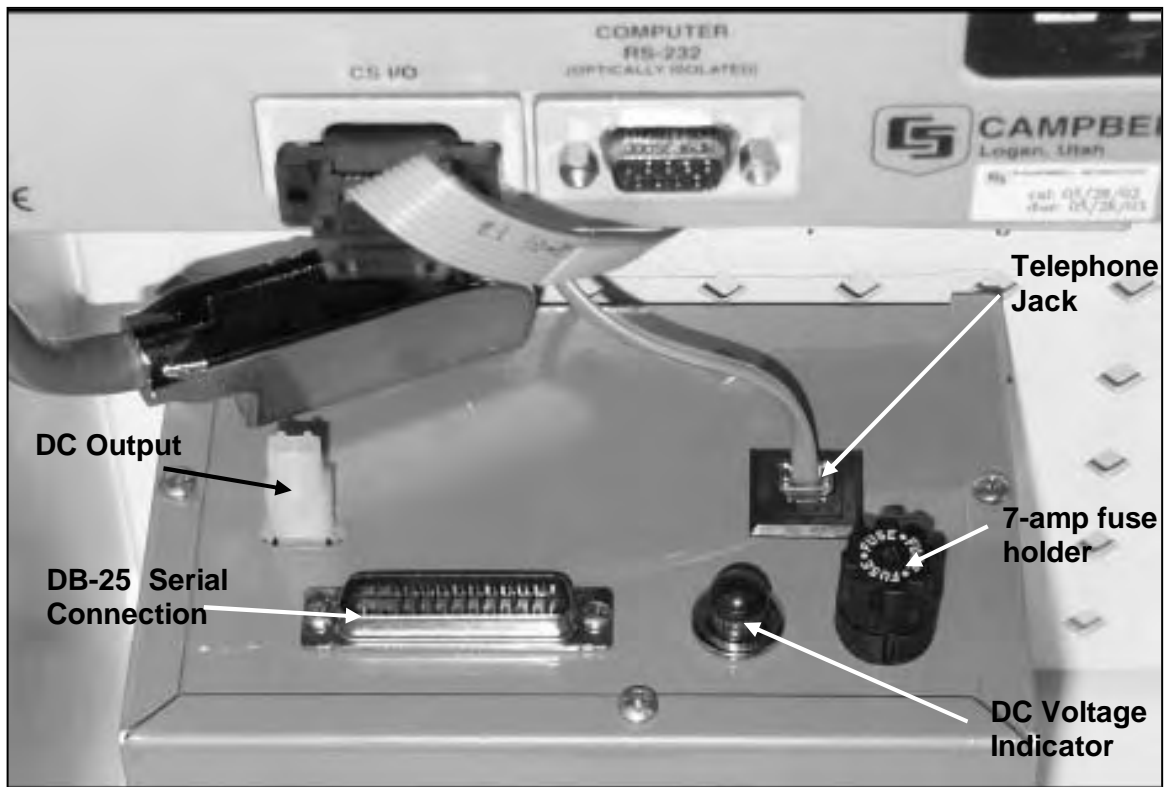

Figure 4-16. Junction Box Connector Panel.

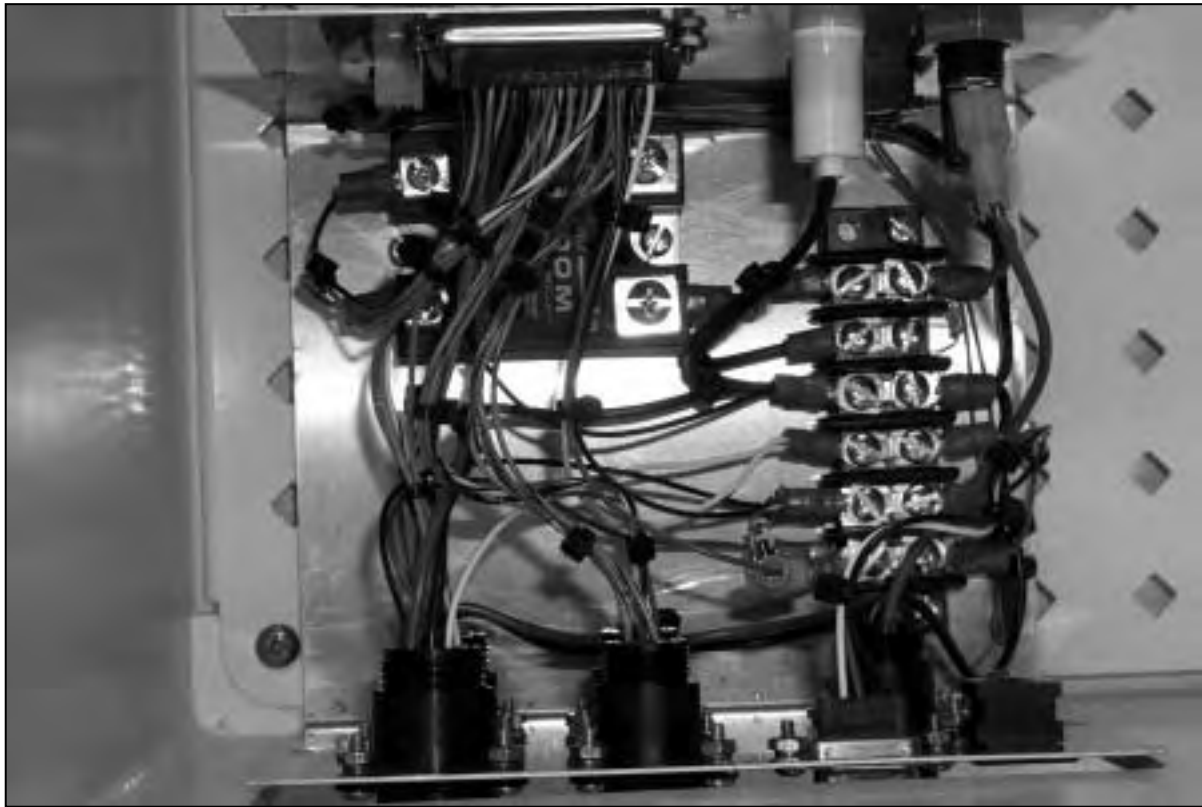

Figure 4-17. Internal Wiring of Junction Box.

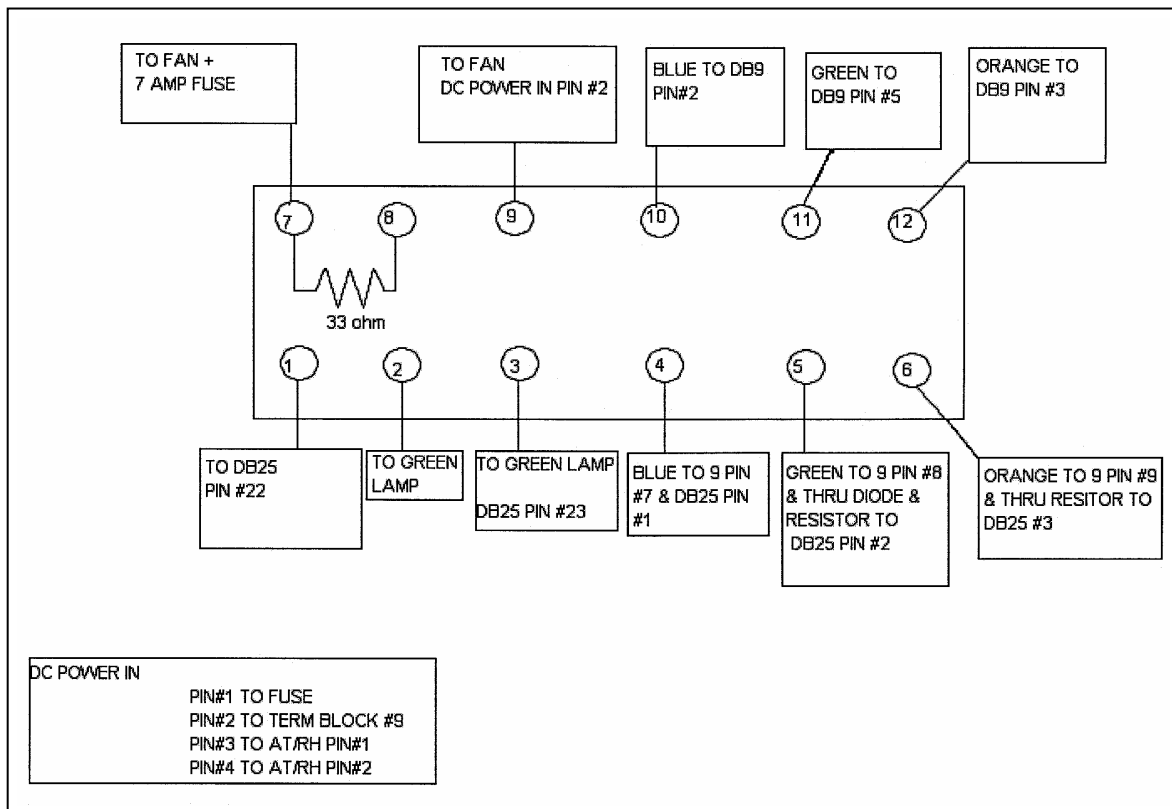

Figure 4-18. Schematic of Internal Wiring of Junction Box.

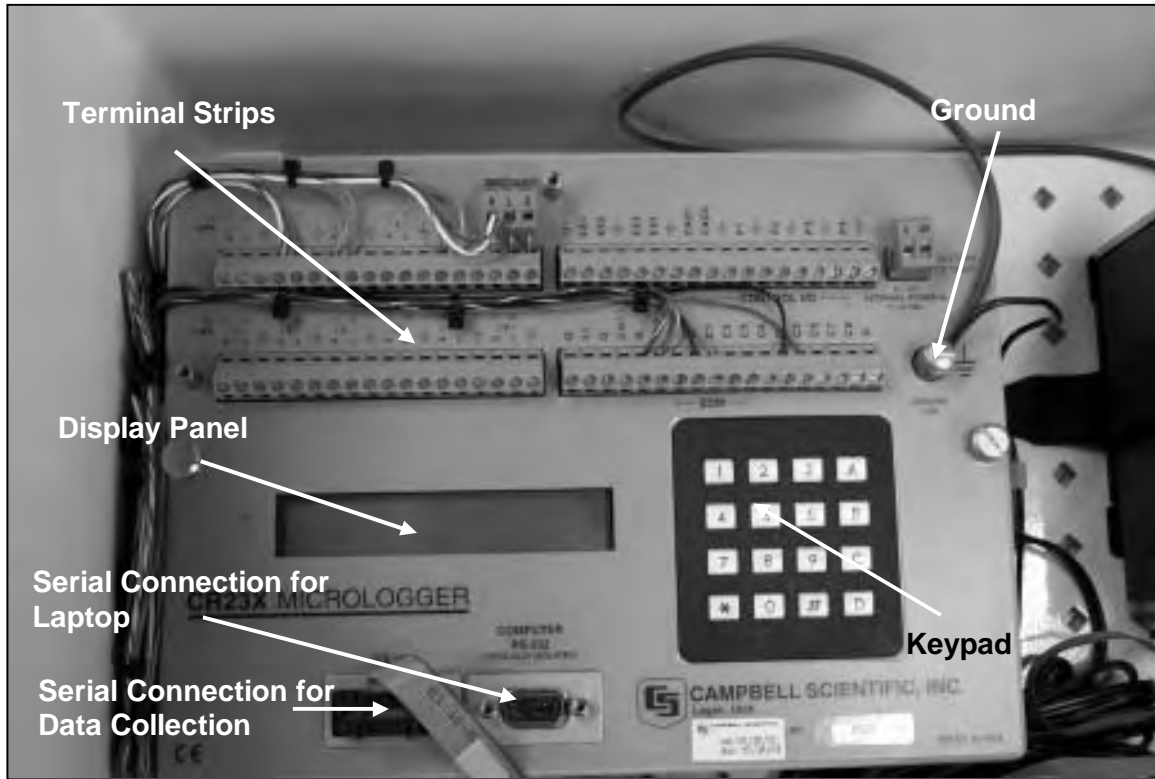

Figure 4-19. Campbell Scientific 23X Datalogger.

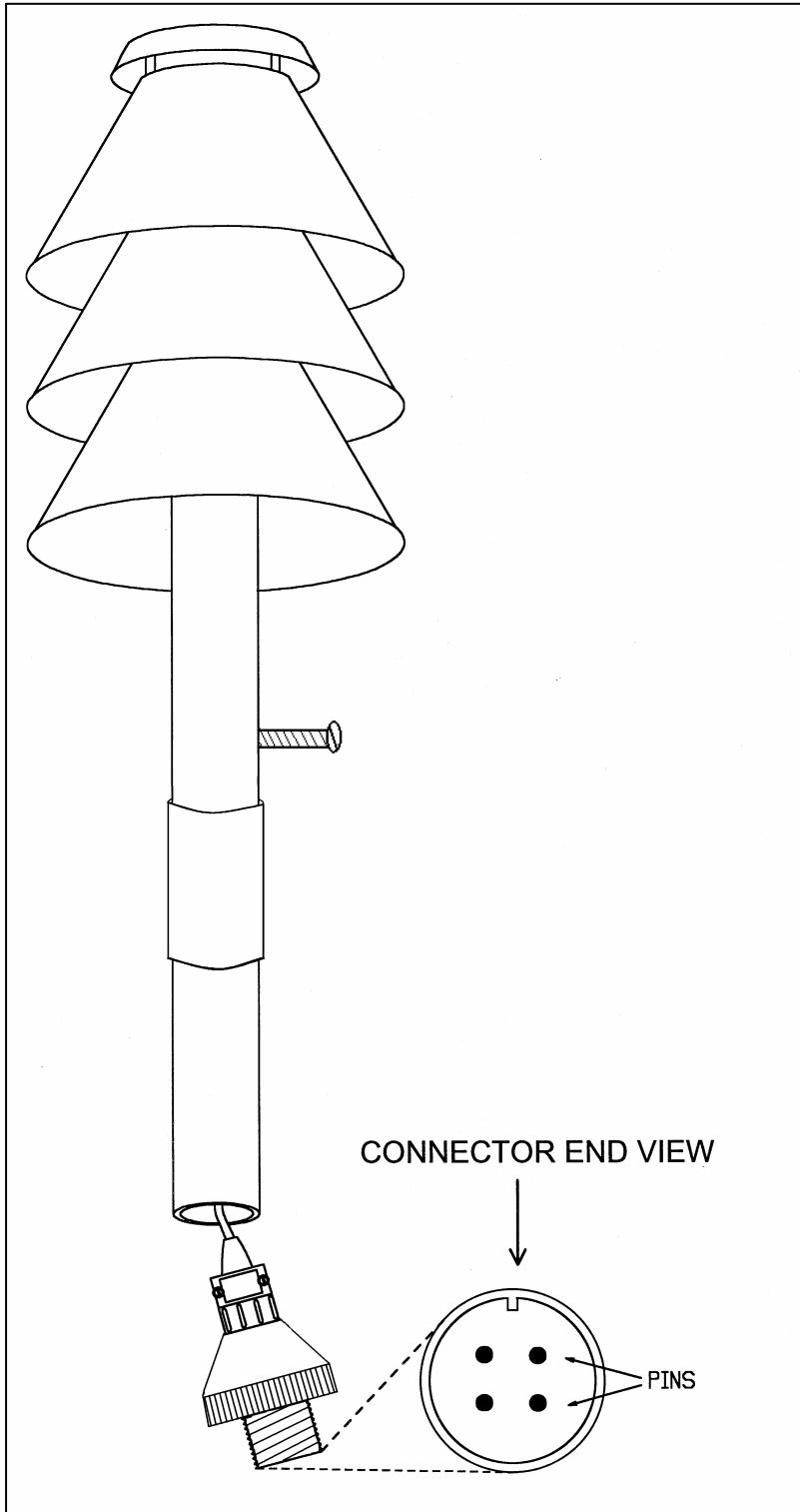

Figure 4-20. AT/RH Sensor and Cable Diagram.

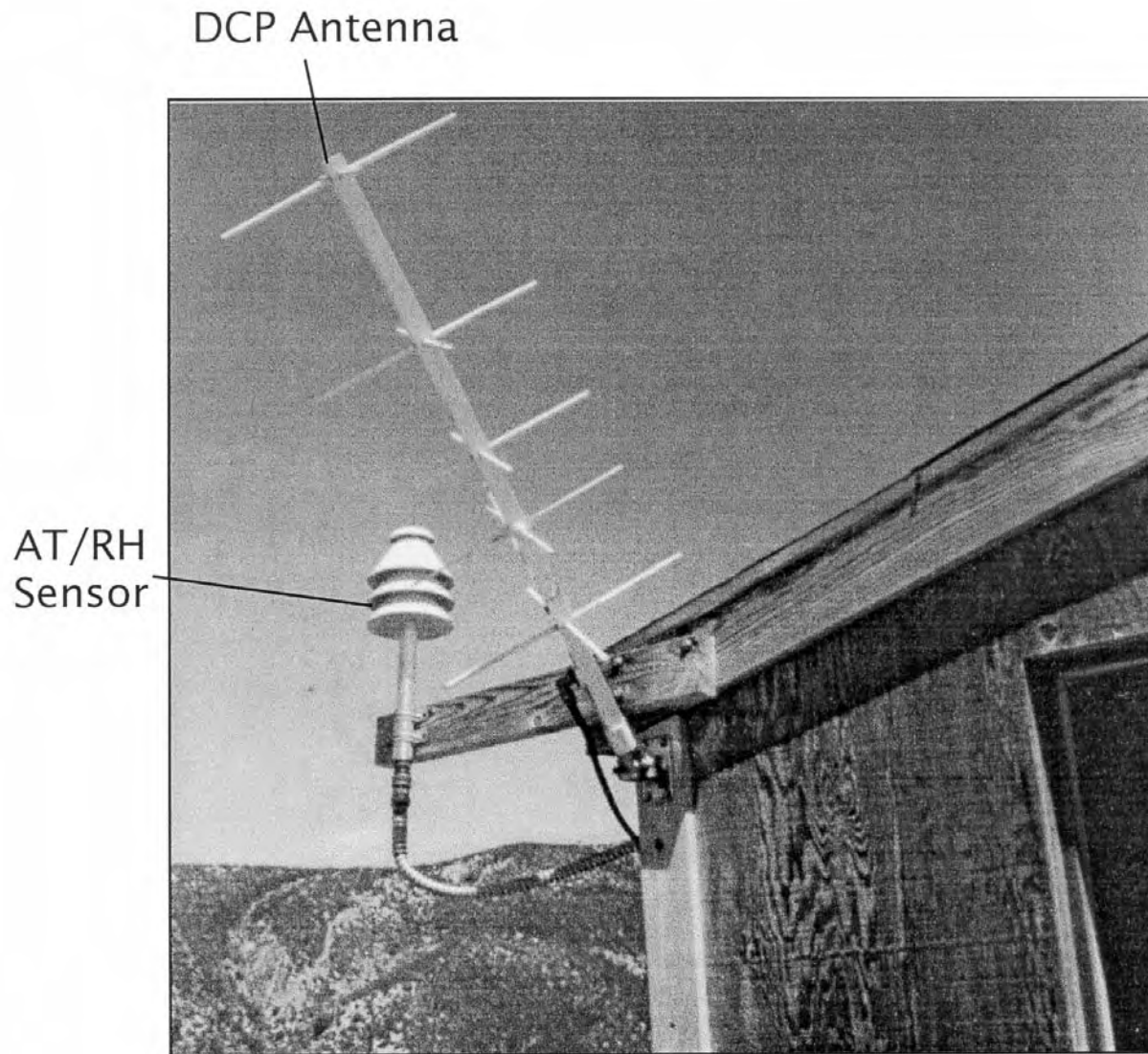

Figure 4-21. Mounted AT/RH Sensor and DCP Antenna.

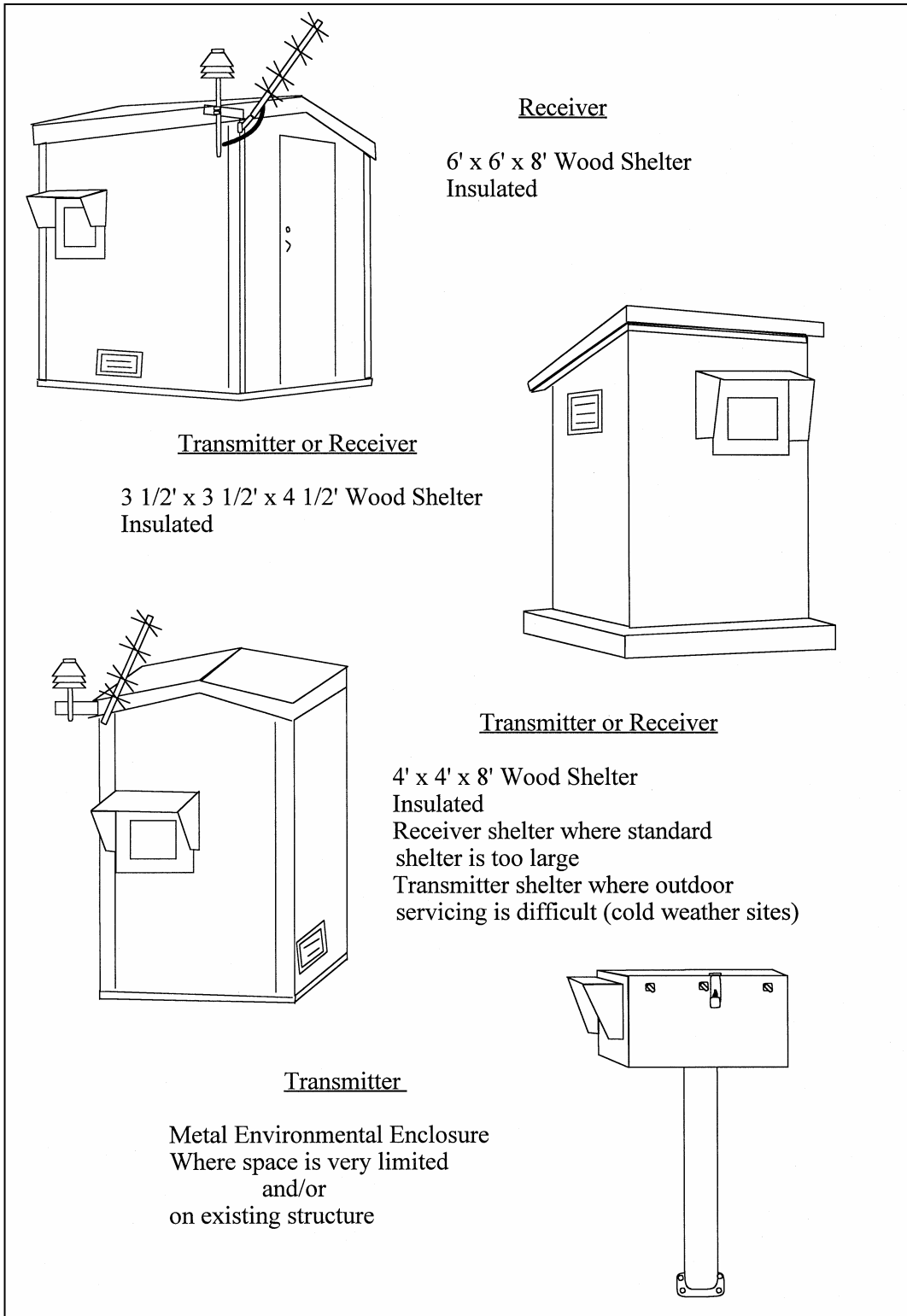
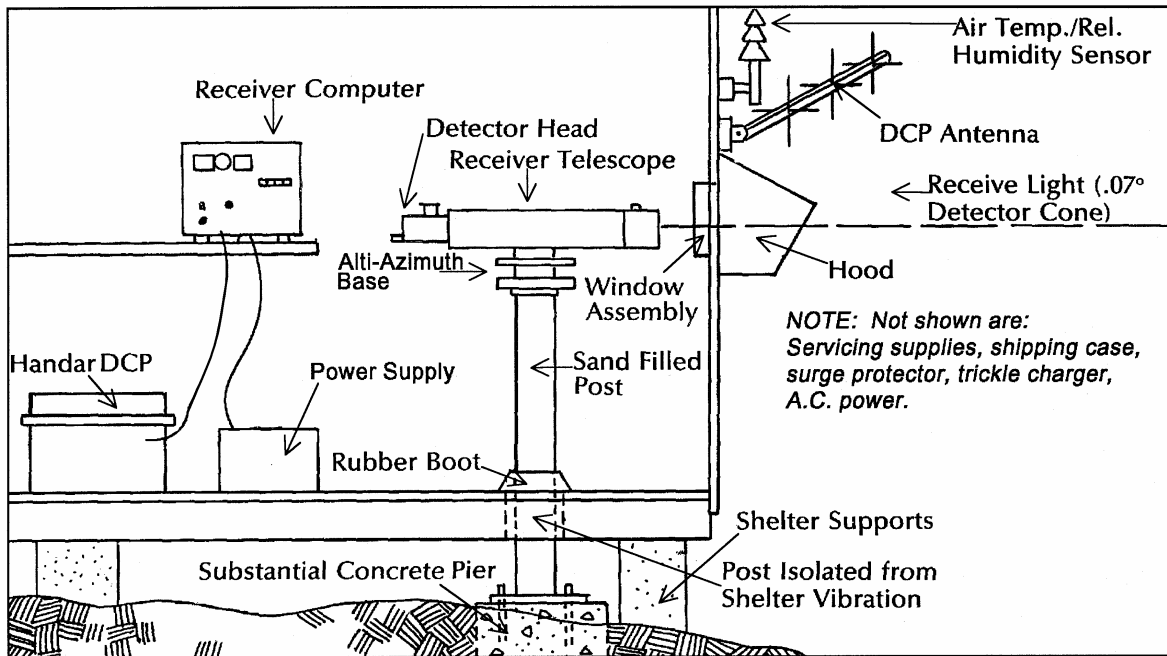

Figure 4-22. Transmissometer System Shelters Diagram.

Receiver Station
 (6'x 6'x 8')



Transmitter Station
 (3'x3'x4'6")

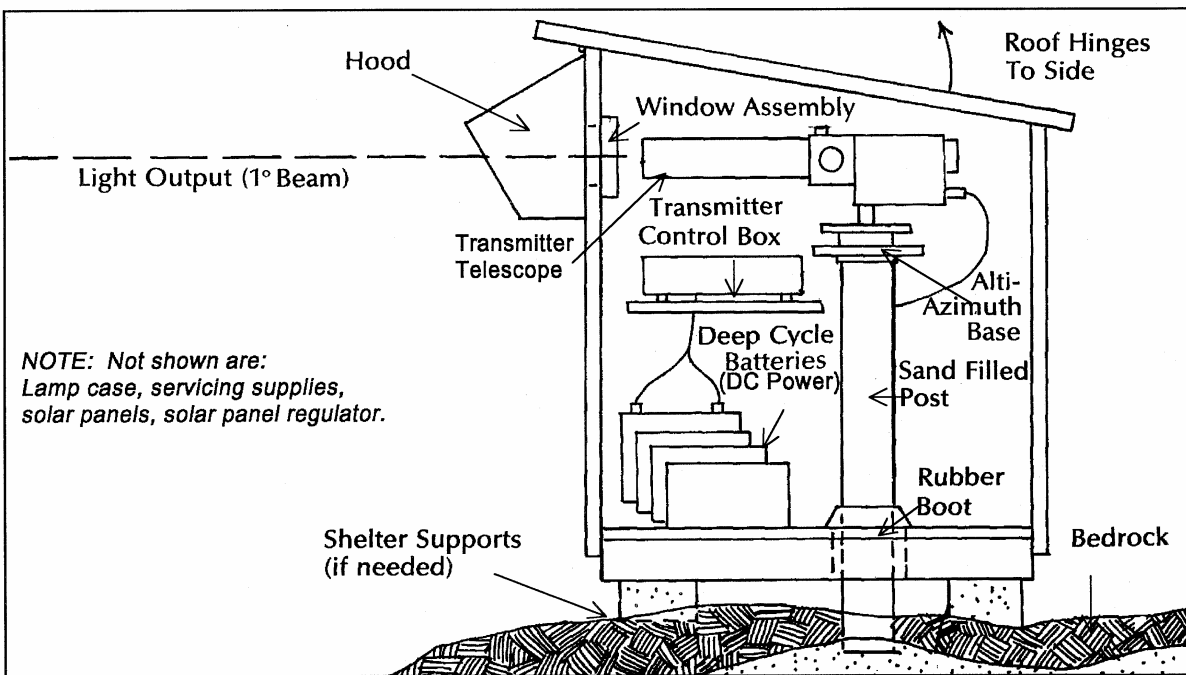
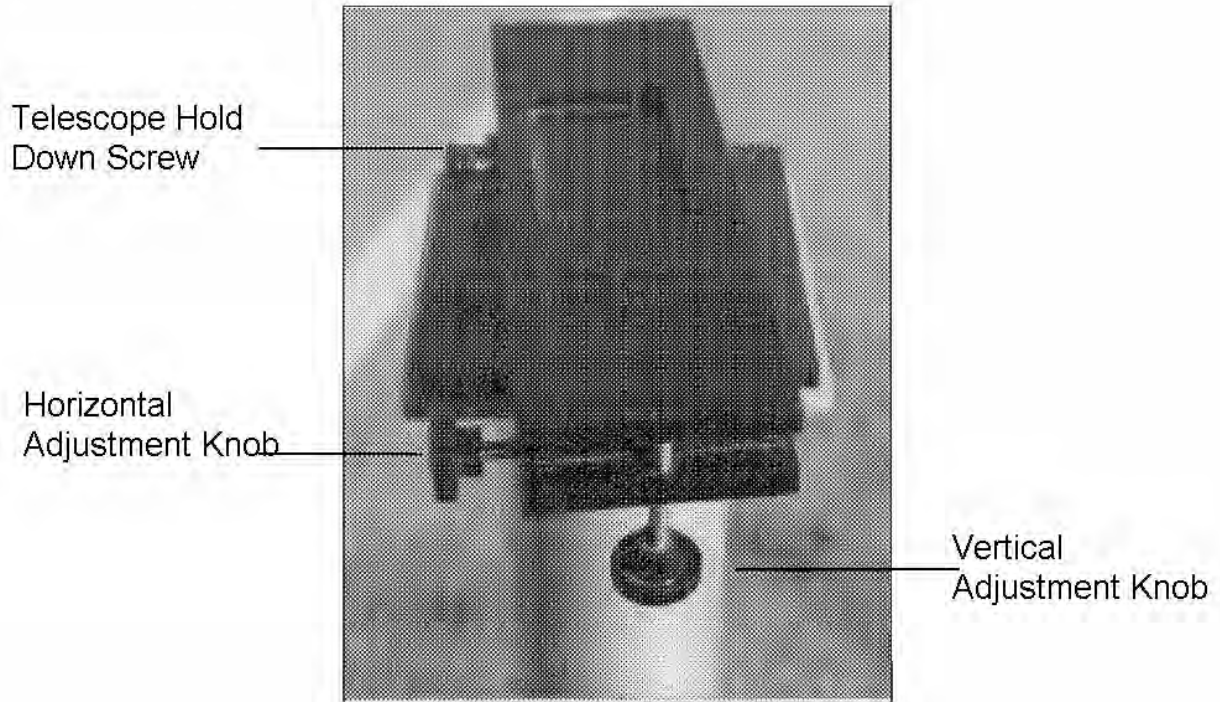
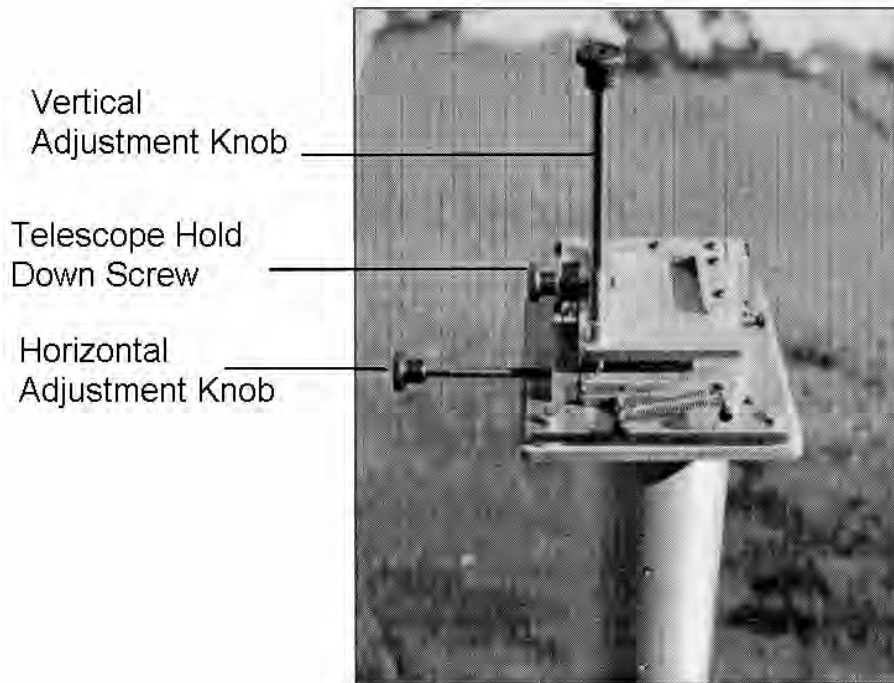

Figure 4-23. Monitoring Component Diagram (Receiver and Transmitter Shelters).



Receiver Alti-Azimuth Base



Transmitter Alti-Azimuth Base

Figure 4-24. Receiver and Transmitter Alti-Azimuth Bases.

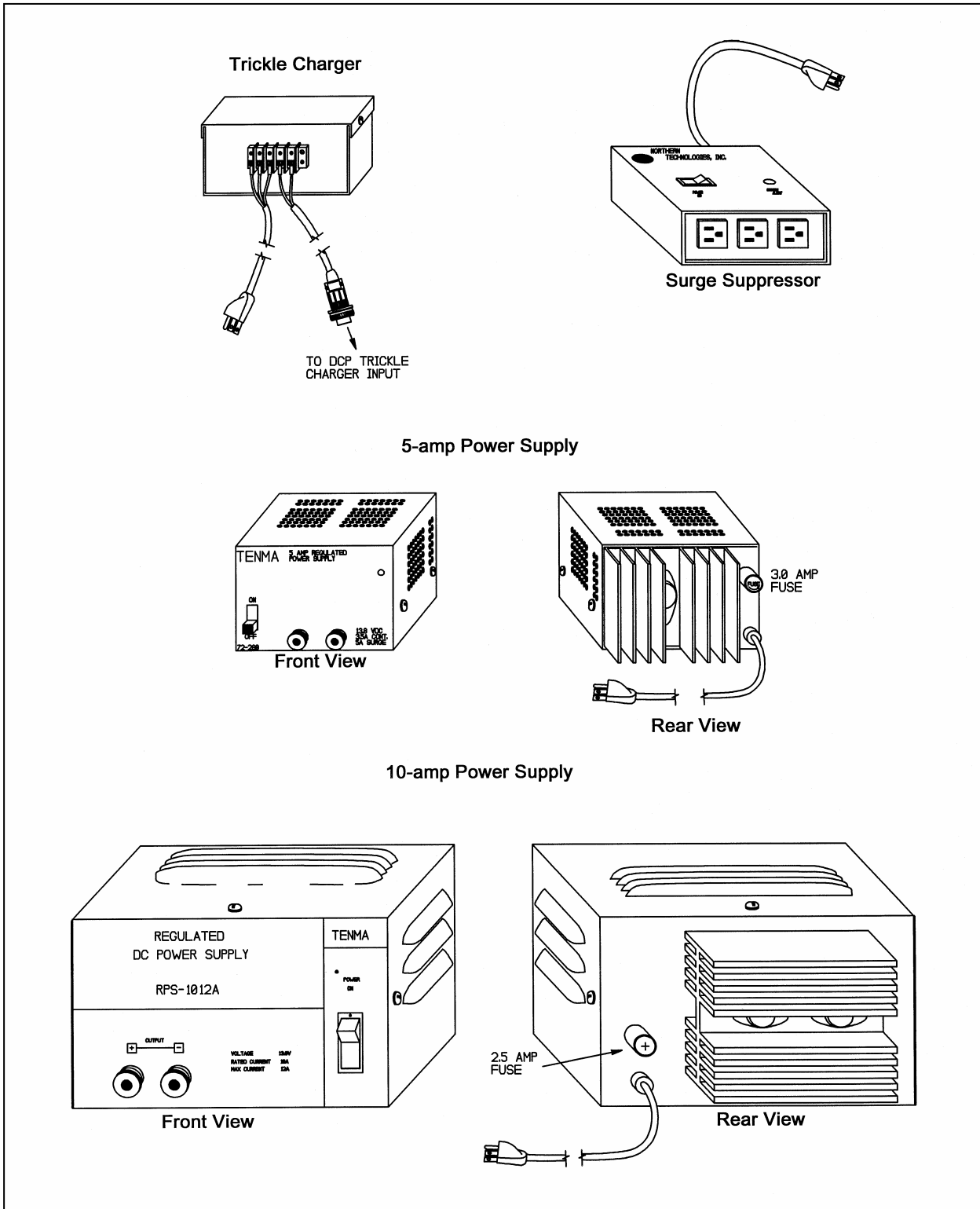

Figure 4-25. Line Power (AC) Components Diagram.

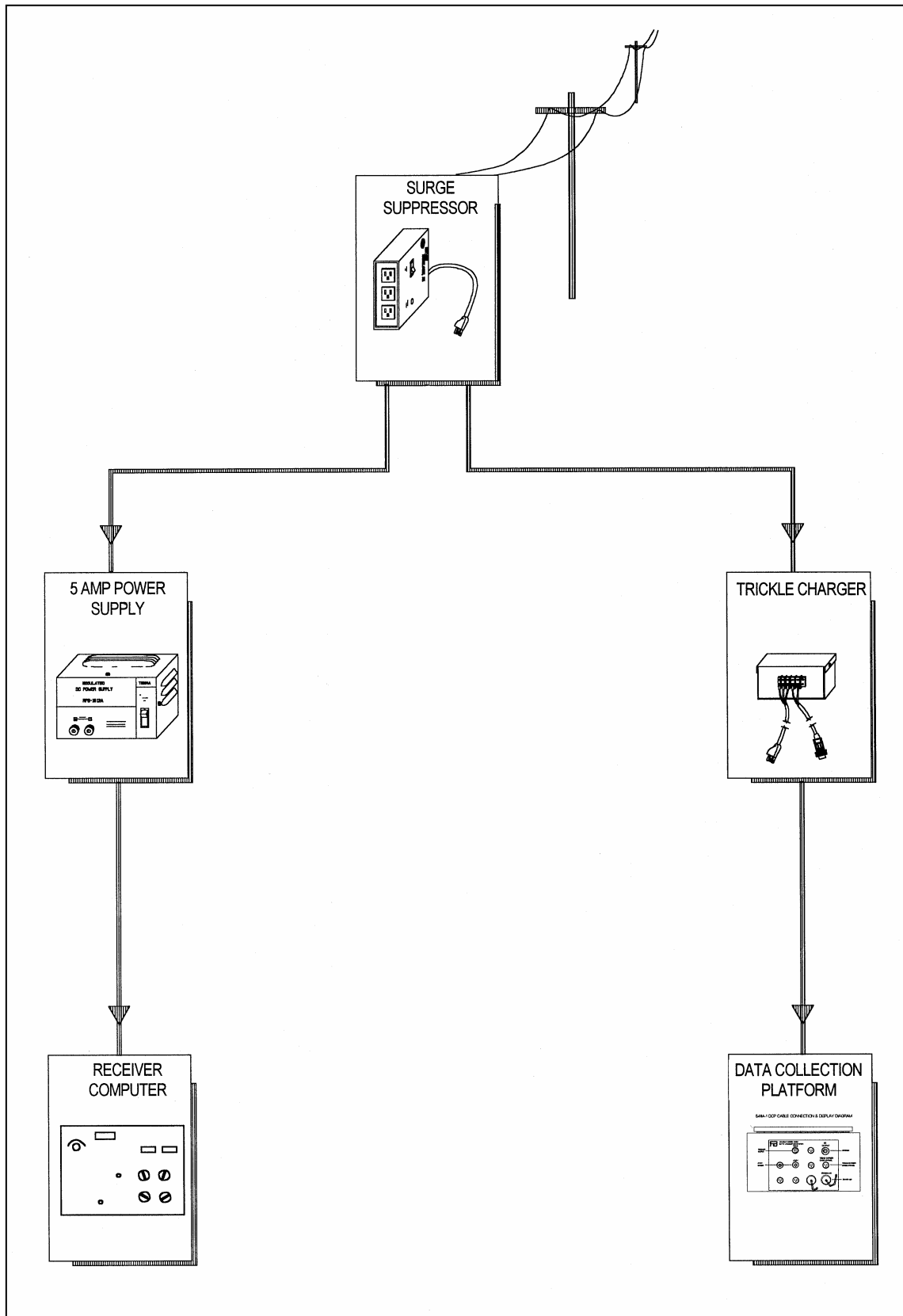

Figure 4-26. Receiver Station Line Power (AC) Configuration Diagram.

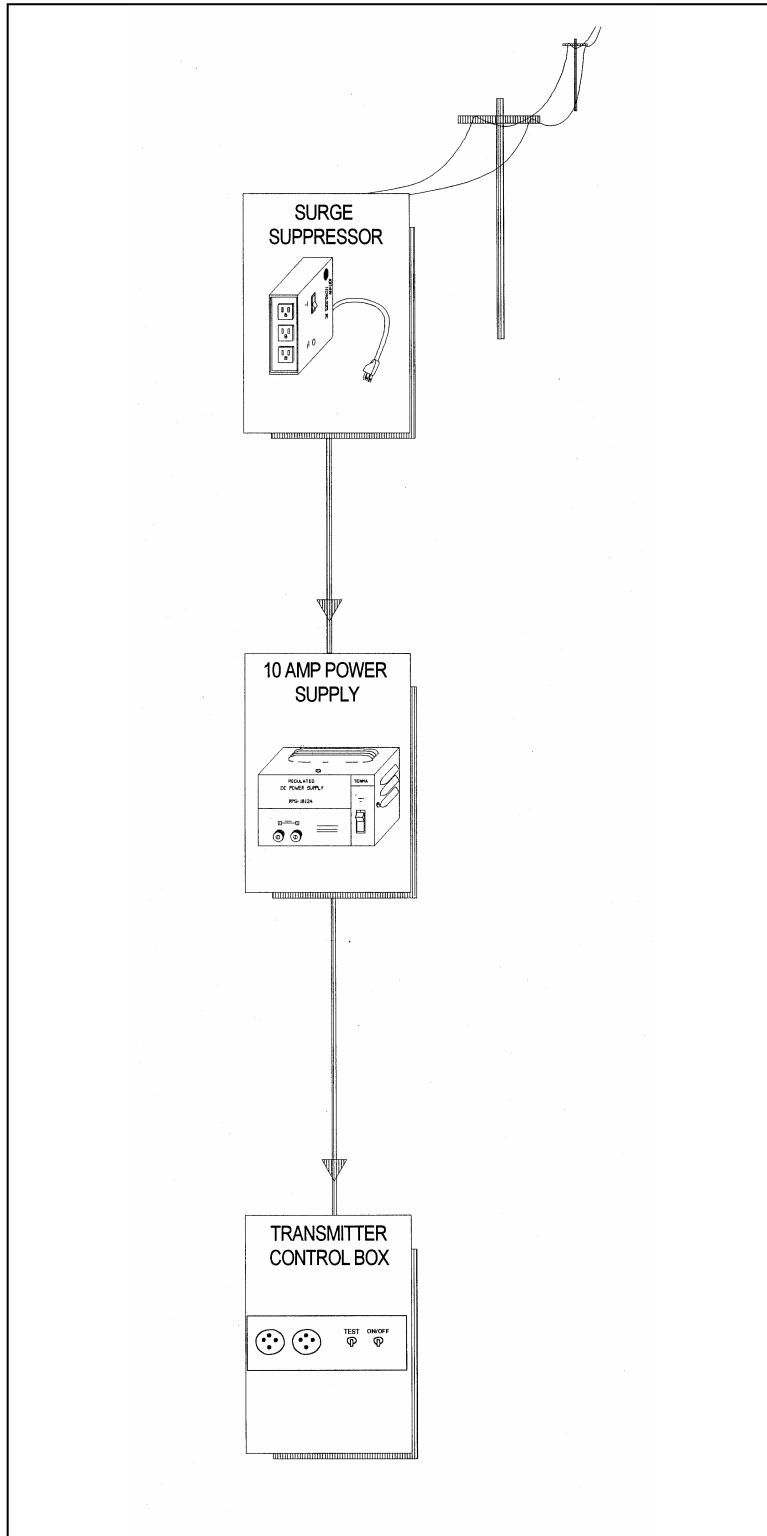

Figure 4-27. Transmitter Station Line Power (AC) Configuration Diagram.



Receiver Shelter

Instrument Solar Power Arrays

DCP Solar Panel

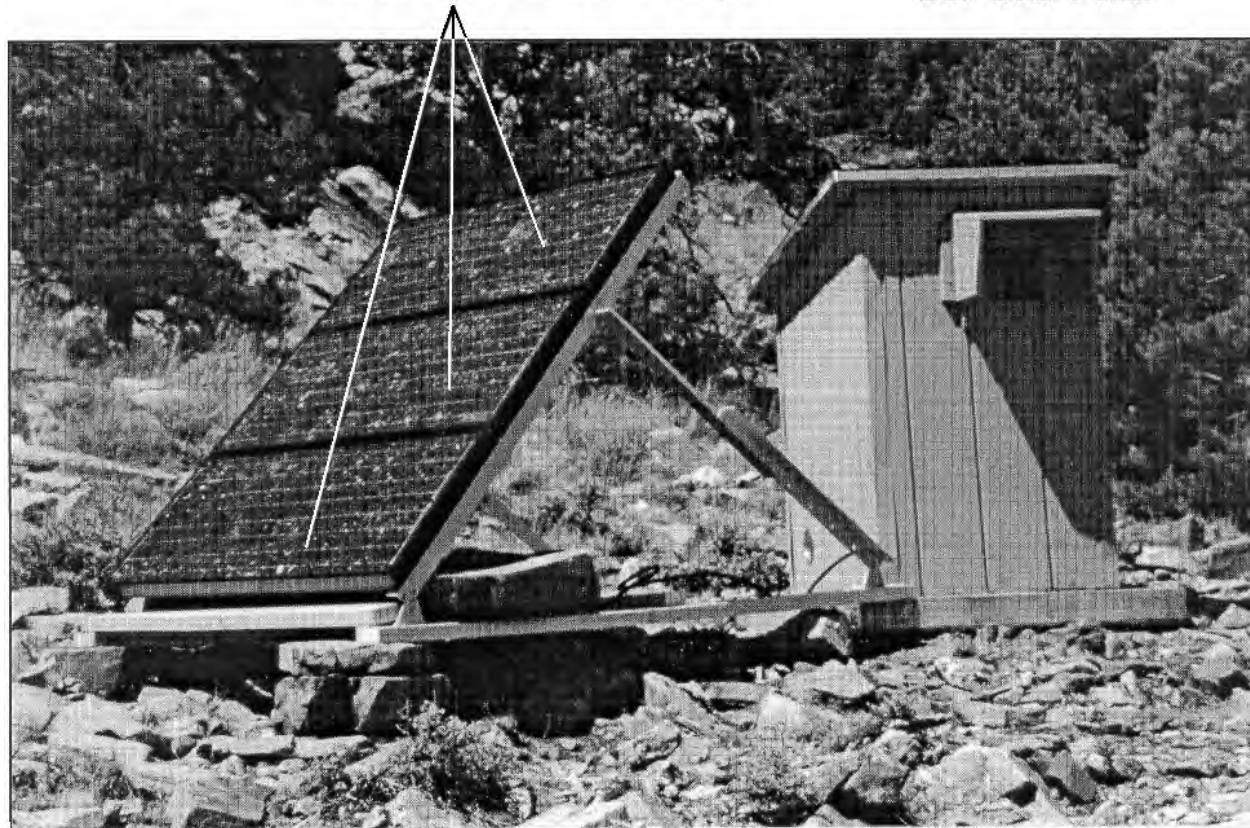

Transmitter Shelter

Figure 4-28. Solar Power Array Components (Receiver and Transmitter).

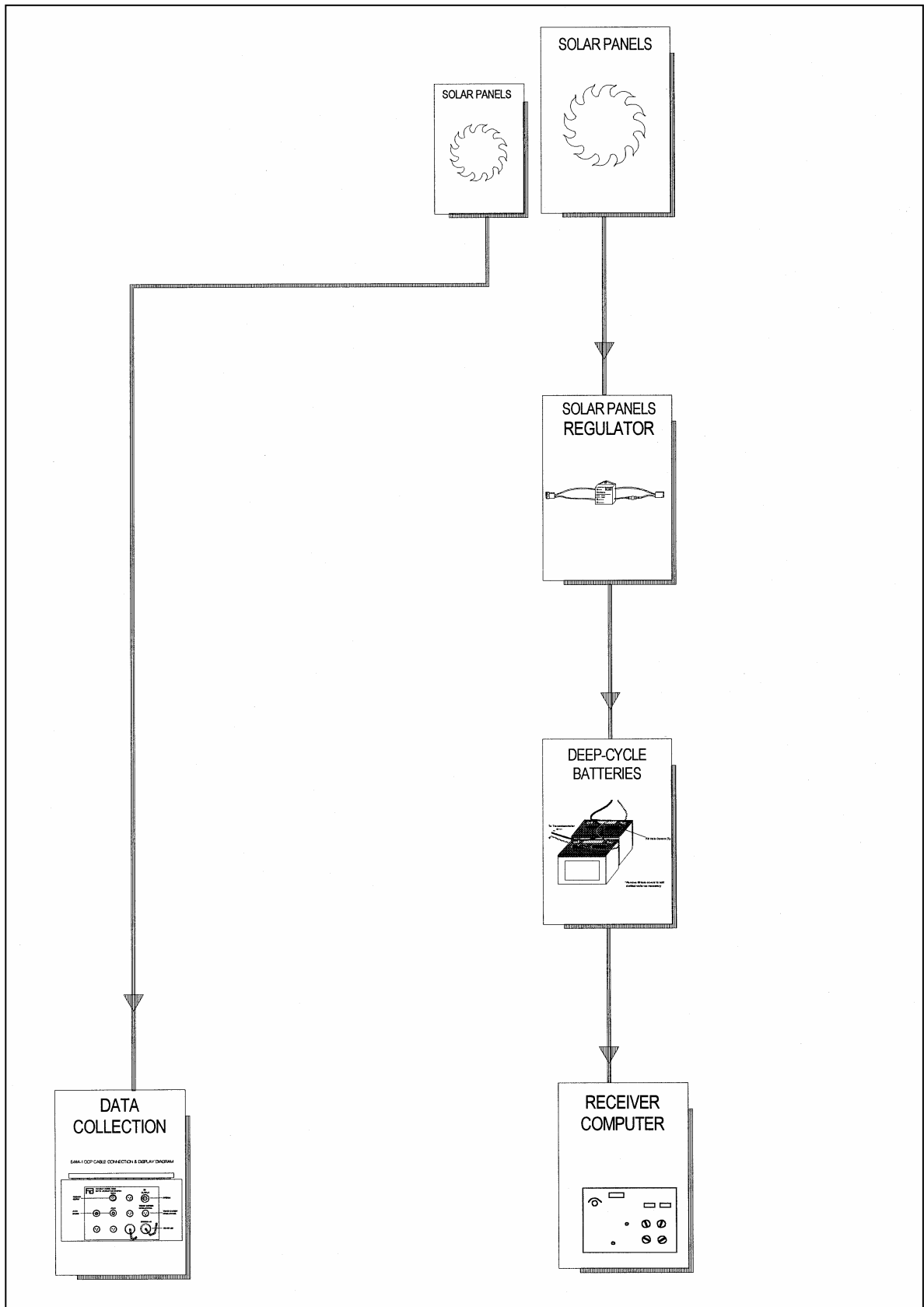

Figure 4-29. Receiver Station Solar Power (DC) Configuration Diagram.

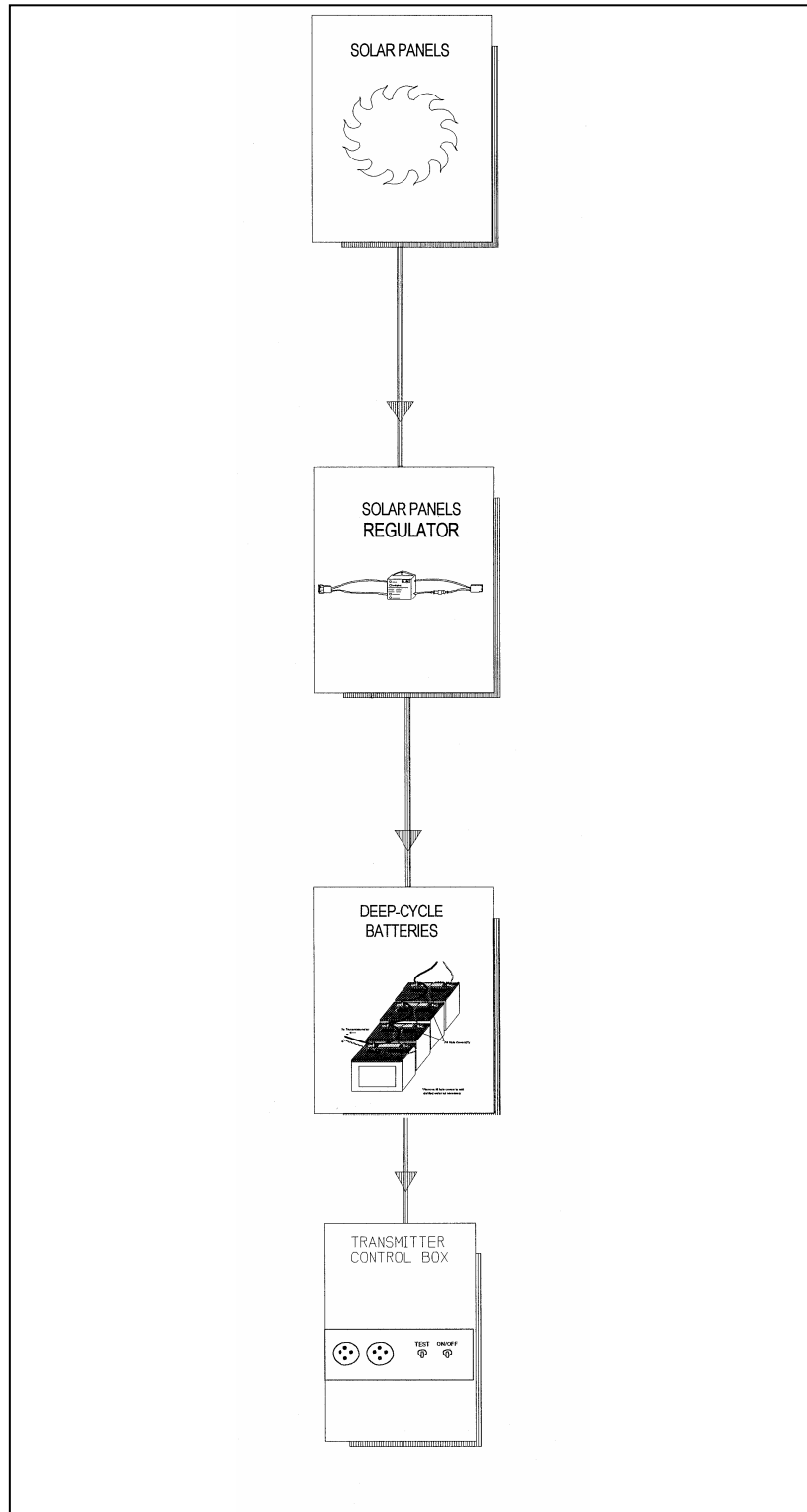

Figure 4-30. Transmitter Station Solar Power (DC) Configuration Diagram.

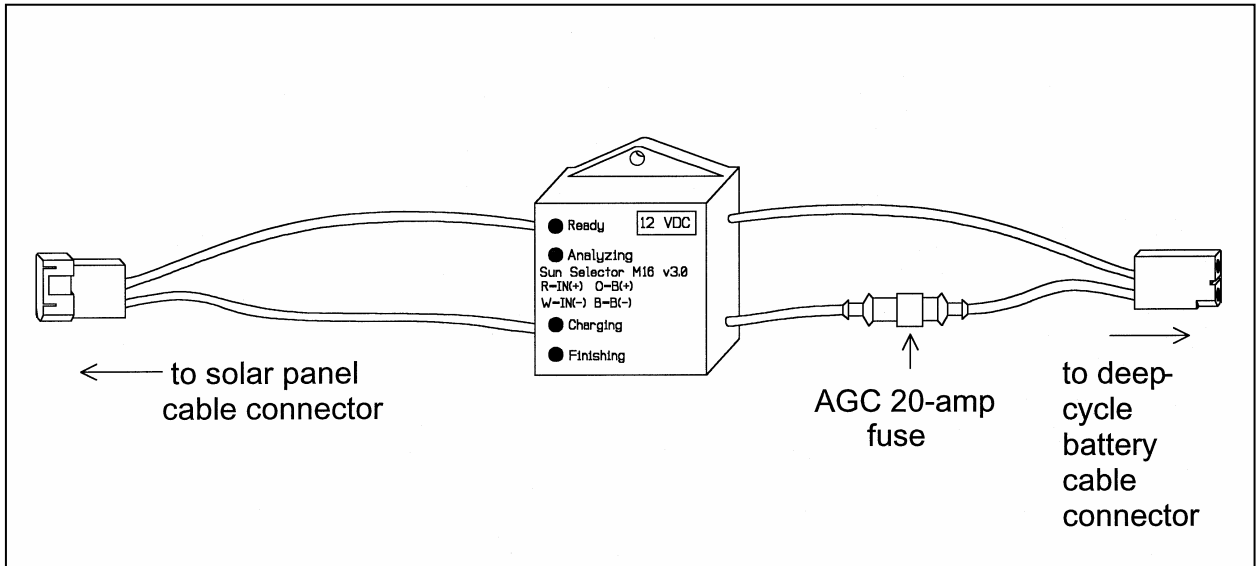

Figure 4-31. M-16 Solar Panel Regulator Diagram.

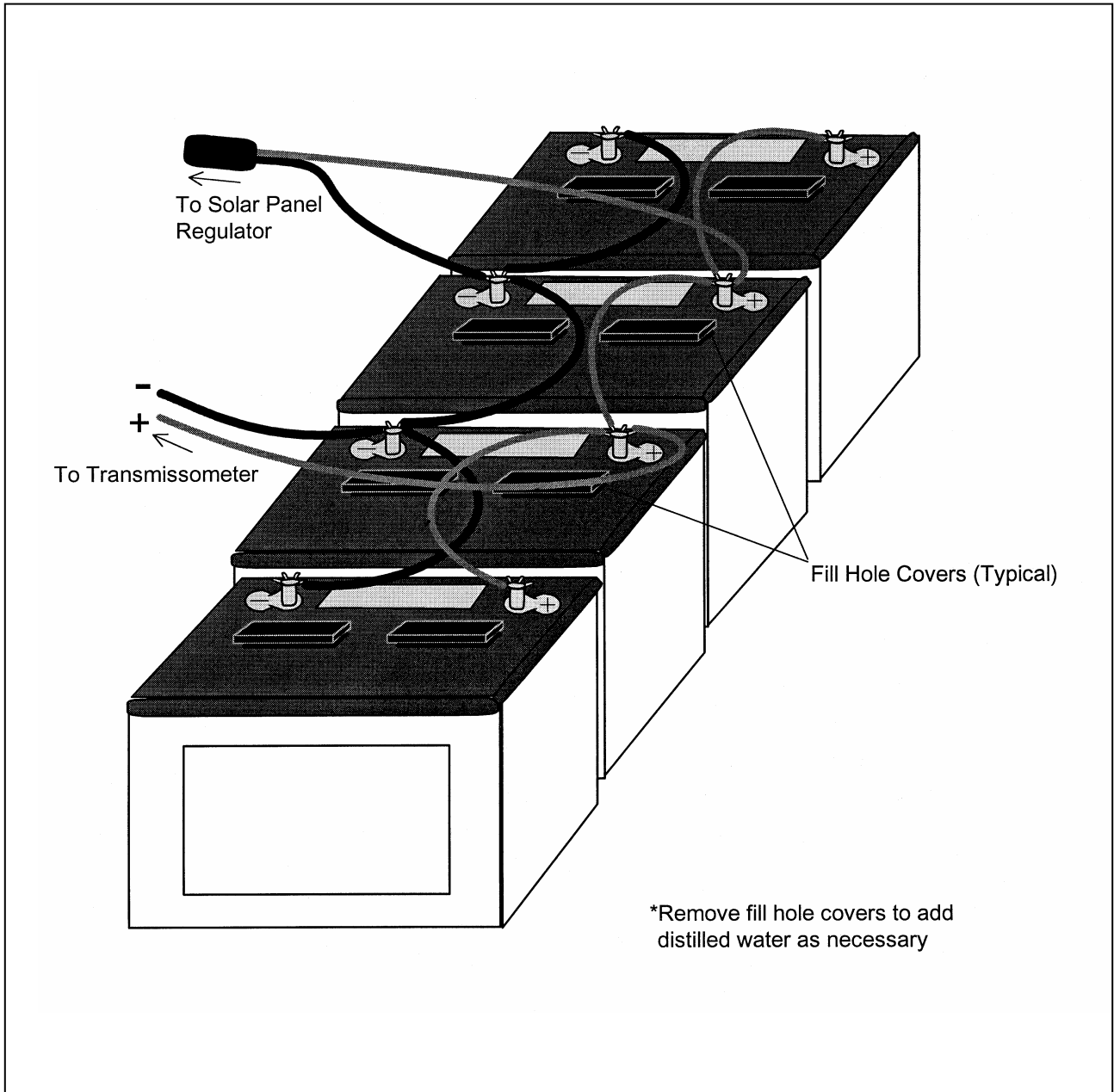

Figure 4-32. Deep-Cycle Battery and Interconnect Diagram.

QUALITY ASSURANCE/QUALITY CONTROL DOCUMENTATION SERIES	
TITLE	REPLACING AND SHIPPING TRANSMISSOMETER COMPONENTS
TYPE	TECHNICAL INSTRUCTION
NUMBER	4110-3375
DATE	JANUARY 1994

AUTHORIZATIONS		
TITLE	NAME	SIGNATURE
ORIGINATOR	J. Carter Blandford	
PROJECT MANAGER	Mark Tigges	
PROGRAM MANAGER	David L. Dietrich	
QA MANAGER	Gloria S. Mercer	
OTHER		

REVISION HISTORY			
REVISION NO.	CHANGE DESCRIPTION	DATE	AUTHORIZATIONS
1.0	Modify/add component figures.	March 1995	
1.1	Minor text and formatting changes.	August 1996	
	Reviewed; no changes necessary.	August 1997	
	Reviewed; no changes necessary.	August 1999	
	Reviewed; no changes necessary.	August 2000	
2.0	Change diagrams / delete strip charts.	August 2001	
	Reviewed; no changes necessary.	August 2002	
	-- continued --		

QUALITY ASSURANCE/QUALITY CONTROL DOCUMENTATION SERIES	
TITLE	REPLACING AND SHIPPING TRANSMISSOMETER COMPONENTS
TYPE	TECHNICAL INSTRUCTION
NUMBER	4110-3375
DATE	JANUARY 1994

AUTHORIZATIONS		
TITLE	NAME	SIGNATURE
ORIGINATOR	J. Carter Blandford	
PROJECT MANAGER	Mark Tigges	
PROGRAM MANAGER	David L. Dietrich	
QA MANAGER	Gloria S. Mercer	
OTHER		

REVISION HISTORY			
REVISION NO.	CHANGE DESCRIPTION	DATE	AUTHORIZATIONS
	Reviewed; no changes necessary.	October 2003	
3.0	Added LPV-3 systems.	December 2004	

TABLE OF CONTENTS

<u>Section</u>		<u>Page</u>
1.0	PURPOSE AND APPLICABILITY	1
2.0	RESPONSIBILITIES	1
2.1	Project Manager	1
2.2	Field Specialist	2
2.3	Data Analyst	2
2.4	Site Operator	3
3.0	REQUIRED EQUIPMENT AND MATERIALS	3
4.0	METHODS	4
4.1	Transmissometer and Support Equipment Removal	4
4.1.1	Removing the Transmitter	4
4.1.2	Removing the Receiver	5
4.1.3	Removing the DCP	9
4.1.4	Removing the 23X Datalogging System	12
4.1.5	Removing the Air Temperature/Relative Humidity Sensor	14
4.2	Transmissometer and Support Equipment Installation	14
4.2.1	Installing the Transmitter	14
4.2.2	Installing the Receiver	18
4.2.3	Installing the DCP	19
4.2.4	Installing the 23X Datalogger and Subsystem	20
4.2.5	Installing the Air Temperature/Relative Humidity Sensor	22
4.3	Packing and Shipping	23

LIST OF FIGURES

<u>Figure</u>		<u>Page</u>
4-1	LPV-2 Transmissometer Operator Log Sheet – Transmitter Station	6
4-2	Removal of Receiver Detector Head	7
4-3	LPV-2 Transmissometer Operator Log Sheet – Receiver Station	8
4-4	DCP Datalogger Component Diagram	10
4-5	DCP Cable Connection and Display Diagram	11

LIST OF FIGURES (CONTINUED)

<u>Figure</u>		<u>Page</u>
4-6	23X Datalogging System	13
4-7	Air Temperature/Relative Humidity Sensor Component Diagram	15
4-8	Transmitter Components Connection Diagram	17
4-9	Datalogging and Control Subsystem Connector Panel	22

LIST OF TABLES

<u>Table</u>		<u>Page</u>
4-1	Datalogging and Control Subsystem Connector Panel Description	6

1.0 PURPOSE AND APPLICABILITY

This technical instruction (TI) describes procedures for removing, installing, and proper packing and shipping of transmissometer monitoring system components and support equipment at a field monitoring site.

This TI, as referenced in Standard Operating Procedure (SOP) 4110, *Transmissometer Maintenance (IMPROVE Protocol)*, specifically describes:

- Disconnecting power from instruments and support equipment.
- Removing instruments and support equipment from mounting hardware.
- Removing internal batteries (if necessary).
- Packing and shipping cables and other accessories with instruments and support equipment.
- Completing removal documentation requirements for instruments and support equipment.
- Installing replacement instruments and support equipment.
- Connecting power to instruments and support equipment.
- Identifying switch settings for instruments and support equipment.
- Verifying and documenting proper operation of replacement instruments and support equipment.
- Packing instruments and support equipment for shipment.
- Shipping methods and amount of insurance required for each item.

2.0 RESPONSIBILITIES

2.1 PROJECT MANAGER

The project manager shall:

- Coordinate with the site operator, his/her supervisor, field specialist, and data analyst concerning the schedule and requirements for specific transmissometer component replacement and shipment procedures.
- Oversee and review specific transmissometer component replacement and shipment procedure documentation completed by the site operator, for completeness and accuracy.

2.2 FIELD SPECIALIST

The field specialist shall:

- Coordinate with the site operator, his/her supervisor, data analyst, and project manager concerning the schedule and requirements for specific transmissometer component replacement and shipment procedures.
- Train the site operator in all phases of specific transmissometer component replacement and shipment procedures necessary for on-site resolution of instrument problems.
- Provide technical support to the site operator via telephone to assure proper transmissometer component replacement and shipment procedures.
- Document all technical support provided to the site operator.
- Resolve problems reported by the site operator.

2.3 DATA ANALYST

The data analyst shall:

- Coordinate with the site operator, his/her supervisor, field specialist, and project manager concerning the schedule and requirements for specific transmissometer component replacement and shipment procedures.
- Identify possible instrument malfunction then contact the site operator to schedule a visit for transmissometer component replacement and shipment procedure implementation.
- Review documentation completed by the site operator for completeness and accuracy.
- Verify that scheduled visits are performed and notify the site operator if he/she fails to make a scheduled visit.
- Provide technical support to the site operator via telephone to assure proper transmissometer component replacement and shipment procedures.
- Document all technical support provided to the site operator.
- Review and file all site documentation.
- Resolve problems reported by the site operator.
- Send supplies, tools, and replacement instrumentation necessary for instrument problem resolution to the site operator.

- Make the necessary arrangements for pick-up and return shipment of malfunctioning transmissometer components.
- Enter all correspondence with site operators and the results of all performed procedures into site-specific timelines.

2.4 SITE OPERATOR

The site operator shall:

- Coordinate with his/her supervisor, field specialist, data analyst, and project manager concerning the schedule and requirements for specific transmissometer component replacement and shipment procedures.
- Perform all procedures described in this TI.
- Thoroughly document all performed transmissometer component replacement and shipment procedures on the LPV-2 Transmissometer Operator Log Sheet, and mail the log sheet to the data analyst.
- Report any noted inconsistencies immediately to the data analyst or field specialist.

3.0 REQUIRED EQUIPMENT AND MATERIALS

The following equipment is generally required for transmissometer component replacement and shipment:

- Transmissometer component shipping cases, and cloth and plastic bags
- Large, medium, and small flat-blade screwdrivers
- Keys for shelters and padlocks
- Site Operator's Manual for Transmissometer Monitoring Systems
- Transmissometer Operator Log Sheet (transmitter and receiver stations)
- Pen or pencil
- Electrical tape
- Utility knife
- Allen wrench set
- Rubber bands
- Blower brush
- Cleaning cloth
- ARS shipping labels
- Packing tape

4.0 METHODS

This section includes three (3) major subsections:

- 4.1 Transmissometer and Support Equipment Removal
- 4.2 Transmissometer and Support Equipment Installation
- 4.3 Packing and Shipping

4.1 TRANSMISSOMETER AND SUPPORT EQUIPMENT REMOVAL

Follow the procedures described in this section for disabling and removing instrumentation and support equipment. Damage to instruments can occur upon installation or removal. When removing instruments, consider the following:

- Always leave the power switch in the OFF position when removing or installing instruments.
- Avoid touching connector pins or circuit boards; static electricity may damage sensitive components.
- Double-check connectors, power polarity, and instrument settings before applying power.
- Follow procedures in the order they are given.
- If you have questions, call the data analyst before proceeding.

4.1.1 Removing the Transmitter

Take the gray, suitcase-style transmitter shipping case with you to the site, so that the instrument will be protected during transit. See Section 4.3 for packing and shipping instructions.

Follow the procedures below when removing the transmitter:

DISCONNECT

On LPV-2 systems:

- Turn the control box power switch **OFF**.
- Disconnect the power cable (black) from the control box only. Coil the cable and set it next to the battery or the power supply.
- Disconnect the control cable (gray) from both the control box and the transmitter telescope. Coil and rubber band the cable and place it in the shipping case.

DISCONNECT (continued) On LPV-3 systems:

- Turn the power off at the power supply.
- Disconnect the power cable from the transmitter. Coil the cable and set it next to the battery or the power supply.

REMOVE

On LPV-2 systems:

- Place the control box in the shipping case after first enclosing in a plastic (or white cloth) bag.
- Remove the lamp from the transmitter. Document the lamp “off” date on the log sheet and store the lamp in the black lamp case (the lamp case remains on-site).

On LPV-3 systems:

- Remove the lamp from the transmitter. Document the lamp “off” date on the log sheet and store the lamp in the black lamp case (the lamp case remains on-site).

Put the black lens cap on the telescope and insert the “filler” lamp into the lamp chamber (has electrical tape covering the back and no number) before placing the transmitter telescope in the gray, suitcase-style shipping case.

DOCUMENT

Document removal of the instrument in the “General Comments” section of the Transmissometer Operator Log Sheet – Transmitter Station (see Figure 4-1).

4.1.2 Removing the Receiver

Take the appropriate shipping cases with you to the site, so that the instrument will be protected during transit. See Section 4.3 for packing and shipping instructions. Follow the procedures below when removing the receiver:

DISCONNECT

Turn the receiver computer power switch **OFF**.

Disconnect the receiver power, output, and photometer head cables from the computer and place them aside. Coil and band the photometer head cable.



**LPV-2 TRANSMISSOMETER OPERATOR LOG SHEET
TRANSMITTER STATION**

Date _____ Local Time _____ Operator(s) _____ Location _____
Weather Conditions _____
Visibility Conditions: Excellent Good Fair Poor Estimated visual range _____ miles
Details _____

INITIAL CONDITION

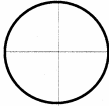
- Instrument Number LPV- _____
- Mark the initial location of receiver shelter window with a "+" in the circle below.
Comments _____

IMPORTANT: Return flip mirror to proper (ON) position.
- Was the alignment corrected? Yes No If Yes, time aligned _____
- Does the instrument appear to be working properly? Yes No
If No, provide details _____

SERVICING

- Initial Window Cleanliness: Good Moderate Poor
Comment _____
- Window Cleaned? Yes No If Yes, time cleaned _____
If No, why not? _____
- Lens Inspected? Yes No If Yes, lens cleaned? Yes No
IMPORTANT: Use only the blower brush to clean the telescope lens.
- Solar Panels Cleaned? Yes No Comment _____
- Battery Voltage (charging) _____ Battery Voltage (analyzing) _____
- Lamp Check **IMPORTANT: Must be done when lamp is ON under automatic control.**
a) LED (indicator light on side of control box) On Off (If On, telephone ARS)
b) Lamp Voltage Reading (switch voltmeter to 20 VDC range) _____ volts, for lamp number _____
IMPORTANT: Switch voltmeter to "OFF" after taking voltage reading.

TIMING

- Is your watch synchronized with NIST time? (telephone 303-499-7111 or <http://www.time.gov>) Yes No
- Transmitter Light ON, Exact Time, (HR:MIN:SEC) _____ : _____ : _____
- Transmitter Light OFF, Exact Time, (HR:MIN:SEC) _____ : _____ : _____
- Timing Reset? Yes No If Yes, time transmitter was reset _____
IMPORTANT: THE TRANSMITTER TIMING MUST ONLY BE RESET AT EXACTLY THE TOP OF THE HOUR!

SPECIAL SERVICING (upon ARS instruction)

- Lamp Changed? Yes No If Yes, old lamp number _____ Old lamp voltage _____
Time lamp changed _____ New lamp number _____ New lamp voltage _____
IMPORTANT: If lamp is changed, receiver computer calibration (CAL) number must also be changed.
- Alignment corrected after lamp change? Yes No

GENERAL COMMENTS/SUPPLIES NEEDED

Send the white copy of this form to:
(keep the yellow copy on site)

Air Resource Specialists, Inc.
1901 Sharp Point Drive, Suite E
Fort Collins, CO 80525

Telephone: 1-800-344-5423
Fax: 1-970-484-3423

Transmitter log.doc (08/01)

Figure 4-1. LPV-2 Transmissometer Operator Log Sheet - Transmitter Station.

REMOVE

Place the receiver computer in the white cloth bag provided and then in its shipping case.

Remove the detector-head from the telescope with an Allen wrench included in the tool kit (refer to Figure 4-2). Place the soft, black plastic cap on the detector-head opening. Put the detector-head first in a plastic bag and then in the white cloth bag; then place the unit in the gray, suitcase-style shipping case.

Cover both ends of the receiver telescope with the black plug and large, black cap (tighten the Allen screws to secure). Place the telescope in its shipping case.

DOCUMENT

Document removal of the instrument in the “General Comments” section of the Transmissometer Operator Log Sheet – Receiver Station (see Figure 4-3).

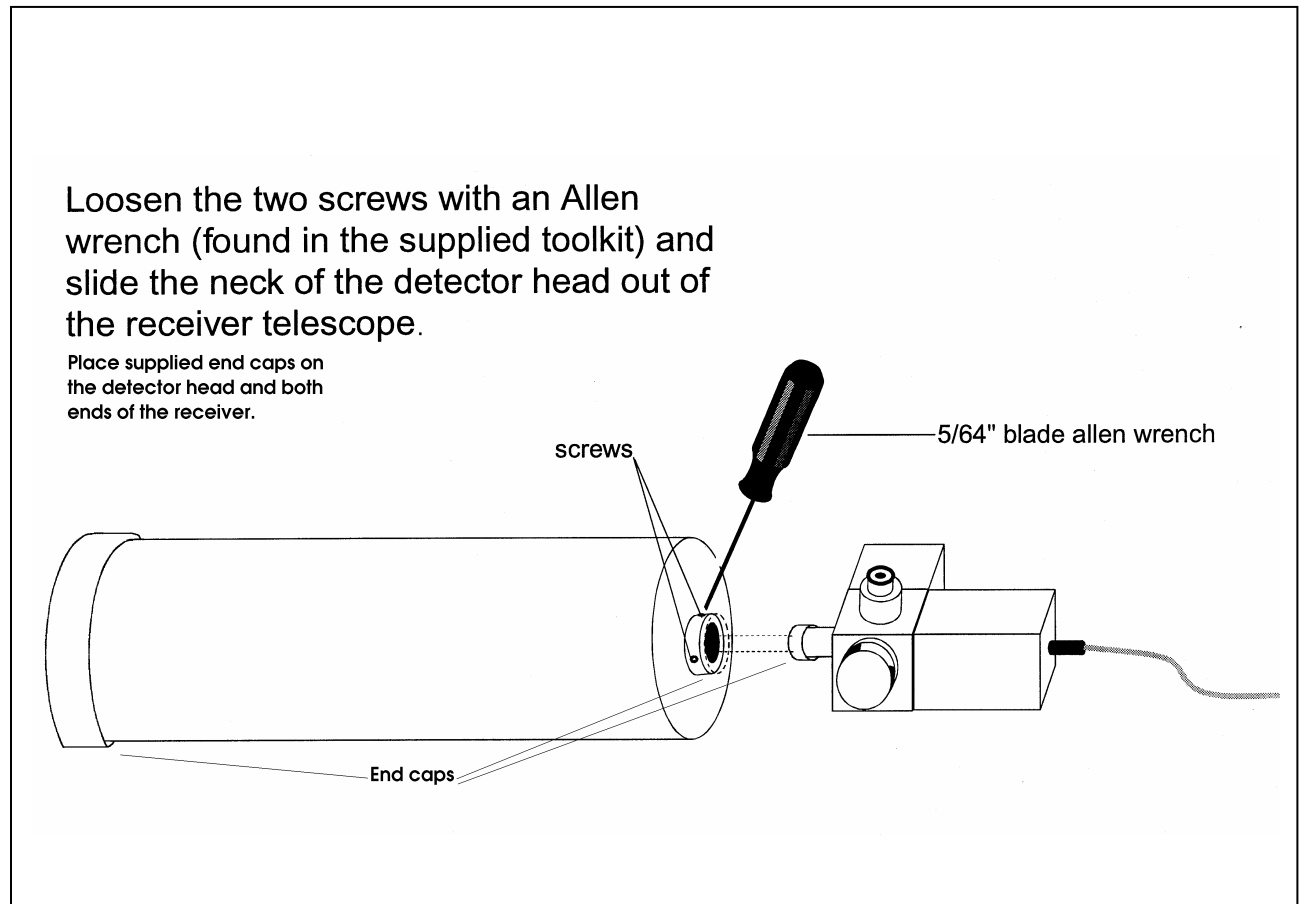

Figure 4-2. Removal of Receiver Detector Head.



**LPV-2 TRANSMISSOMETER OPERATOR LOG SHEET
RECEIVER STATION**

Date _____ Local Time _____ Operator(s) _____ Location _____
Weather Conditions _____
Visibility Conditions: Excellent Good Fair Poor Estimated visual range _____ miles
Details _____

INITIAL CONDITION

- Instrument Number LPV- _____
- Receiver Display Reading _____ Local Time _____ Toggle: On Off
- Display readings: A1 switch set to: C (raw reading) _____ B(b_{ext} reading) _____
- Does the b_{ext} reading represent actual conditions? Yes No Comment _____
- Mark the initial location of transmitter light source with a "+" in the circle below.

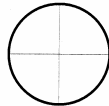

Comments _____

IMPORTANT: Return flip mirror to proper (ON) position.

- Was the alignment corrected? Yes No If Yes, time aligned _____
- Does the instrument appear to be working properly? Yes No
If No, provide details _____

SERVICING

- Initial Window Cleanliness: Good Moderate Poor Comment _____
- Window Cleaned? Yes No If Yes, time cleaned _____ If No, why not? _____
- Lens Inspected? Yes No If Yes, lens cleaned? Yes No
IMPORTANT: Use only the blower brush to clean the telescope lens.
- Solar Panels Cleaned? Yes No Comment _____
- Battery Voltage (charging) _____ Battery Voltage (analyzing) _____

TIMING

- Is your watch synchronized with NIST time? (telephone 303-499-7111 or <http://www.time.gov>) Yes No
- Transmitter Light ON, Exact Time, (HR:MIN:SEC) _____:_____:_____
- Receiver Toggle Update, Exact Time, (HR:MIN:SEC) _____:_____:_____
- Updated Receiver Reading: C(raw reading) _____ B(b_{ext} reading) _____ Toggle: On Off

IMPORTANT: Return A1 switch to "C" position after check.

Does the updated b_{ext} reading represent your estimate of visual range? Yes No
Comment _____

- Transmitter Light OFF, Exact Time, (HR:MIN:SEC) _____:_____:_____
- Computer Reset? Yes No If Yes, time reset _____

IMPORTANT: THE RECEIVER COMPUTER TIMING MUST ONLY BE RESET AT EXACTLY 3 MINUTES AFTER THE HOUR!

SPECIAL SERVICING (upon ARS instruction)

- Lamp Changed at Transmitter Station? Yes No
IMPORTANT: If lamp is changed, receiver computer calibration (CAL) number must also be changed.
- Receiver computer CAL number changed? Yes No If Yes, new CAL number entered: _____

GENERAL COMMENTS/SUPPLIES NEEDED

Send the white copy of this form to:
(keep the yellow copy on site)

Air Resource Specialists, Inc.
1901 Sharp Point Drive, Suite E
Fort Collins, CO 80525

Telephone: 1-800-344-5423
Fax: 1-970-484-3423

Figure 4-3. LPV-2 Transmissometer Operator Log Sheet - Receiver Station.

4.1.3 Removing the DCP

Refer to Figure 4-4, DCP Datalogger Component Diagram, for the location of the switches and connectors discussed. Figure 4-4 depicts the dial switches in detail.

IMPORTANT: Before disconnecting the DCP antenna cable, some internal switch settings must be changed to inhibit transmissions. Failure to do so will damage the DCP.

Follow the procedures below when removing the DCP:

RESET

Loosen the clasps and open the hinged door of the DCP. Locate the six square, red dial switches located on the circuit board on the inside of the door. Refer to close-up of dial switches in Figure 4-4.

Using a small, flat-blade screwdriver, reset the switches under “CHAN 1” to **9, 0, 0**. The switch immediately below the “100” on the circuit board should be set to **9**. The switches immediately below the “10” and the “1” on the circuit board should be set to **0**.

Close the DCP door and tighten the clasps.

DISCONNECT

Before disconnecting the connectors on the side of the DCP, note their locations and mark if necessary. Draw a wiring diagram if you think it will be helpful. Refer to Figure 4-5, DCP Cable Connection and Display Diagram.

Disconnect all cables from the DCP input panel and remove the DCP. Pack the unit for shipping in the supplied box.

DOCUMENT

Document the removal of the DCP in the “General Comments” section of the Transmissometer Operator Log Sheet – Receiver Station (see Figure 4-3).

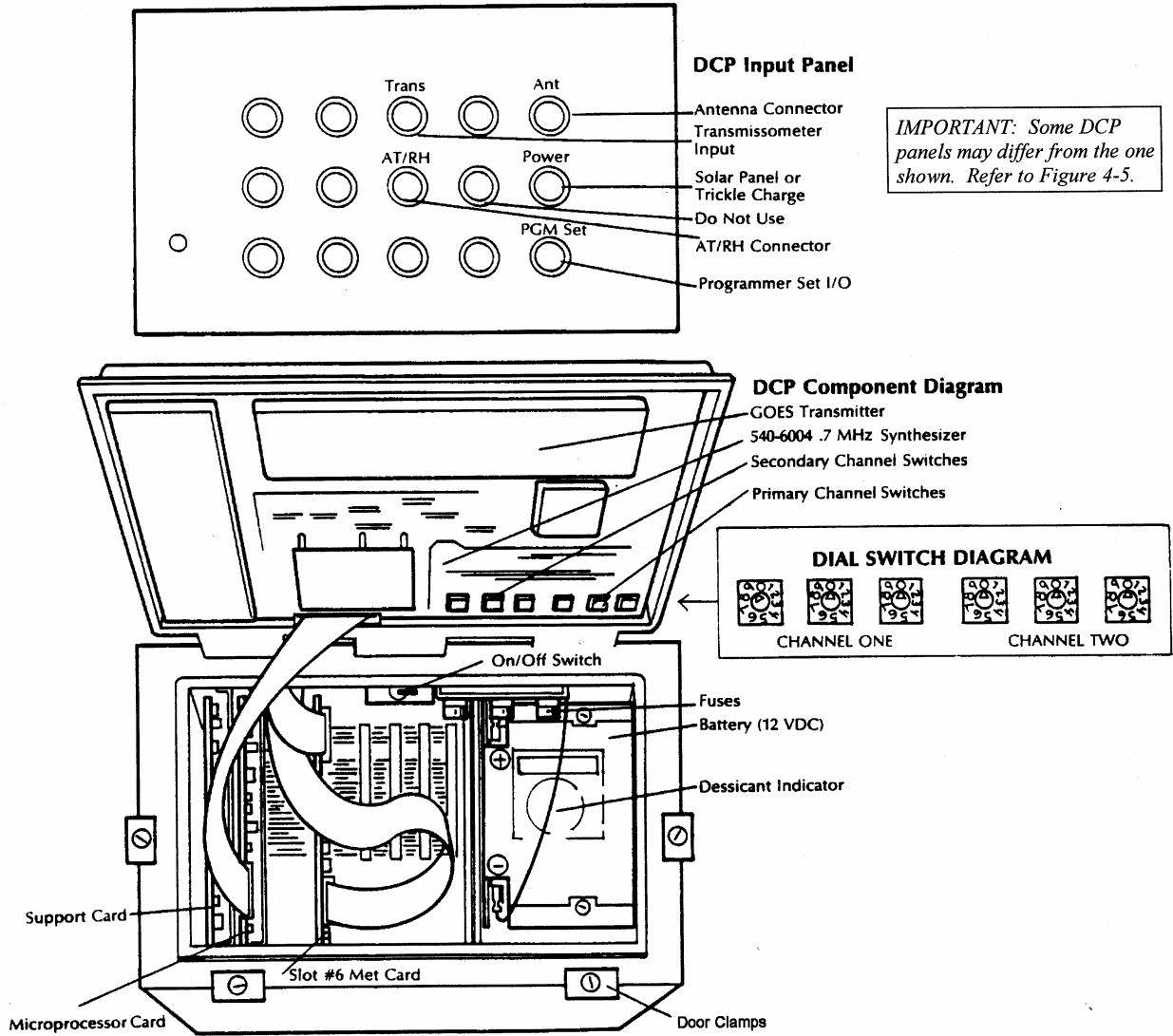

Side View DCP Input Panel

IMPORTANT--DCP panels may differ from the above unit.

Figure 4-4. DCP Datalogger Component Diagram.

540A-1 DCP CABLE CONNECTION & DISPLAY DIAGRAM

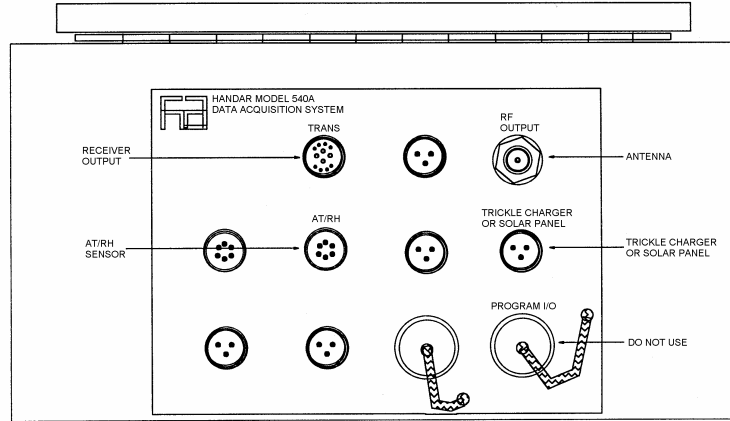

540A-2 DCP CABLE CONNECTION & DISPLAY DIAGRAM

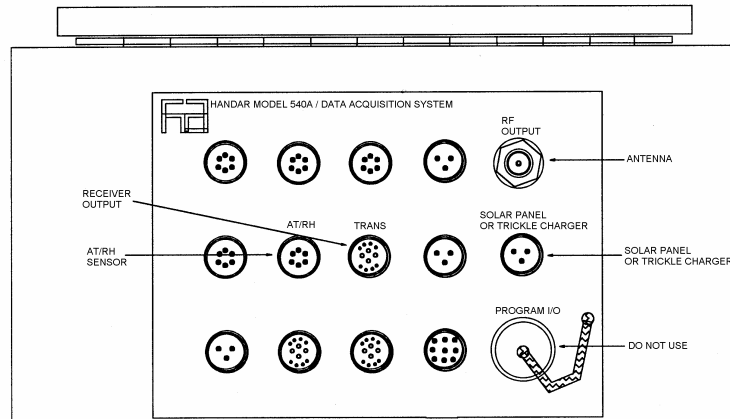

570 DCP CABLE CONNECTION & DISPLAY DIAGRAM

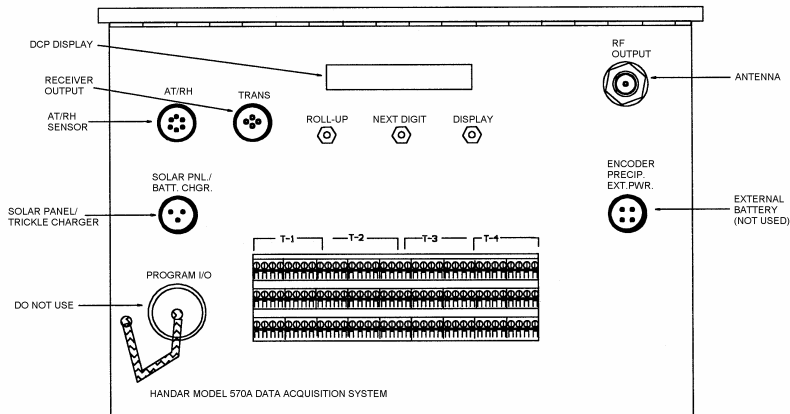

Figure 4-5. DCP Cable Connection and Display Diagram.

4.1.4 Removing the 23X Datalogging System

Take the appropriate case or box to the site when removing the 23X datalogging system so that the instrument will be protected during transit. See Section 4.3 for packing and shipping instructions. Figure 4-6 is a diagram of the 23X datalogging system. Follow the procedures below for removal and packing of the enclosure:

DISCONNECT

Disconnect power to the enclosure at the main AC supply (e.g., breaker box or wall plug).

Disconnect all cables from the bottom outside of the enclosure.

Tape the end of each cable connector with electrical tape. Allow the connectors to hang down to prevent moisture from entering.

Open the enclosure and place packing material (bubble-wrap) around the following items to assure they will be secure during transit:

- Campbell datalogger
- Campbell storage module
- Campbell modem
- AC surge protector
- Other loose components

Verify that all components in the enclosure are secure for shipping.

REMOVE

Loosen and remove the four (4) bolts securing the enclosure to the tower, or remove any other mounting screws securing the enclosure.

Carefully pack the enclosure in the shipping case or box using packing material to protect the enclosure during transit.

DOCUMENT

Document the removal of this sensor on the log sheet.

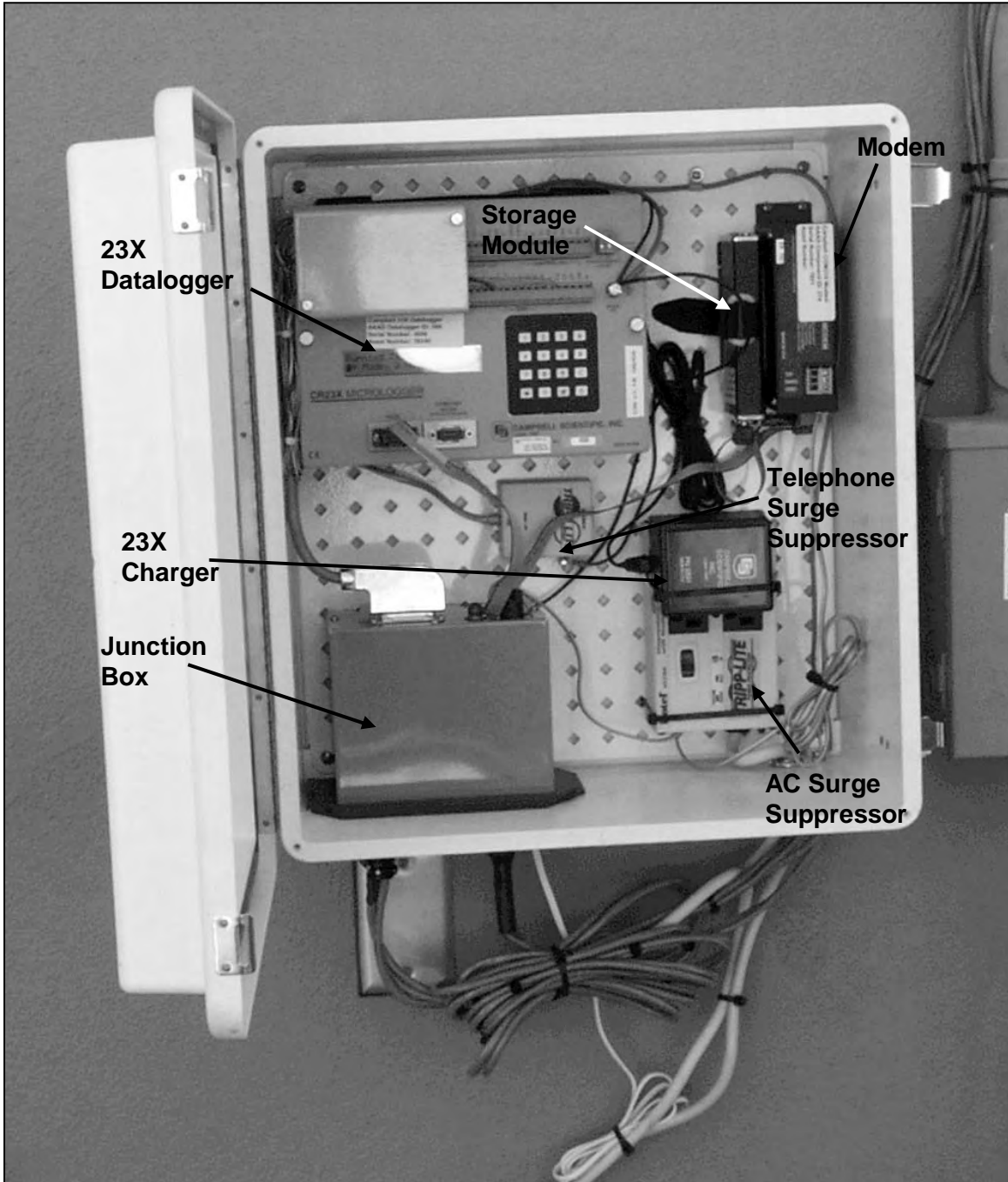

Figure 4-6. 23X Datalogging System.

4.1.5 Removing the Air Temperature/Relative Humidity Sensor

Follow the procedures below when removing the air temperature and relative humidity sensor:

DISCONNECT Disconnect the air temperature/relative humidity cable at the connection below the sensor (see Figure 4-7, Air Temperature/Relative Humidity Sensor Component Diagram). In most cases, a replacement AT/RH sensor will need to be installed when removing a suspect or malfunctioning AT/RH sensor. (Refer to Section 4.2.5 for AT/RH sensor installation instructions).

Cover the end of the cable connector with electrical tape if no replacement AT/RH sensor is to be installed. Allow the connector to hang down to prevent moisture from entering the connector.

REMOVE Loosen the two clamps that hold the sensor in place and slide the sensor out.

Pack the sensor in the shipping case that the replacement sensor was shipped in (or in an appropriate shipping box).

DOCUMENT Document the removal of this sensor on the receiver station log sheet.

4.2 TRANSMISSOMETER AND SUPPORT EQUIPMENT INSTALLATION

Replacement transmissometer components will be shipped directly to the site operator by ARS. Upon receipt of the shipment, the site operator should follow the component-specific procedures listed below.

4.2.1 Installing the Transmitter

Follow the procedures below when installing the transmitter:

INSTALL Inspect shipping case(s) for signs of damage upon receiving the instrumentation. Remove the transmitter from the shipping case, the cloth and plastic bags from the instrument, and black cap and “filler” lamp. Save all of the bags, rubber bands, etc., for return shipping.

Mount the transmitter on the alti-azimuth base and tighten the telescope hold-down screw. **DO NOT REFOCUS THE TRANSMITTER.**

Install the lamp number requested by ARS. Call ARS for additional instructions if needed.

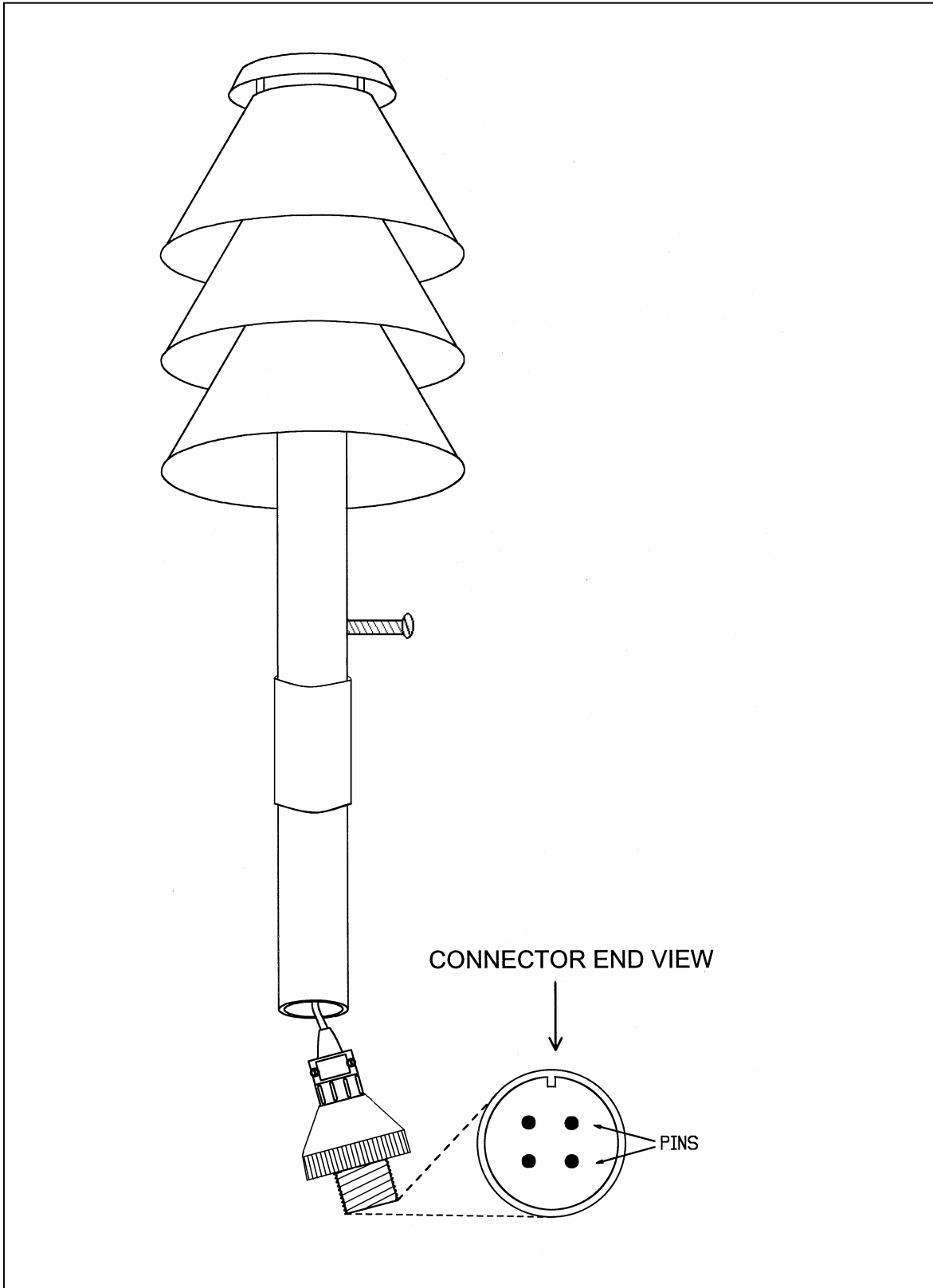

Figure 4-7. Air Temperature/Relative Humidity Sensor Component Diagram.

INSTALL (continued)

Clean the objective lens with the blower brush.

On LPV-2 systems, install the control box. Make sure the on/off and test switches are in the OFF (down) position.

CONNECT

On LPV-2 systems:

- Connect the control cable to the instrument and the control box making sure to set the connectors properly. A small detent can be felt when the connectors are fully seated. Verify that the control cable connector attached to the instrument (transmitter telescope) includes the “measurement pigtail” as shown in Figure 4-8. Connect the red and black banana jacks to the same color connectors on the side of the transmitter lamp housing.
- Connect the control box power cable. Check that the power cable is securely connected to the battery (DC power), or the power supply (AC power).
- Turn the control box on/off switch **ON** and reset the system timing (refer to TI 4110-3100, *Routine Site Operator Maintenance Procedures for LPV-2 Transmissometer Systems (IMPROVE Protocol)*).

On LPV-3 systems:

- Connect the power cable to the transmitter. Check that the power cable is securely connected to the battery (DC power), or the power supply (AC power).
- Turn the power supply **ON**. If the transmissometer system will be operating on a cycle, reset the system timing (refer to TI 4110-3105, *Routine Site Operator Maintenance Procedures for LPV-3 Transmissometer Systems (IMPROVE Protocol)*).

DOCUMENT

Upon successful installation of the transmitter, complete the tasks listed on the transmitter station log sheet. Document the installation of the system and the lamp number placed into service on the transmitter station log sheet.

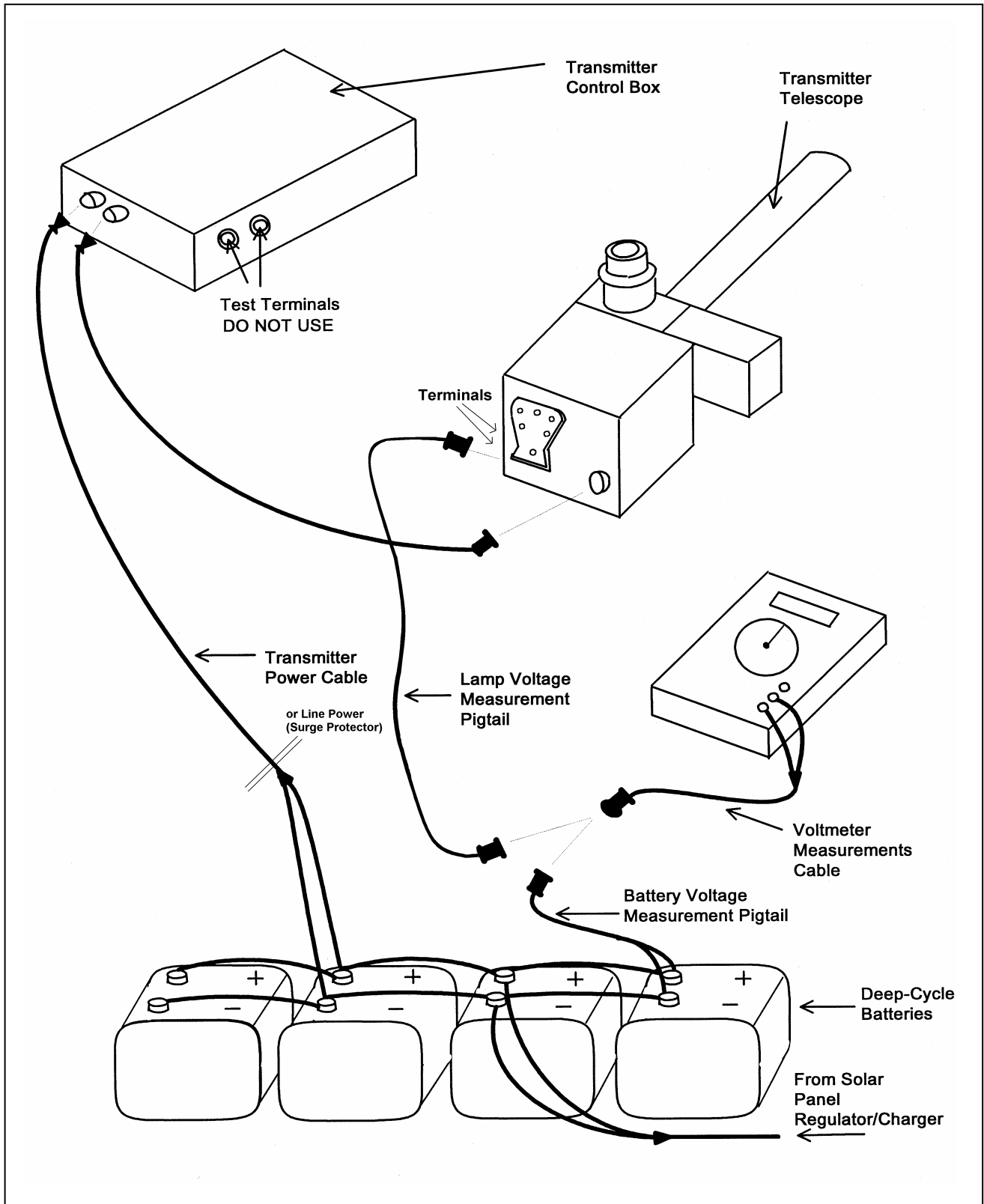

Figure 4-8. Transmitter Components Connection Diagram.

4.2.2 Installing the Receiver

Follow the procedures below when installing the receiver:

INSTALL

Remove the receiver telescope from the shipping case. Remove the cloth and plastic bags, black plug, and large, black cap from the instrument. Save all of the bags, rubber bands, etc. for return shipping.

Mount the telescope on the alti-azimuth base and tighten the telescope hold-down screw.

Clean the objective lens with the blower brush.

Mount the detector-head (photometer) to the telescope by tightening the two retaining Allen screws after fully seating the assembly. The sides of the eyepiece/detector-head assembly should be perpendicular to the ground.

Remove the receiver computer from the shipping case, remove the cloth bag, and place the computer in its correct position in the shelter. Make sure the power switch is **OFF**. Remove the four top-cover screws and take the top cover of the receiver computer off.

Touch the receiver computer case and any large, metal object (such as the unpainted portion of the monitoring post) to rid yourself of static electricity.

Push down on the computer cards carefully to make sure they are fully seated.

Push down on the ribbon connector and the small two-conductor connector located on the top cards.

Replace the computer cover and tighten the four screws. Connect the output cable from the datalogging system, and the power cable from the battery or power supply, to the back panel of the receiver computer.

CONNECT

Plug the cable from the detector-head into the photometer input on the back panel of the receiver computer.

Turn the computer power switch to the ON position. The display should go to "000" or "001" and the toggle light should be off. The OR light should come on for 2-3 seconds and then go off.

CONNECT (continued) Align the telescope and leave the flip mirror ON. To reset the computer, turn the computer **OFF** and back **ON** at the top of the hour. To reset system timing, toggle the reset switch at 3 minutes after the top of the hour (or 3 minutes after the transmitter light comes on). An updated reading and toggle change should occur at 13 minutes past the hour (or 10 minutes after the timing reset). Refer to TI 4110-3100, *Routine Site Operator Maintenance Procedures for LPV-2 Transmissometer Systems (IMPROVE Protocol)* or TI 4110-3105, *Routine Site Operator Maintenance Procedures for LPV-3 Transmissometer Systems (IMPROVE Protocol)*.

DOCUMENT Upon successful installation of the system, complete the tasks listed on the receiver station log sheet. Document the installation of the system on the log sheet.

Store the shipping cases in the receiver station if there is enough room, otherwise, store the shipping cases in an easily accessible location (e.g., at your office).

Call ARS and notify the data analyst after the transmissometer has been installed.

4.2.3 Installing the DCP

Any replacement data collection platform (DCP) sent from ARS will be preprogrammed and in its RUN mode. It will start collecting data as soon as the sensor input cables are attached. Data will be transmitted after the antenna cable is attached and internal channel selection switches are set to the proper position. Refer to Figure 4-4, DCP Datalogger Component Diagram, for the location of described parts. Follow the procedures below when installing the DCP:

INSTALL Notify the data analyst before going into the field to install the DCP. The channel must be activated with the satellite service center prior to transmitting.

Locate the new DCP in the correct position within the shelter.

CONNECT Connect the trickle charger or solar panel power cable to the correct position on the DCP panel. If a solar panel is used, the cable should be connected directly to the connector labeled "Solar Panel Trickle Charger." If AC power is used, the trickle charger should be plugged into the same connector.

Connect the antenna to the gold coaxial connector located on the upper-right of the input panel.

Connect the sensor output cable from receiver computer to the connector labeled "TRANS."

CONNECT (continued)	<p>Connect the air temperature/relative humidity sensor cable to the position labeled “air temperature/relative humidity.”</p> <p>Loosen the door clamps with a large, flat-blade screwdriver and open the DCP door.</p> <p>Change the setting of transmission channel 1 from “900” (3 switches) to the channel requested by ARS. Channels used will be “009” for eastern sites and either “014,” “038,” or “002” for western sites.</p> <p>Close the DCP door and re-tighten the clasps.</p> <p>Check the antenna alignment, elements, and cable.</p>
DOCUMENT	<p>Store the DCP shipping box, unless it is needed to return a malfunctioning DCP.</p> <p>Document the DCP installation on the receiver station log sheet.</p> <p>Notify the data analyst when the installation is complete.</p>

4.2.4 Installing the 23X Datalogger and Subsystem

Follow the procedures below when installing the datalogging and control subsystem:

INSTALL	<p>Carefully unpack the enclosure.</p> <p>Open the enclosure and remove packing material (bubble-wrap) from any components secured for shipping. The following items may require unpacking:</p> <ul style="list-style-type: none">• Campbell datalogger• Campbell storage module• Campbell modem• AC surge protector• Other loose components <p>Verify that all components in the enclosure are positioned properly (see Figure 4-6).</p> <p>Check for loose wiring in the enclosure, especially on the datalogger terminal strips and verify the DB25 connector on the top of the junction box is properly connected.</p> <p>Attach the enclosure to the tower or other mounting support using four (4) bolts or screws.</p>
---------	---

CONNECT

Connect the following cables to the AC connectors and connector panel on the bottom outside of the enclosure after inspecting for dust and debris within the connectors:

- AC power
- Transmissometer signal
- AT/RH sensor with fan power
- Telephone line

Figure 4-9 and Table 4-1 describe the connectors on the subsystem. Use a blower brush to clean the connector if needed. Wipe a cleaning cloth around the thread inside the connectors if excess dust has collected there.

Turn on or plug in the main AC power supply to the enclosure.

Program the datalogger and set the time to local standard time and Julian date. (Refer to TI 4110-3105, *Routine Site Operator Maintenance Procedures for Optec LPV-3 Transmissometer Systems (IMPROVE Protocol)*).

Verify correct operation of the datalogging system (see TI 4100-3105).

DOCUMENT

Document the 23X installation on the receiver station log sheet.

Notify the data analyst when the installation is complete.



Figure 4-9. Datalogging and Control Subsystem Connector Panel.

Table 4-1

Datalogging and Control Subsystem Connector Panel Description

Connector	Function
Male 9-pin	Transmissometer Receiver
Male 9-pin	AT/RH
Male 4-pin	Power
Serial	Laptop (if used)
Telephone	Telephone line

4.2.5 Installing the Air Temperature/Relative Humidity Sensor

Follow the procedures below when installing the air temperature and relative humidity sensor:

INSTALL Slip the sensor into the mounting clamps; do not tighten at this time.

CONNECT Attach the sensor input/output cable after inspecting for dust and debris within the connector. Use the blower brush to clean the connector, if needed. Wipe a cleaning cloth around the thread inside the connector if excess dust has collected there.

Tighten the sensor mounting clamps.

DOCUMENT Document the installation of the sensor on the receiver station log sheet.

Call ARS to advise the data analyst of the installation.

4.3 PACKING AND SHIPPING

SHIPPING CASES Shipping cases have been provided for the transmissometer receiver, transmitter, and datalogging system. Shipping containers for other equipment or instruments must be found locally (or will be provided by ARS upon request).

SHIPPING COSTS Shipping costs should be charged to the air quality project's account. Other arrangements can be made if:

- A FedEx airbill is included with shipment of replacement instrumentation; shipment will be paid through the ARS account.
- A UPS shipment is required and cannot be charged to the air quality account.
- There are problems meeting insurance requirements (government use of U.S. Mail).
- An air quality account does not exist.

Call ARS to discuss alternate plans for covering shipping costs.

SHIPPING MISCELLANEOUS Use packing tape to seal the shipping cases. When shipping items in a cardboard box, use nylon filament packing tape to help strengthen the box. If the shipped items are not expected at ARS, or if an explanation on the return of the items would be valuable, enclose it in an envelope within the shipping case or box.

SHIPPING ADDRESS Mail all items including correspondence and instruments to (or use ARS shipping labels):

Air Resource Specialists, Inc.
1901 Sharp Point Drive, Suite E
Fort Collins, CO 80525

Telephone: 970/484-7941 or 800/344-5423

Notify ARS when and with which shipper monitoring components were sent so a delivery date can be expected.

QUALITY ASSURANCE/QUALITY CONTROL DOCUMENTATION SERIES

TITLE **ANNUAL LABORATORY MAINTENANCE PROCEDURES FOR OPTEC
LPV-2 TRANSMISSOMETER SYSTEMS (IMPROVE PROTOCOL)**

TYPE **TECHNICAL INSTRUCTION**

NUMBER **4110-3400**

DATE **APRIL 1995**

AUTHORIZATIONS

TITLE	NAME	SIGNATURE
ORIGINATOR	James H. Wagner	
PROJECT MANAGER	James H. Wagner	
PROGRAM MANAGER	David L. Dietrich	
QA MANAGER	Gloria S. Mercer	
OTHER		

REVISION HISTORY

REVISION NO.	CHANGE DESCRIPTION	DATE	AUTHORIZATIONS
0.1	Add materials/references, format change.	August 1996	

TABLE OF CONTENTS

<u>Section</u>	<u>Page</u>
1.0 PURPOSE AND APPLICABILITY	1
2.0 RESPONSIBILITIES	1
2.1 Project Manager	1
2.2 Instrument Technician	2
2.3 Field Specialist	2
2.4 Data Coordinator	2
3.0 REQUIRED INSTRUMENTATION, TOOLS, EQUIPMENT, AND MATERIALS	2
3.1 Electronics Laboratory Instrumentation	2
3.2 Optical Laboratory Equipment and Instrumentation	3
3.3 Specialized Transmissometer Servicing Support Equipment	3
3.4 Cleaning and Servicing Supplies	4
3.5 Hand Tools	5
3.6 Servicing Forms and Instrument Manuals	5
4.0 METHODS	6
4.1 Post-Field Inspection, Test, and Calibration	6
4.1.1 Initial Inspection and Functional Tests	8
4.1.1.1 Initial Inspection	8
4.1.1.2 Transmitter Functional Check	11
4.1.1.3 Receiver Functional Check	11
4.1.1.4 Serial Card Tests	16
4.1.1.5 Toggle Voltage Test	19
4.1.1.6 Receiver Computer Gain Test	21
4.1.2 Detector Uniformity Check and Post-Field Calibration	21
4.1.3 Post-Field Alignment Check	21
4.1.3.1 Transmitter Alignment Check	21
4.1.3.2 Receiver Detector Saturation Check	23
4.1.3.3 Receiver Detector Alignment Check	26
4.1.3.4 Receiver Detector Output Check	27
4.2 Annual Servicing	28
4.2.1 Transmitter Servicing and Functional Tests	28
4.2.1.1 Transmitter Telescope and Lamp Housing	29
4.2.1.2 Transmitter Control Box	36
4.2.1.3 Transmitter Lamp Alignment and Voltage Setup	37
4.2.1.4 Transmitter Functional Test	41

TABLE OF CONTENTS (CONTINUED)

<u>Section</u>	<u>Page</u>
4.2.2 Receiver Servicing and Functional Tests	41
4.2.2.1 Receiver Telescope Servicing	41
4.2.2.2 Receiver Detector Head Servicing	43
4.2.2.3 Receiver Computer Servicing	44
4.2.2.4 Receiver Functional Tests	44
4.2.2.5 Serial Card Tests	46
4.2.2.6 Toggle Voltage Test	49
4.2.2.7 Receiver Computer Gain Test	50
4.2.3 Transmitter/Receiver Optical Alignment	50
4.2.3.1 Transmitter Alignment Check	52
4.2.3.2 Receiver Detector Alignment	53
4.2.3.3 Receiver Detector Output Check	56
4.3 Pre-Field Calibration	56
5.0 REFERENCES	56

LIST OF FIGURES

<u>Figure</u>	<u>Page</u>
4-1 Flowchart of Transmissometer Annual Maintenance Procedures	7
4-2 Optec LPV-2 Transmissometer Post-Field Inspection Checklist	9
4-3 Transmitter Control Box Circuit Board Components Diagram	12
4-4 Receiver Computer Front Panel Circuit Board Components Diagram	14
4-5 Power Supply Circuit Board Components Diagram	15
4-6 Bandpass Board Component Diagram	17
4-7 Receiver Computer Front Panel	18
4-8 Receiver Computer Output Test Fixture	20
4-9 Optec LPV-2 Transmissometer Post-Field Alignment Check Form	22
4-10 Transmitter Alignment Target	24
4-11 Optec LPV-2 Transmissometer Servicing Checklist	30

LIST OF FIGURES (CONTINUED)

<u>Figure</u>	<u>Page</u>
4-12 Optec LPV-2 Transmissometer Transmitter Lamp Voltage Measurements Record	38
4-13 CIMBUS D/A Converter Circuit Board Components Diagram	48
4-14 Optec LPV-2 Transmissometer Pre-Field Alignment Form	51

1.0 PURPOSE AND APPLICABILITY

This technical instruction (TI) describes annual laboratory servicing and preventative maintenance procedures for Optec LPV-2 transmissometers used in the IMPROVE network. The primary purpose of annual laboratory servicing is assure quality data capture by:

- Performing and documenting a post-field instrument inspection, functional test, and calibration on each transmissometer when it is returned from a field site.
- Performing and documenting the following annual transmissometer maintenance procedures:
 - Transmissometer disassembly and cleaning
 - Optics alignment checks and realignment
 - Chopper motor replacement
 - Instrument timing checks
 - Receiver computer gain measurements and calibration checks
 - Internal batteries replacement
 - Operational lamps replacement
 - Total system functional test
- Performing and documenting instrument upgrades and modifications as required.
- Performing a pre-field instrument calibration.

This TI, as referenced from Standard Operating Procedure (SOP) 4110, *Transmissometer Maintenance (IMPROVE Protocol)*, specifically describes transmissometer maintenance procedures to be performed during annual laboratory servicing of the Optec LPV-2 transmissometer systems.

2.0 RESPONSIBILITIES

2.1 PROJECT MANAGER

The project manager shall:

- Establish a servicing schedule to support annual replacement of transmissometers operating at field monitoring sites.
- Review servicing records prior to sending an instrument to a field monitoring site.
- Ensure that all instruments are serviced in accordance with the procedures described in this technical instruction.

2.2 INSTRUMENT TECHNICIAN

The instrument technician shall:

- Perform all laboratory servicing and maintenance procedures described in this TI.
- Document all servicing and maintenance work using the forms described in this TI.
- Maintain a file of all servicing records.
- Maintain the instrumentation laboratory spare parts inventory.

2.3 FIELD SPECIALIST

The field specialist shall:

- Perform transmissometer post-field and pre-field calibrations as specified in this technical instruction and in TI 4200-2100, *Calibration of Optec LPV-2 Transmissometers (IMPROVE Protocol)*.
- Provide technical support to the instrument technician in identifying and correcting instrument functional problems.

2.4 DATA COORDINATOR

The data coordinator shall provide the instrument technician with a description of any instrument problems suspected or identified during the time the instrument operated in the field.

3.0 REQUIRED INSTRUMENTATION, TOOLS, EQUIPMENT, AND MATERIALS

Specific instrumentation, tools, equipment, and materials required for transmissometer servicing include:

- Electronics laboratory instrumentation
- Optical laboratory equipment and instrumentation
- Specialized transmissometer servicing support equipment
- Cleaning and servicing supplies
- Hand tools
- Servicing forms and instrument manuals

3.1 ELECTRONICS LABORATORY INSTRUMENTATION

Specific instrumentation for the electronics laboratory includes:

- Digital voltmeter (4 1/2 digit display)

- Digital voltmeter (3 1/2 digit display, 3 amp current measurement capability)
- Dual channel oscilloscope (20 MHz bandwidth)
- Regulated power supply (12 VDC @ 10 amps)
- Adjustable regulated power supply (0-15 VDC @ 3 amps)

3.2 OPTICAL LABORATORY EQUIPMENT AND INSTRUMENTATION

Specific equipment and instrumentation for the optical laboratory includes:

- Optical bench and accessories including:
 - Optical bench (1 meter, low profile)
 - Detector head alignment fixture
 - Rod mount carriers (5)
 - Standard bench rods (4)
 - Vertical feed rod (1)
 - Beam diverter
- Controllable light source including:
 - Lamp monitor and control
 - Spectral irradiance head
 - Mask (0.020 inch pin-hole)
- Camera lens (135 mm) and holder
- Receiver computer emulator

3.3 SPECIALIZED TRANSMISSOMETER SERVICING SUPPORT EQUIPMENT

Specific support equipment for transmissometer servicing includes:

- Weighted detector head servicing fixture
- Transmitter bench stand
- Receiver computer output test fixture
- Reference detector head
- Chopper motor exchange stand

- Detector head emulator
- Celestron C11 Telescope Tripod with Optec alti-azimuth base
- Spotting scope
- IBM PC-compatible computer terminal (network access to PROCOMM communications software)
- CIMBUS computer servicing accessories including:
 - Serial communications interface card
 - PC board extender card

3.4 CLEANING AND SERVICING SUPPLIES

Specific supplies for cleaning and servicing a transmissometer system include:

- Electronics degreaser
- General purpose contact cleaner
- Flux remover
- Gold contact cleaner and lubricant (for gold edge connectors)
- Canned air
- Liquid window glass cleaner
- Isopropyl alcohol
- Heavy duty silicone lubricant
- Foam-tip swabs
- Paper towels
- Kimwipes (low linting tissue)
- Microfiber optical cleaning cloth and gloves
- Black silicone (room temperature vulcanizing)
- Electrical tape
- Pen or pencil
- Plastic bags (large and small)

- Cloth storage bags
- Rubber bands
- 6 V lithium batteries (2)
- AGC 5A fuse
- AGC 1A fuse

3.5 HAND TOOLS

Specific hand tools required for servicing a transmissometer system include:

- Small, medium, and large flat-blade screwdriver
- Small and medium Phillips-head screwdriver
- Small and medium adjustable wrench
- Allen wrench set
- Small wire cutter and stripper
- Pliers (standard, needle nose, and long nose)
- Nut driver set (1/4" - 1/2")
- Alignment tool (flat-blade tip)
- Contact extraction tool (for Amp Series 1 circular plastic connectors)
- T9 Torx driver
- Flexible pick-up tool
- Tape measure
- Soldering station

3.6 SERVICING FORMS AND INSTRUMENT MANUALS

The following servicing forms and checklists are required when performing annual servicing of the Optec LPV-2 transmissometer:

- Optec LPV-2 Transmissometer Post-Field Inspection Checklist
- Optec LPV-2 Transmissometer Post-Field Alignment Check Form
- Optec LPV-2 Transmissometer Servicing Checklist

- Optec LPV-2 Transmissometer Transmitter Lamp Voltage Measurements Record
- Optec LPV-2 Transmissometer Pre-Field Alignment Form
- Transmitter alignment target

The following instrument manuals and TIs are required for annual servicing of the Optec LPV-2 transmissometer:

- *Model LPV Long Path Visibility Transmissometer, Technical Manual for Theory of Operation and Operating Procedures*
- *CIMBUS Hardware Reference Manuals*
- TI 4200-2100, *Calibration of Optec LPV-2 Transmissometers (IMPROVE Protocol)*
- TI 4110-3400, *Annual Laboratory Maintenance Procedures for Optec LPV-2 Transmissometer Systems (IMPROVE Protocol)*

4.0 METHODS

This section includes three (3) major subsections:

- 4.1 Post-Field Inspection, Test, and Calibration
- 4.2 Annual Servicing
- 4.3 Pre-Field Calibration

Figure 4-1 is a flowchart showing the major procedures performed in each of these categories.

4.1 POST-FIELD INSPECTION, TEST, AND CALIBRATION

Each transmissometer returned from a field site for annual laboratory maintenance is inspected and tested prior to initiating any servicing procedures that could invalidate the instrument calibration. Post-field inspection and test is performed immediately after the instrument is received at ARS and includes:

- Initial inspection and functional tests.
- Detector uniformity check and post-field calibration.
- Post-field alignment check.

The procedures for performing these tasks are described in the following subsections.

ANNUAL SERVICING, FUNCTIONAL CHECKS,
 & PRE-FIELD CALIBRATION

POST FIELD INSPECTION,
 FUNCTIONAL CHECKS, & CALIBRATION

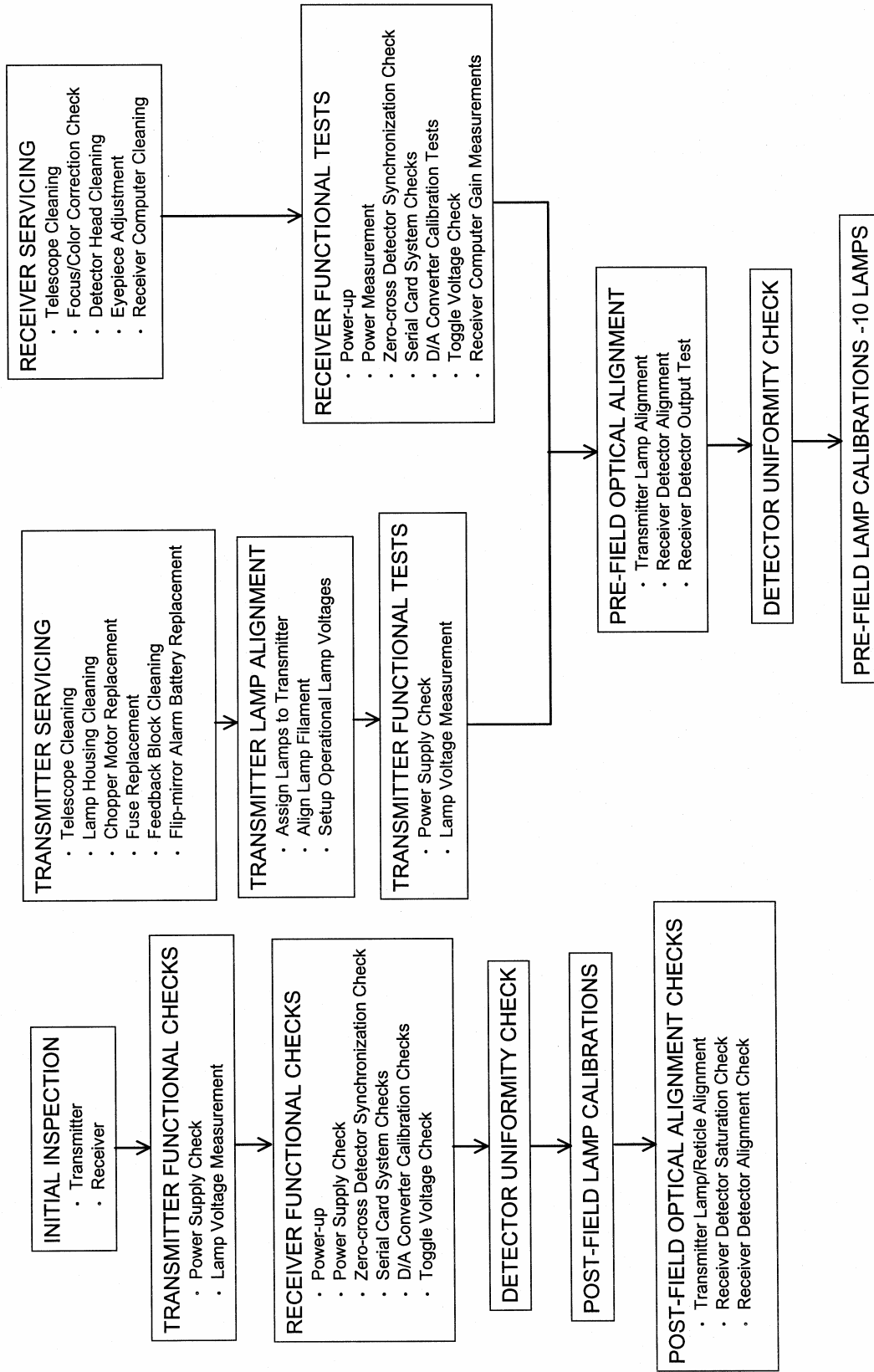

Figure 4-1. Flowchart of Transmissometer Annual Maintenance Procedures.

4.1.1 Initial Inspection and Functional Tests

The Optec LPV-2 Transmissometer Post-Field Inspection Checklist (Figure 4-2), is used by the instrument technician to document all initial inspection and functional test results. Initial inspection and test procedures are to be performed whenever an instrument is returned from the field. Procedures for performing and documenting the specified inspections and tests are described below.

4.1.1.1 Initial Inspection

GENERAL INFORMATION

Fill in the instrument number (LPV#), site abbreviation where the instrument last operated, date work was performed, and your name.

Note the reason the instrument was returned from the field. Describe any operational or functional problems noted by the site operator.

Examine the shipping cases for damage that might affect the instrument. Note the condition of the hinges and locks.

Note if the instrument components were packed in the protective plastic bags and cloth shipping bags.

Document the serial number and condition of each lamp returned with the instrument.

NOTE!! Do not clean the instrument or perform any service procedures during initial inspection.

TRANSMITTER INSPECTION

Check the transmitter telescope to see if the instrument was returned with a lamp installed. Note the lamp serial number.

Check the telescope Allen screws and the lamp base Torx screws for tightness.

Turn the flip mirror to the "ON" position and verify that the alarm is functioning.

Describe the "as returned" condition of all instrument components. Note cleanliness, cable and connector condition, and check for signs of battery leakage around the battery holders in the control box.

Measure the voltage of the AA backup batteries (should be approximately 6.0 volts).

**OPTEC LPV-2 TRANSMISSOMETER
 POST-FIELD INSPECTION CHECKLIST**

_____ Instrument _____ Number: _____
 _____ Site: _____
 _____ Date: _____
 _____ Technician: _____

Received for: Annual Servicing Unscheduled Maintenance
 Reason for Unscheduled Maintenance: _____

Shipping Case Condition: _____
 Protective Bags Used: _____

Lamps Received:	Lamp #	Condition	Lamp #	Condition	Lamp #	Condition
	_____	_____	_____	_____	_____	_____
	_____	_____	_____	_____	_____	_____
	_____	_____	_____	_____	_____	_____
	_____	_____	_____	_____	_____	_____

NOTE: Do not service instrument during inspection.

TRANSMITTER INSPECTION

Returned with Lamp Installed? Yes No Lamp #: _____
 Are Allen Screws in Transmitter Body Tight? Yes No
 Flip Mirror Alarm Functioning: Yes No

Describe "As Returned" Condition of:
 Telescope Body _____
 Optics _____
 Cables/Connectors _____
 Control Box Circuit Board/Connectors _____
 Control Box Backup Batteries _____

RECEIVER INSPECTION

Flip Mirror Alarm Functioning: Yes No
 Receiver Computer Backup Batteries: Yes No
 Receiver Telescope Aperture: _____ mm

Describe "As Returned" Condition of:
 Telescope Body _____
 Optics _____
 Telescope Baffle _____
 Cable/Connectors _____
 Battery Holders _____
 CIMBUS Computer Connectors _____
 CIMBUS _____ Computer _____ Cards _____

Receiver Computer Switch Settings:
 Gain _____ Path _____ Cal _____
 A1 _____ A2 _____
 Int _____ Cycle _____

Figure 4-2. Optec LPV-2 Transmissometer Post-Field Inspection Checklist.

TRANSMITTER FUNCTIONAL CHECK

Install Reference Lamp Prior to Performing These Checks:

Lamp Serial Number: _____

Transmitter Current: _____ Amps Lamp Voltage: _____ Volts

Test Point Voltages: T1 _____ T2 _____ T3 _____ T4 _____ T5 _____

RECEIVER FUNCTIONAL CHECK

Receiver Computer Display

At Power Up (000 Expected): _____

One Minute Avg - Flip Mirror Up (000 Expected): _____

Receiver Power Tests

Input Voltage	+5V	+15V	-15V	TP1 High/Low	TP2 High/Low	A1 Output	Auto Reset	Receiver Current (Amps)
12V								
8V								
7V								
12V								

Comments: _____

Bandpass Board Synchronization Check: Pass Fail

Serial Card Tests

Function	Expected Result	Pass/Fail	Comment
Toggle	Toggle Lamp Blinking		
OR	OR Lamp Blinking		
Cal Switch	Actual Setting		
Path Switch	Actual Setting		
A1 Switch	C=0, B=1, VR=2		
A2 Switch	SD=0, CR=1		

D/A Converter Calibration Check

Function	Display	A1 (DVM)	A2 (DVM)
Zero			
Max			
Mid			

Toggle Voltage Test

Toggle

ON

OFF

Voltage (No Load)

Voltage (With Load)

Receiver Computer Gain Check

Emulator Switch Setting	RMS Input (mV)	A1 Output at Gain Switch Setting (mV)				
		100	300	500	700	900
2						
1						

Figure 4-2. (Continued). Optec LPV-2 Transmissometer Post-Field Inspection Checklist.

RECEIVER
INSPECTION

Turn the flip mirror to the "ON" position and verify that the alarm is functioning.

Measure the voltage of the AA backup batteries (should be approximate 6.0 volts).

Record the receiver telescope aperture size (engraved on the front of the telescope). If an aperture ring is installed on the instrument, note this and record the size of the aperture ring.

Describe the "as returned" condition of all instrument components. Note cleanliness, cable and connector condition, and check for signs of battery leakage around the battery holders on the receiver computer front panel.

Check the CIMBUS computer cards and cable connectors in the receiver computer. Verify that all cards are fully inserted into the card edge connectors and that all cable connections to the cards are secure.

RECEIVER
COMPUTER
SWITCH
SETTINGS

Document the "as returned" setting for each of the receiver computer switches specified on the inspection checklist.

4.1.1.2 Transmitter Functional Check

TRANSMITTER
POWER AND
VOLTAGE
MEASUREMENTS

All functional check measurements related to the transmitter are conducted with the instruments reference lamp installed. Record the lamp serial number.

Measure and record the transmitter operating current with the lamp on.

Measure and record the lamp voltage using the measurement pigtail on the control box cable.

Measure and record the T1, T2, T3, T4, and T5 test point voltages on the transmitter control box circuit board (see Figure 4-3, Transmitter Control Box Circuit Board Components Diagram).

4.1.1.3 Receiver Functional Check

RECEIVER
COMPUTER
SETUP

Connect the receiver detector head to the receiver computer and connect the receiver computer to a 0-12 VDC variable output power supply. Set the power supply output to 12 VDC. Set the "A1" switch to position **C** (raw readings), the "CYCLE" switch to **CONT** (continuous), and the "INTEG" switch to **1** (one minute).

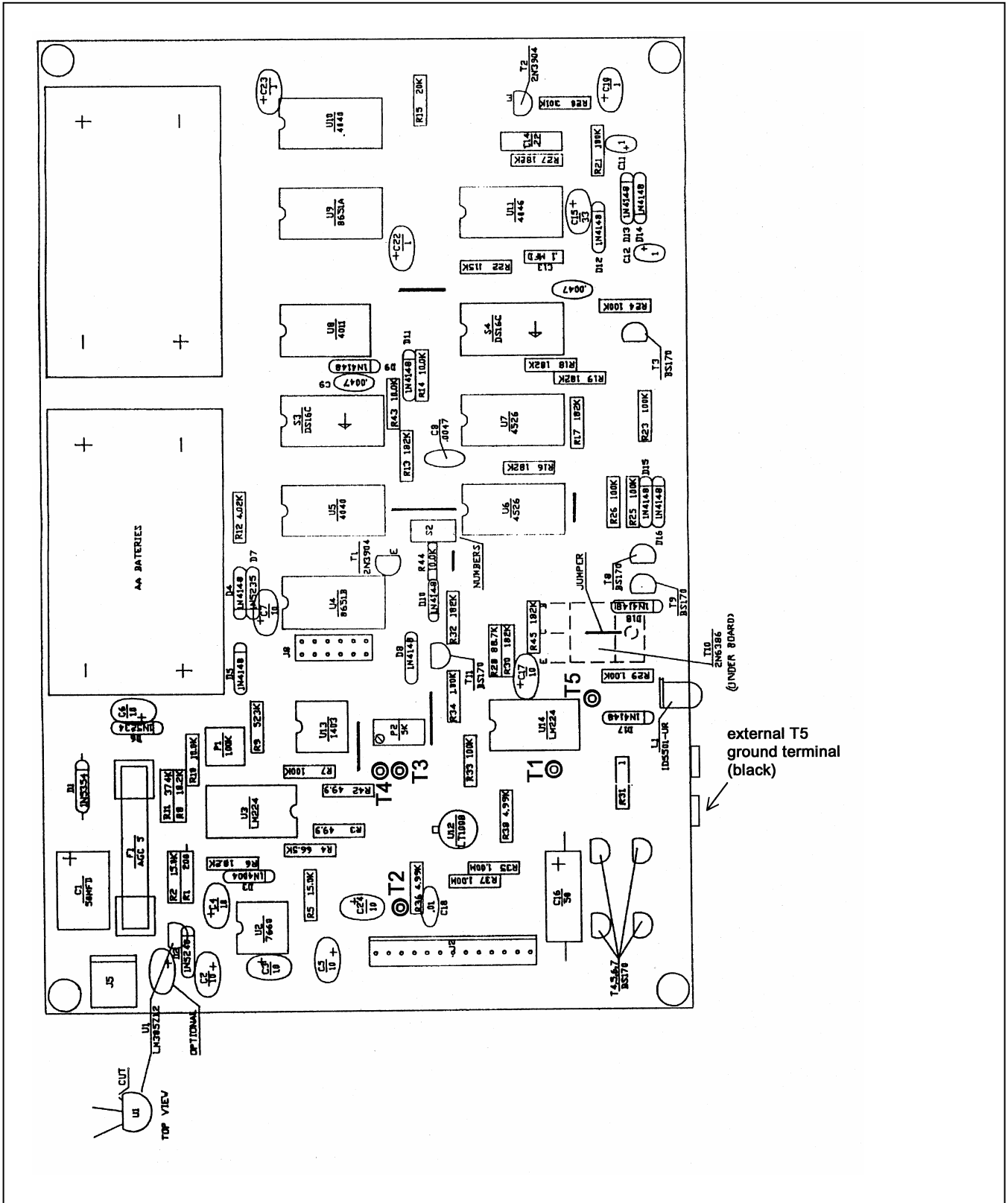

Figure 4-3. Transmitter Control Box Circuit Board Components Diagram.

Position the detector head so that it is "looking" at the transmitter lamp through a pin-hole mask. Adjust the detector head position so that the receiver computer will measure a one-minute raw readings average of 0.2 volts (200 on receiver computer display) or more.

Connect channel 1 and channel 2 of the oscilloscope to "TP1" and "TP2" of the auto reset circuit located on the receiver computer front panel board (see Figure 4-4, Receiver Computer Front Panel Circuit Board Components Diagram).

POWER-UP TEST

Turn the receiver computer **ON** and record the display reading immediately following the instruments power-up cycle.

ZERO INPUT TEST

Set the receiver telescope flip mirror to the "OFF" position (light blocked). Turn the receiver computer **OFF**, wait five (5) seconds and turn the receiver computer back **ON**. After one minute, the receiver computer will update the data on the front panel display. Since the flip mirror blocks all light from reaching the detector, the display should read "000." Record the display reading.

POWER SUPPLY AND AUTO RESET TEST

Place the receiver flip mirror in the "ON" position. With the power supply output set at 12 VDC, measure and record the receiver computer internal power supply outputs (+5 VDC, +15 VDC, -15 VDC). These voltages should be measured at the test points on the power supply board (see Figure 4-5, Power Supply Circuit Board Components Diagram). After the display updates, measure and record the "A1" output and the receiver operating current.

Reduce the external power supply voltage to 8.0 volts. After the next full one-minute update, record the "A1" output, the receiver power supply output voltages, and the "TP1" and "TP2" logic levels (high or low). This test confirms that the instrument will operate properly with a supply voltage as low as 8.0 volts.

Reduce the external power supply voltage to 7.0 volts. "TP1" and "TP2" should both go to a logic low. The receiver front panel display should be blank and the "A1" output should be zero. These conditions indicate that the receiver computer has ceased operation. Record the power supply output voltages, the "A1" output, and the "TP1" and "TP2" logic levels.

Increase the external power supply voltage to 12.0 volts. If the auto reset circuit is functioning properly, "TP1" and "TP2" will return to a logic high level immediately after the power supply voltage is increased. The "A1" output will be zero until the first update. After the update, the "A1" output will return to the value measured at the start of this test. At this time record the power supply output voltages, the "A1" output, and the "TP1" and "TP2" logic levels.

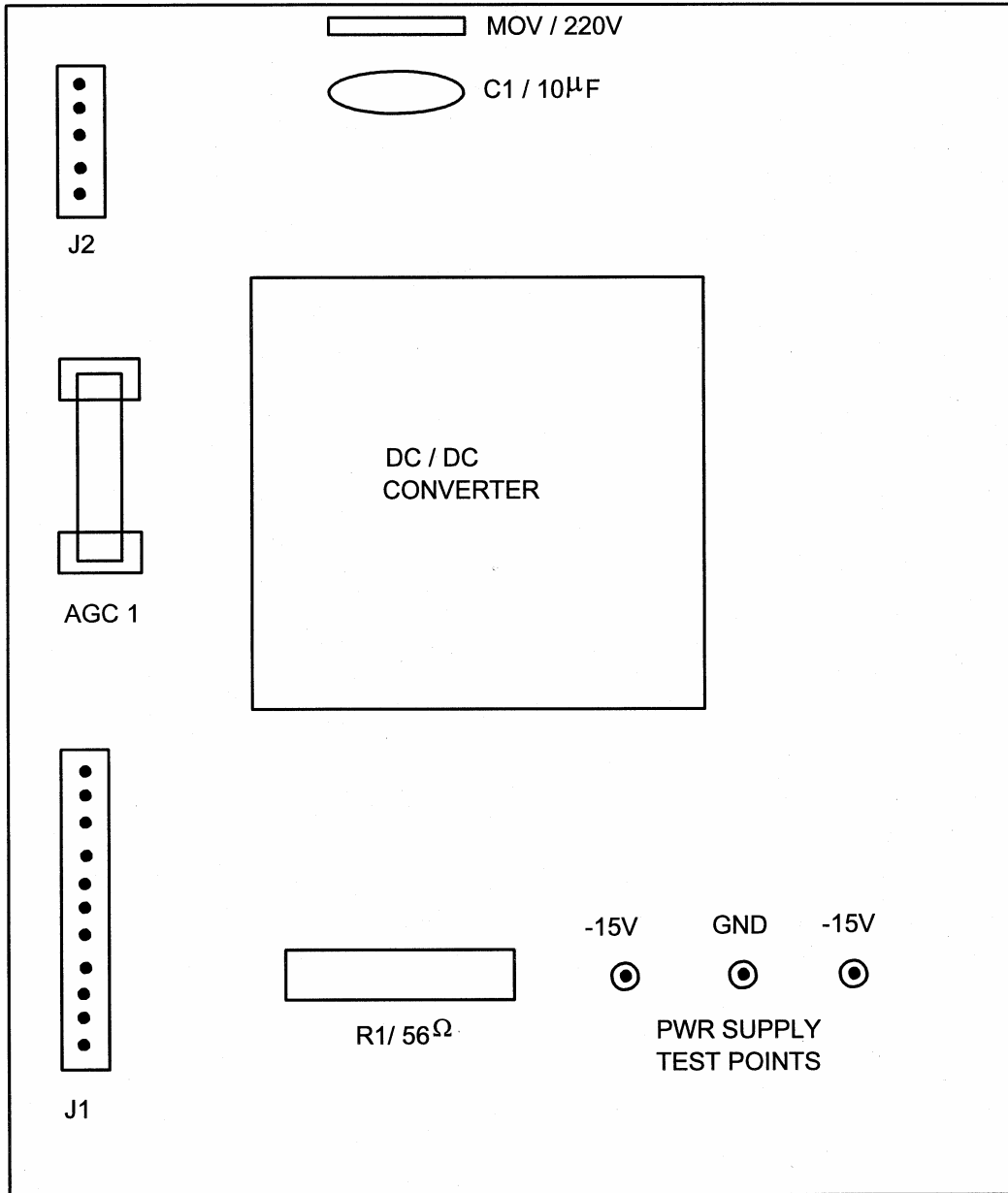

Figure 4-5. Power Supply Circuit Board Components Diagram.

ZERO-CROSS DETECTOR SYNCHRO- NIZATION CHECK

The purpose of this check is to determine if the receiver bandpass amplifier output is synchronized with the incoming transmitter signal. Connect channels 1 and 2 of the oscilloscope to test points "TP4" and "TP5" of the receiver computer bandpass board (see Figure 4-6, Bandpass Board Component Diagram). Synchronize the oscilloscope on channel 1. If the synchronization circuit is functioning properly, both the leading and trailing edges of the two waveforms will be in phase. If they are not in phase, mark the "FAIL" block and comment on the observed irregularity.

4.1.1.4 Serial Card Tests

SERIAL CARD TEST SETUP

Turn the receiver computer **OFF** and insert the CIMBUS serial card into slot #7 of the CIMBUS computer. Connect the serial card output to the serial port on the PC computer. PROCOMM software is used to communicate with the CIMBUS computer. Turn the receiver computer **ON** and enter **TEST** to initiate the receiver computer self-test program.

The "TEST" program will execute a fixed sequence of test routines that will check all major receiver computer functions. When one test is completed, hit any key to move to the next test in the sequence. The Receiver Computer Front Panel, Figure 4-7, shows the receiver computer front panel digital display, switches, and status lamps. Record the result (Pass/Fail) for each test listed below on the inspection checklist. If instrument fails any portion of a test, briefly describe the observed failure(s) under "Comments."

TOGGLE TEST

The "TOGGLE" lamp, located on the receiver computer front panel will blink continuously.

OVER RANGE (OR) TEST

The over range (OR), located on the receiver computer front panel will blink continuously.

CAL SWITCH TEST

The "CAL" switch is a three (3) digit thumbwheel switch located on the receiver computer front panel. The number set into this switch will be displayed on the computer screen. The number displayed on the screen will update each time any digit on the switch is changed. Verify that all 10 positions (0-9) for each digit are translated properly by the receiver computer.

PATH SWITCH TEST

The "PATH" switch is a four (4) digit thumbwheel switch located on the receiver computer front panel. Follow the switch test procedures described above for the "CAL" switch.

A1 SWITCH TEST

The "A1" switch is a 3-position rotary switch located on the front panel of the receiver computer. Set the "A1" switch to each of the three positions (C,B,VR). The "TEST" program will continuously read the switch setting and display the setting as a number (0=C, 1=B, 2=VR) on the computer screen. Verify that the number displayed matches the switch setting for each switch position.

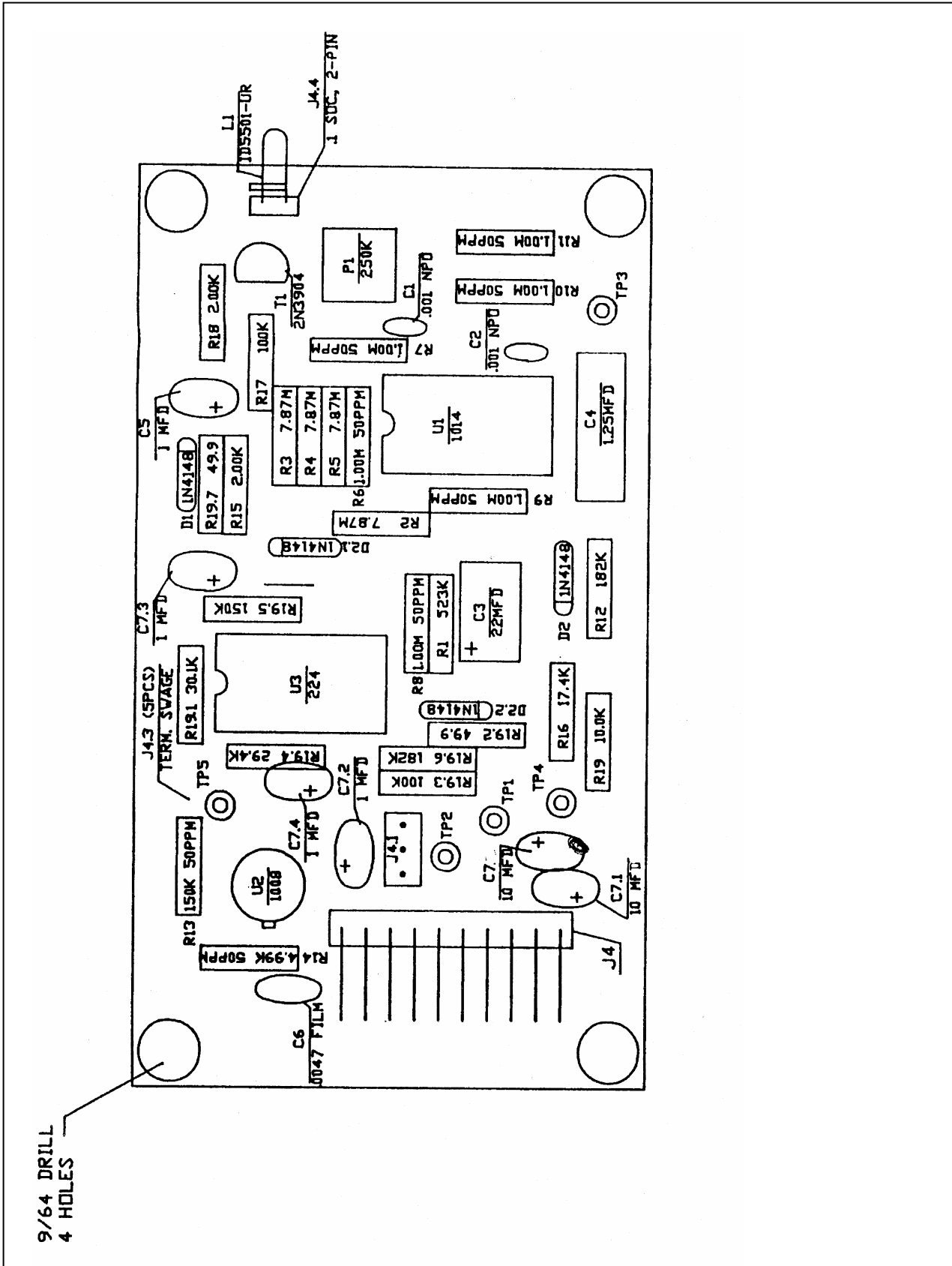

Figure 4-6. Bandpass Board Component Diagram.

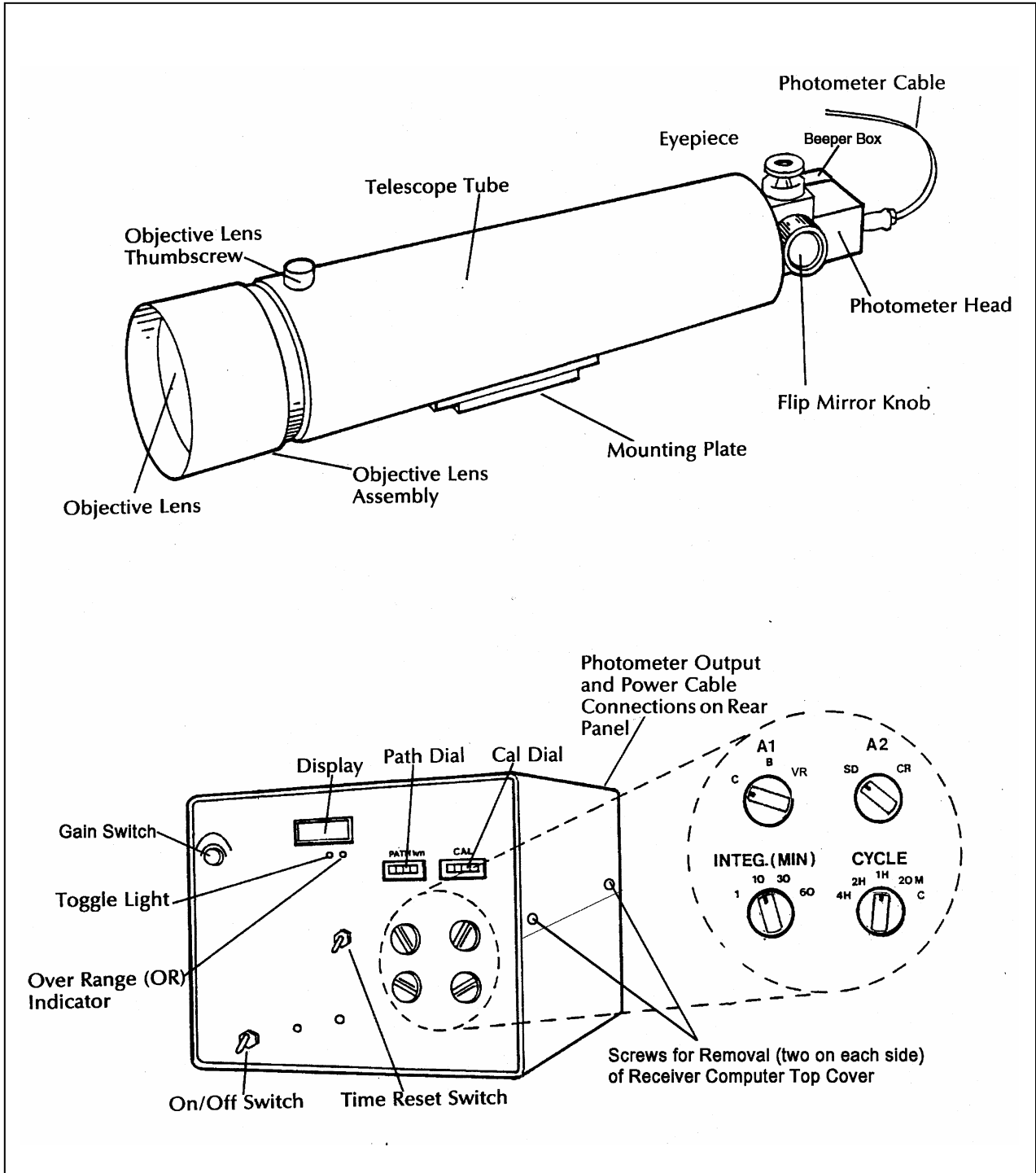

Figure 4-7. Receiver Computer Front Panel.

A2 SWITCH TEST

The "A2" switch is a two (2) position rotary switch located on the front panel of the receiver computer. Follow the procedures described above for testing the "A1" switch. The "A2" switch positions and the corresponding numbers displayed on the computer screen are "SD" (0) and "CR" (1).

ANALOG OUTPUT TEST

The receiver computer output test fixture includes a mating connector for the receiver computer output connector. This test fixture provides a switchable connection between the voltmeter and each of the receiver computer's two analog output signals (refer to Figure 4-8, Receiver Computer Output Test Fixture).

Turn the receiver computer **OFF** and remove the D/A converter board from the CIMBUS card cage. Insert the CIMBUS extender card in the D/A converter slot and plug the D/A converter into the extender card. Use the extension cables to make the connection from the wiring harness to the D/A connectors. Turn the receiver computer **ON**.

The "TEST" program provides three prompts indicating the test input applied to the D/A converters that generate the "A1" and "A2" output voltages. The test program also specifies the potentiometers to be adjusted for recalibration. It is important to not make any adjustments to the potentiometers during post-operational testing.

- ZERO - 0.00 volts
- MAX (Full scale) - 9.9975 volts
- MID (Half scale) - 4.9988 volts

The corresponding readings on the receiver computer display (for all "A1" switch positions) are as follows:

- ZERO - 000
- MAX (Full scale) - 1000
- MID (Half scale) - 500

Record the front panel display reading and the "A1" and "A2" output voltages for the specified switch settings.

4.1.1.5 Toggle Voltage Test

The receiver computer toggle output voltage is measured with and without an output load. The receiver computer output test fixture is used for this test. The "TOG-NL" (Toggle, no-load) position connects the toggle output directly to the voltmeter. The "TOG-L" (Toggle, with load) position connects a 4700 ohm resistor in parallel with the voltmeter input.

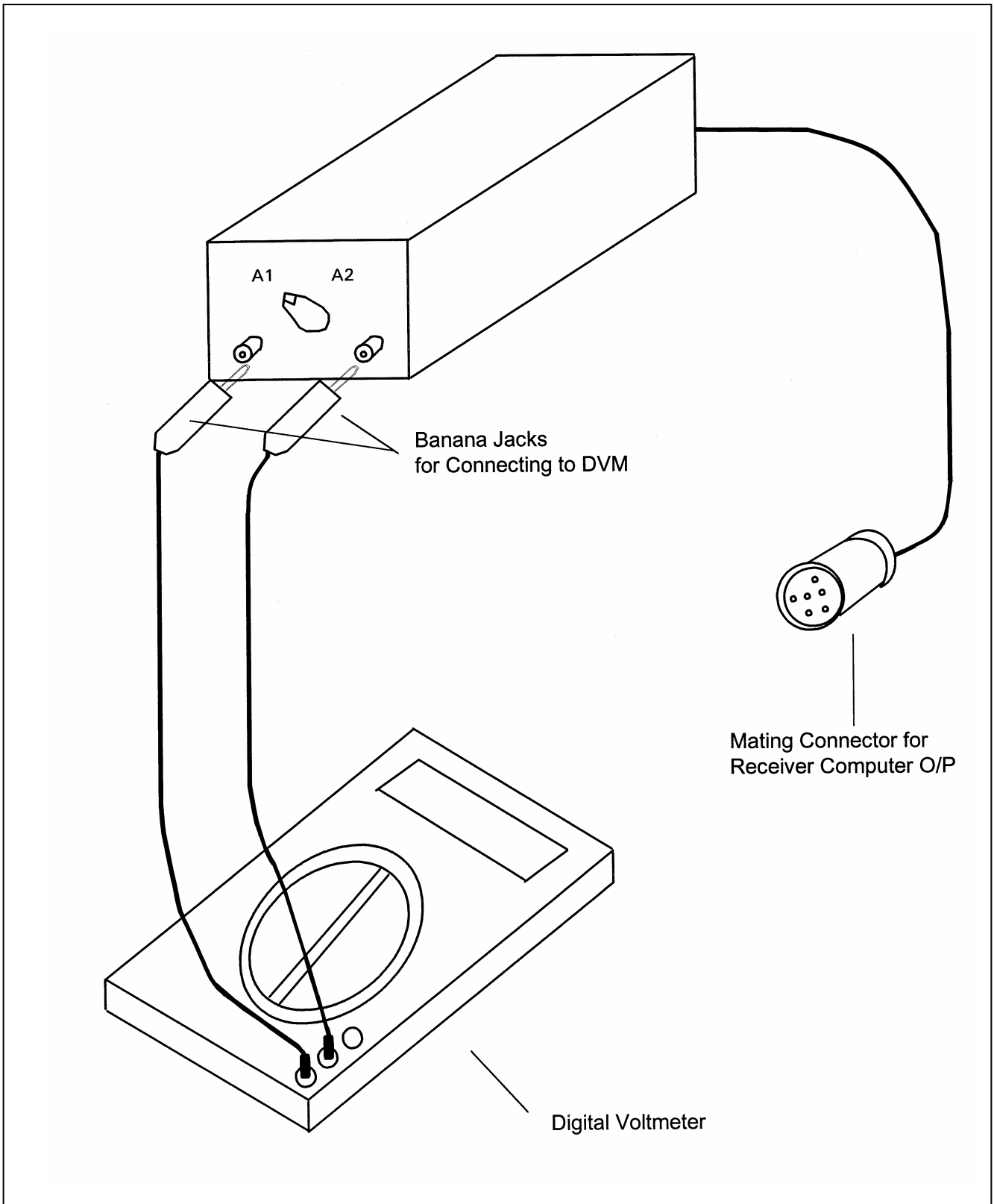

Figure 4-8. Receiver Computer Output Test Fixture.

Set the receiver computer for continuous operation ("CYCLE" switch on C) and one minute integrations ("INTEG" switch on 1). Measure the toggle output voltage in both the "TOG-NL" and "TOG-L" positions with the toggle lamp "ON." Wait one minute for the toggle lamp to switch "OFF" and repeat the measurements. Record the measured voltages for each set of conditions.

4.1.1.6 Receiver Computer Gain Test

Disconnect the detector head output cable from the receiver computer and connect the detector head emulator in its place. The detector head emulator is powered by the receiver computer and generates a low level square wave signal that emulates the detector head output response under operational conditions. Connect the receiver computer output test fixture to the receiver computer output connector. Set the emulator switch to position "2" and measure the emulator output voltage using an rms voltmeter. With the receiver computer set for continuous operation and one-minute integrations, measure the receiver computer output for gain switch settings of "100," "300," and "500." Record the emulator output voltage and the three receiver computer output voltages. Reset the emulator switch to position "1" and repeat the above procedure for gain switch settings of "700" and "900."

4.1.2 Detector Uniformity Check and Post-Field Calibration

A post-field calibration is performed with the primary reference lamp, the on-site reference lamp, and all unbroken operational lamps returned with the instrument. Detailed instructions for performing and documenting post-field calibrations are provided in TI 4200-2100, *Calibration of LPV-2 Transmissometers (IMPROVE Protocol)*.

4.1.3 Post-Field Alignment Check

The purpose of the post-field alignment check is to identify any change in either the transmitter lamp alignment and/or the receiver detector alignment during the time the instrument was operating in the field. Post-field alignment checks are performed after the post-field calibration and prior to servicing the instrument and include:

- Transmitter alignment check
- Receiver detector saturation check
- Receiver detector alignment check
- Receiver output detector check

All alignment checks and measurements should be documented on the Optec LPV-2 Transmissometer Post-Field Alignment Check Form, Figure 4-9.

4.1.3.1 Transmitter Alignment Check

This procedure requires an unobstructed sight path of at least 50 feet and the following equipment:

- Tripod with Optec alti-azimuth base
- Spotting scope mounted on a tripod

OPTEC LPV-2 TRANSMISSOMETER
POST-FIELD ALIGNMENT CHECK

Instrument Number: _____
Date: _____
Technician: _____

1. TRANSMITTER ALIGNMENT CHECK

Focus the transmissometer on the target (shown to the right of this paragraph) and tighten the objective lens securely. Adjust the transmitter so the beam is inside the large outer circle of the target. The target has two inner circles. The larger inner circle represents the outer limit for the reticle. The smaller inner circle represents the ideal reticle alignment and is indicated below. Draw the actual reticle position on the target.

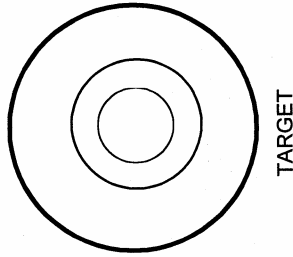

2. RECEIVER DETECTOR SATURATION CHECK

Test Detector - Camera Lens Aperture F/2.8 Reference Detector - Camera Lens Aperture F/4

Saturation Level: _____ Output Level: _____

3. RECEIVER DETECTOR ALIGNMENT CHECK

	<u>FULL RETICLE LIGHT BEAM</u>				
Alignment Position	1	2	3	4	5
Detector Output (V)	_____	_____	_____	_____	_____
	<u>1/4 RETICLE LIGHT BEAM</u>				
Alignment Position	1	6	7	8	9
Detector Output (V)	_____	_____	_____	_____	_____

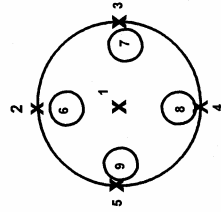

ALIGNMENT POSITIONS

4. RECEIVER DETECTOR OUTPUT CHECK

Adjust Light Source Intensity for a Reference Detector Output of Approximately 7.0 Volts

Reference Detector Output at Alignment Position 1: _____

Test Detector Output at Full Reticle Maximum Position: _____

postfld.sam (8/96)

Figure 4-9. Optec LPV-2 Transmissometer Post-Field Alignment Check Form.

- Transmitter alignment target (see Figure 4-10, Transmitter Alignment Target)
- DC Power Supply - 12 volts @ 5 amps

TRANSMITTER SETUP

Attach the transmitter alignment target to a wall at one end of the sight path. The center of the target should be at a height of approximately 42 inches. Attach the transmitter telescope to the tripod and set up the tripod 47 feet from the alignment target. Set up the spotting scope next to the transmitter telescope. Focus the transmitter telescope on the alignment target by adjusting the position of the objective lens. The objective lens is held in position by a set screw in the top of the telescope.

ADJUST ALIGNMENT

Connect the DC power supply to the transmitter control box and connect the control box to the transmitter telescope. Insert the reference lamp for the instrument being tested into the transmitter and turn the transmitter "ON." Use the spotting scope to observe the position of the transmitter light beam while adjusting the alti-azimuth base to center the light beam in the large outer circle of the alignment target. The transmitter reticle should align with the smaller of the two inner circles (refer to the target diagram on the Optec LPV-2 Transmissometer Post-Field Alignment Check Form, Figure 4-9). Alignment is acceptable if the reticle position is entirely within the larger of the two inner circles. Sketch the outline of the actual reticle position on the target diagram.

4.1.3.2 Receiver Detector Saturation Check

To determine the saturation level of the test instrument receiver detector, a variable intensity light source is focused on the detector. The detector output voltage is monitored as the light intensity is slowly increased. When the detector output voltage no longer increases with increasing light intensity, the saturation level has been reached.

This procedure requires the following test equipment:

- Optical bench
- Variable intensity light source
- Beam diverter
- 135 mm camera lens
- Detector head alignment fixture
- Receiver computer emulator
- Digital voltmeter (4 1/2 digit)
- Reference detector head

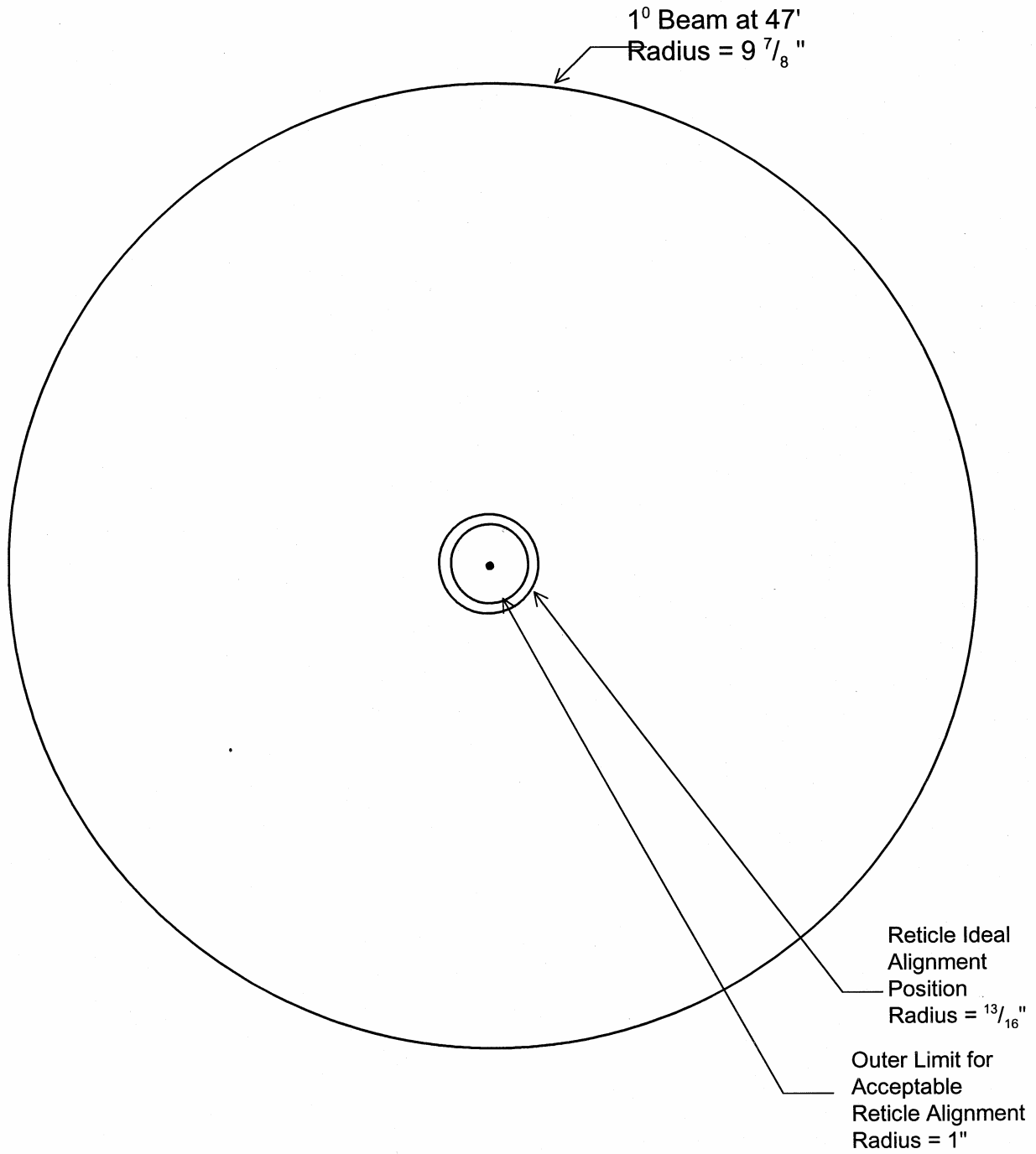

Figure 4-10. Transmitter Alignment Target.

INSTALL OPTICAL BENCH ACCESSORIES

Install the following optical bench accessories at the position shown:

- Variable intensity light source - 0.0 cm
- Beam diverter - 15.0 cm
- 135 mm camera lens - 37.5 cm
- Detector head alignment fixture - 55.5 cm

DETECTOR HEAD AND TEST EQUIPMENT SETUP

Set up the detector head and test equipment as follows:

- Install the detector head being tested on the detector head alignment fixture.
- Connect the detector head cable to the receiver computer emulator.
- Connect the digital voltmeter to the output of the receiver computer emulator.
- Remove the pin-hole mask from the light source filter holder.
- Set camera lens aperture at $f/2.8$
- Align the light beam at the center of the detector head.

MEASURE SATURATION LEVEL

Measure the saturation level of the transmissometer detector as follows:

- Slowly increase the light intensity to the point where the detector output voltage no longer increases. This voltage is typically in the range 13.0 to 14.5 volts DC. A saturation level lower than 11.5 volts indicates degradation of the detector response.
- Record this voltage (test detector saturation level) on the alignment check form.
- **NOTE: Do not change the intensity of the light source while performing the final steps of this procedure!**
- Remove the test instrument detector head from the alignment fixture and replace it with the reference detector head.
- Connect the reference detector head to the receiver computer emulator.
- Set the camera lens aperture at $f/4$.

- At this point, the digital voltmeter will be indicating the voltage output of the reference detector head. The reduced aperture will ensure that the reference detector is not saturated and permits a comparison of the relative light intensity required for detector saturation for all receiver detector heads.
- Record this voltage (reference detector output level) on the Optec LPV-2 Transmissometer Post-Field Alignment Check Form.

4.1.3.3 Receiver Detector Alignment Check

The receiver detector alignment check (part 3 of the Optec LPV-2 Transmissometer Post-Field Alignment Check Form) is performed in two stages. For the first stage, the size of the light beam projected onto the detector is adjusted to the diameter of the receiver reticle (full reticle light beam). The detector response is measured with the light beam centered in the reticle (position 1) and on the centered on the edge of the reticle at 0°, 90°, 180°, and 270° (positions 2-5). These alignment positions are shown on the drawing labelled "Alignment Positions" on the alignment form (Figure 4-9). The beam position is then scanned across the reticle to identify the position that provides the maximum output from the detector. Procedures for the second stage are similar to those described above with the light beam diameter adjusted to 1/4 of the reticle diameter (1/4 reticle light beam). Detector output measurements are obtained with the light beam centered in the reticle (position 1) and adjacent to the reticle at 0°, 90°, 180°, and 270° (positions 6-9). Document all measurements on the Optec LPV-2 Transmissometer Post-Field Alignment Check Form.

This procedure requires the following test equipment:

- Optical bench
- Variable intensity light source
- Beam diverter
- 135 mm camera lens
- Detector head alignment fixture
- Receiver computer emulator
- Digital voltmeter (4 1/2 digit)

OPTICAL BENCH SETUP

To perform the full reticle light beam alignment check, the optical bench should be setup with the following accessories installed at the position shown:

- Variable intensity light source - 0.0 cm
- Beam diverter - 15.0 cm
- 135 mm camera lens - 37.5 cm
- Detector head alignment fixture - 63.5 cm

DETECTOR
HEAD AND TEST
EQUIPMENT
SETUP

Set up the detector head and test equipment as follows:

- Install the detector head being tested on the detector head alignment fixture.
- Connect the detector head cable to the receiver computer emulator.
- Connect the digital voltmeter to the output of the receiver computer emulator.
- Place the pin-hole mask in the light source filter holder.
- Set camera lens aperture at f/2.8.

ADJUST
BEAM
DIVERTER

Turn the light source "ON" and adjust the beam diverter to center the light beam in the detector head reticle. If the light beam is slightly out of focus, adjust the position of the detector head alignment fixture as needed to bring the light beam into focus.

RECORD
OUTPUT
VOLTAGES

Using the beam diverter to adjust the light beam position, align the full reticle light beam to alignment positions 1-5 as indicated on the alignment check form. Record the detector output voltage at each position. Then, align the light beam for maximum detector output voltage. Mark an "X" on the alignment positions diagram to indicate the position of the maximum output. Document the output voltage measured at this position (full reticle maximum detector output voltage) on the alignment check form.

CHANGE
SETUP

Prior to performing the 1/4 reticle alignment check, the optical bench setup must be changed as follows:

- Position the 135 mm camera lens at 55.5 cm
- Position the detector head alignment fixture at 65.0 cm
- Set the camera lens aperture at f/4.

RECORD
OUTPUT
VOLTAGES

Align the 1/4 reticle light beam to alignment positions 1-5 as indicated on the alignment check form and record the detector output voltage at each position.

4.1.3.4 Receiver Detector Output Check

The receiver detector output check establishes a relative output relationship between the test detector head and the reference detector head. The light source intensity is adjusted to provide a specified output voltage from the reference detector. The test detector is then subjected to the same light source under the same conditions and its output voltage documented. Since instruments are serviced on an annual basis, this output check provides a history of the detector sensitivity.

The initial setup for the optical bench and test equipment is the same for this check as for the full reticle alignment check. Procedures for performing the output check are as follows:

- Center the light beam in the reference detector head reticle (align to alignment position 1).
- Adjust the light intensity for a detector output voltage of approximately 7.0 volts.
- Document the actual output voltage of the reference detector head.
- Replace the reference detector head with the test detector head.
- Without adjusting the light intensity, align the light beam to obtain the maximum output voltage from the test detector head. Document this voltage on the alignment check form.

4.2 ANNUAL SERVICING

Annual servicing of LPV-2 transmissometers includes a series of preventative maintenance and optical alignment tasks performed following completion of post-field inspection and functional checks, post-field lamp calibrations, and post-field alignment checks. Service forms required for annual servicing include:

- Optec LPV-2 Transmissometer Servicing Checklist.
- Optec LPV-2 Transmissometer Pre-Field Alignment Form.
- Optec LPV-2 Transmissometer Transmitter Lamp Voltage Measurements Record.

Specific tasks performed during annual servicing include:

- Transmitter servicing.
- Transmitter functional tests.
- Receiver servicing.
- Receiver computer functional tests.
- Transmitter/receiver optical alignment.

Detailed procedures for performing these tasks are described in the following subsections.

4.2.1 Transmitter Servicing and Functional Tests

Servicing of the LPV-2 transmitter includes:

- Cleaning of the control box, telescope and lamp housing, all optical components, and all electrical connections.
- Physical adjustment and alignment of optical components.

- Replacement of expendable electrical components.
- Alignment and voltage setup of transmitter lamps.
- Functional testing.

The Optec LPV-2 Transmissometer Servicing Checklist, Figure 4-11, is a four-page form used to document transmitter servicing tasks performed. Procedures for performing and documenting specific tasks are described below.

4.2.1.1 Transmitter Telescope and Lamp Housing

Document the completion of the following service tasks on page 1 of the Optec LPV-2 Transmissometer Servicing Checklist.

GENERAL INFORMATION

Complete the general information section of the service form. If the instrument is being serviced following failure or malfunction while operating in the field, check the box marked "other" and note the operational problem(s) in the "Comments" section.

TRANSMITTER SERVICING

Place the transmitter on the transmitter bench stand and clean the outside of the transmitter with window cleaner and paper towels.

Remove the transmitter objective lens and clean the lens with an optical cleaning cloth.

Remove the telescope tube by loosening the two set screws located in the top and side of the transmitter mounting plate at the rear of the telescope tube.

Using Kimwipes held in the jaws of a flexible pickup tool, clean the inside of the transmitter telescope. Wipe back and forth to remove all contaminants. Use canned air to blow any remaining particles from the inside of the tube.

BAFFLE

Check that the baffle is securely mounted. If it is not, remount it using black RTV silicone.

Measure and record the baffle distance (in inches) from the front of the tube.

REINSTALL TELESCOPE

Reinstall the telescope tube on the mounting plate. Firmly tighten both set screws.

Reinstall the objective lens and firmly tighten the set screw.

EYEPIECE CLEANING AND ADJUSTMENT

Unscrew and remove the eyepiece lens. Clean both sides of the lens with an optical cleaning cloth.

Clean the eyepiece tube with canned air and replace the lens (finger-tight).

**OPTEC LPV-2 TRANSMISSOMETER
SERVICING CHECKLIST**

Instrument Number: _____
Date: _____
Technician: _____

Annual Servicing Other Comments: _____

TRANSMITTER SERVICING

Transmitter Telescope and Lamp Housing

Completed See Comment

- | | | |
|--------------------------|--------------------------|---|
| <input type="checkbox"/> | <input type="checkbox"/> | Clean outside of transmitter |
| <input type="checkbox"/> | <input type="checkbox"/> | Remove and clean both sides of objective lens |
| <input type="checkbox"/> | <input type="checkbox"/> | Clean inside of telescope tube |
| <input type="checkbox"/> | <input type="checkbox"/> | Measure baffle distance from front of telescope - _____ inches |
| <input type="checkbox"/> | <input type="checkbox"/> | Replace objective lens and tighten securely |
| <input type="checkbox"/> | <input type="checkbox"/> | Clean both sides of eyepiece lens |
| <input type="checkbox"/> | <input type="checkbox"/> | Adjust the eyepiece |
| <input type="checkbox"/> | <input type="checkbox"/> | Remove the chopper (Mark date removed and Instrument # on old chopper motor). |
| <input type="checkbox"/> | <input type="checkbox"/> | Clean internal connectors & check tightness |
| <input type="checkbox"/> | <input type="checkbox"/> | Clean and lubricate the lamp bushing |
| <input type="checkbox"/> | <input type="checkbox"/> | Install feedback block filter retainer (if not already installed) |
| <input type="checkbox"/> | <input type="checkbox"/> | Clean and inspect the feedback block |
| <input type="checkbox"/> | <input type="checkbox"/> | Clean lamp chamber with canned air |
| <input type="checkbox"/> | <input type="checkbox"/> | Install new chopper motor/blade assembly (Mark installation date). |
| <input type="checkbox"/> | <input type="checkbox"/> | Affix green ON and red OFF labels to flip mirror knob |
| <input type="checkbox"/> | <input type="checkbox"/> | Clean and lubricate exterior connectors |
| <input type="checkbox"/> | <input type="checkbox"/> | Affix "Do Not Change Focus" sticker to telescope |
| <input type="checkbox"/> | <input type="checkbox"/> | Install new flip mirror alarm battery |
| <input type="checkbox"/> | <input type="checkbox"/> | Check body Allen screws - tighten as needed |
| <input type="checkbox"/> | <input type="checkbox"/> | Secure mirror knob - cover for storage with plastic and cloth bags |

Comments: _____

Figure 4-11. Optec LPV-2 Transmissometer Servicing Checklist.

Transmitter Control Box

Completed See Comment

- | | | |
|--------------------------|--------------------------|--|
| <input type="checkbox"/> | <input type="checkbox"/> | Clean exterior of control box |
| <input type="checkbox"/> | <input type="checkbox"/> | Clean and lubricate exterior connectors |
| <input type="checkbox"/> | <input type="checkbox"/> | Check connectors, socketed ICs, and jumpers |
| <input type="checkbox"/> | <input type="checkbox"/> | Replace U3 and U14 (LM 124) |
| <input type="checkbox"/> | <input type="checkbox"/> | Clean and check battery holders |
| <input type="checkbox"/> | <input type="checkbox"/> | Clean and check internal connector tightness |
| <input type="checkbox"/> | <input type="checkbox"/> | Replace fuse F1 (AGC 5 amp fast blow) |
| <input type="checkbox"/> | <input type="checkbox"/> | Check labeling on test point T1-T5 and fuse. Re-label with permanent marker if required |
| <input type="checkbox"/> | <input type="checkbox"/> | Update revision sticker |
| <input type="checkbox"/> | <input type="checkbox"/> | Clean inside of control box and reinstall cover |
| <input type="checkbox"/> | <input type="checkbox"/> | Cover for storage with cloth bag |
| <input type="checkbox"/> | <input type="checkbox"/> | Install measurement pigtail on transmitter end of control box cable (if not already installed) |
| <input type="checkbox"/> | <input type="checkbox"/> | Clean cable connectors and coil cable for storage |

Comments: _____

Transmitter Lamp Alignment

Completed See Comment

- | | | |
|--------------------------|--------------------------|---|
| <input type="checkbox"/> | <input type="checkbox"/> | Refocus transmitter objective lens at infinity and tighten securely |
| <input type="checkbox"/> | <input type="checkbox"/> | Assign operational lamps to transmitter |
| <input type="checkbox"/> | <input type="checkbox"/> | Adjust lamp base plate for proper lamp filament alignment |
| <input type="checkbox"/> | <input type="checkbox"/> | Adjust feedback block position for proper lamp filament focus |
| <input type="checkbox"/> | <input type="checkbox"/> | Check clearance between lamps and feedback block |
| <input type="checkbox"/> | <input type="checkbox"/> | Setup operational lamp voltages |

Comments: _____

TRANSMITTER FUNCTIONAL TEST

Install Reference Lamp Prior to Performing These Tests:

Lamp Serial Number: _____

Transmitter Current: _____ Amps Lamp Voltage: _____ Volts

Test Point Voltages: T1 _____ T2 _____ T3 _____ T4 _____ T5 _____

Figure 4-11. (Continued). Optec LPV-2 Transmissometer Servicing Checklist.

RECEIVER SERVICING

Receiver Telescope Servicing

<u>Completed</u>	<u>See Comment</u>	
<input type="checkbox"/>	<input type="checkbox"/>	Clean telescope exterior
<input type="checkbox"/>	<input type="checkbox"/>	Remove objective lens and clean both surfaces
<input type="checkbox"/>	<input type="checkbox"/>	Record aperture diameter (from aperture ring) - Aperture _____
<input type="checkbox"/>	<input type="checkbox"/>	Check baffle location (9-1/4")
<input type="checkbox"/>	<input type="checkbox"/>	Check wedge base for tightness
<input type="checkbox"/>	<input type="checkbox"/>	Clean inside of the telescope tube
<input type="checkbox"/>	<input type="checkbox"/>	Replace objective lens and re-focus at infinity
		Focus Quality: Good <input type="checkbox"/> Fair <input type="checkbox"/> Poor <input type="checkbox"/>
		Color Correction: Good <input type="checkbox"/> Fair <input type="checkbox"/> Poor <input type="checkbox"/>
<input type="checkbox"/>	<input type="checkbox"/>	Cover for storage with plastic and cloth bags

Comments: _____

Receiver Detector Head Servicing

<u>Completed</u>	<u>See Comment</u>	
<input type="checkbox"/>	<input type="checkbox"/>	Clean detector head exterior
<input type="checkbox"/>	<input type="checkbox"/>	Clean both sides of eyepiece lens
<input type="checkbox"/>	<input type="checkbox"/>	Adjust eyepiece
<input type="checkbox"/>	<input type="checkbox"/>	Clean connector
<input type="checkbox"/>	<input type="checkbox"/>	Affix the green ON and red OFF labels to flip mirror knob
<input type="checkbox"/>	<input type="checkbox"/>	Install new flip mirror alarm battery
<input type="checkbox"/>	<input type="checkbox"/>	Secure flip mirror knob in ON position
<input type="checkbox"/>	<input type="checkbox"/>	Cover for storage with plastic and cloth bags

Comments: _____

Receiver Computer Servicing

<u>Completed</u>	<u>See Comment</u>	
<input type="checkbox"/>	<input type="checkbox"/>	Clean outside of computer
<input type="checkbox"/>	<input type="checkbox"/>	Clean inside of computer with canned air
<input type="checkbox"/>	<input type="checkbox"/>	Remove computer cards and clean all connector contacts
<input type="checkbox"/>	<input type="checkbox"/>	Reinstall computer card connectors, and rubber band hold-downs
<input type="checkbox"/>	<input type="checkbox"/>	Clean bandpass board with canned air
<input type="checkbox"/>	<input type="checkbox"/>	Clean and check power module connector contacts
<input type="checkbox"/>	<input type="checkbox"/>	Check labeling on power supply test points and fuse type
<input type="checkbox"/>	<input type="checkbox"/>	Replace power supply fuse (AGC 1 amp fast blow)
<input type="checkbox"/>	<input type="checkbox"/>	Clean and lubricate exterior connectors

Comments: _____

Figure 4-11. (Continued). Optec LPV-2 Transmissometer Servicing Checklist.

Adjust the eyepiece vertical position. Loosen the two set screws that hold the eyepiece in place. Align the bottom of the black band on the eyepiece with the top of the eyepiece holder and tighten the set screws.

LAMP HOUSING SERVICING

Place the transmitter on the chopper motor exchange stand and remove the lamp housing top and bottom cover plates.

Remove the chopper motor control wires at the transmitter input connector. An AMP pin extractor is required for this procedure.

Loosen the two set screws that hold the chopper motor in place and remove the chopper motor. NOTE: Do not install a replacement chopper motor at this point in servicing.

Clean the internal connectors with contact cleaner. Inspect the tightness of the connector pins. Tighten as required.

Clean the lamp bushing using electronic degreaser on a foam-tip swab followed by rubbing alcohol on a foam-tip swab.

Lubricate the inside surface of the lamp bushing with silicone lubricant on a foam-tip swab.

Clean the inside of the side plates with electronic degreaser and Kimwipes.

FEEDBACK BLOCK SERVICING

Remove the feedback block. This requires desoldering the photodetector from the photometer circuit board.

If the detector module is fastened to the feedback block with glue, the detector module should be removed and reinstalled after modification for use with the detector module retaining ring. Note under the "comments" section if the retaining ring modification was implemented.

Clean the feedback block optics with an optical cleaning cloth. Inspect the feedback block and note any hazing on the inside surfaces of the lenses.

Reinstall the feedback block and resolder the photodetector leads to the photometer circuit board.

CHOPPER MOTOR REPLACEMENT

Install a new chopper motor using the following procedures:

- The motor wires exit the back of the motor. The wire that exits nearest the green dot on the motor label should be marked with white shrink tubing.
- Insert the motor in the motor cavity with the motor positioned so the motor wires exit the motor cavity at the cutout.

- Tighten the two set screws that hold the chopper motor in place. The set screw on the right should be tightened first to ensure that the motor is positioned properly.
- Insert the marked motor wire into pin position 7 of the input connector. Insert the unmarked wire into pin position 8.
- Tape the motor wires to the front plate of the lamp housing so they do not interfere with the chopper blade.
- Replace the lamp housing bottom plate.
- Blow all dust and other particles out of the lamp chamber with canned air.
- Replace the lamp housing top plate.

FLIP MIRROR SERVICING

Check the "ON" (green) and "OFF" (red) labels on the flip mirror control knob. Replace if damaged or missing.

Replace the flip mirror alarm battery using the following procedures:

- Remove the four (4) screws that hold the end plate in place.
- Remove the set screw that holds the speaker screen in place.
- Remove the speaker screen and the sound tube.
- Slide the printed circuit board out of the alarm enclosure.
- Desolder the old battery. Obtain a new battery (BR-2325-2 HC) and solder it onto the circuit board.
- Slide the circuit board back into the enclosure, replace the sound tube and speaker screen, tighten the speaker screen set screw, and replace the end plate.

FINAL ITEMS

Clean the outside of the transmitter input connector with contact cleaner. Lubricate the plastic shell with silicone lubricant.

Affix a "DO NOT CHANGE FOCUS" label to the telescope tube immediately below the objective lens adjustment slot.

Tighten all body screws.

Secure the flip mirror in the "ON" position (alarm off) with a rubber band.

Cover the lamp housing and eyepiece with a large plastic bag. Cover the end of the telescope tube with a small plastic bag. Use rubber bands to hold the plastic bags in place.

Place the entire transmitter telescope and lamp housing in a clean white cloth transmitter storage bag.

4.2.1.2 Transmitter Control Box

Document the completion of the following service tasks on page 2 of the Optec LPV-2 Transmissometer Servicing Checklist.

EXTERIOR CLEANING

Clean the outside of the control box with window cleaner and paper towels.

Clean all exterior connectors with contact cleaner. Apply silicone lubricant to the plastic connector shells.

INTERNAL INSPECTION, COMPONENT REPLACEMENT, AND CLEANING

Remove the control box cover plate and interior shield.

Inspect all internal connectors, jumpers, and socketed components for proper location and tight connections. Clean the connectors with contact cleaner.

Replace U3 and U14 (located on the control box circuit board - refer to Figure 4-3) with new LM124 ICs.

Inspect the battery clips for cold solder joints and repair as needed. Clean the battery clip contacts with contact cleaner.

Replace Fuse F1 (AGC 5A fast blow).

Relabel test points and fuse type if needed.

Update revision sticker.

Spray the inside of the control box with canned air to remove dust and other particles.

Replace the internal shield and cover plate.

Place the control box in a clean white cloth storage bag.

CONTROL BOX CABLE

Check integrity of connectors on control box cable and measurement pigtail. Install a measurement pigtail if cable has not been modified.

Clean connectors with contact cleaner.

Coil cable for storage.

4.2.1.3 Transmitter Lamp Alignment and Voltage Setup

Document the completion of the following lamp alignment procedures on page 2 of the Optec LPV-2 Transmissometer Servicing Checklist. Lamp setup voltages should be documented on the Optec LPV-2 Transmissometer Transmitter Lamp Voltage Measurements Record, Figure 4-12.

LAMP ALIGNMENT

Loosen the objective lens set screw.

Align the transmitter telescope on a target at least one-quarter mile away. Adjust the position of the objective lens to bring the object into proper focus. Tighten the set screw securely.

To support annual operation of a transmissometer operating under the IMPROVE sampling protocol, (10-minute sample each hour) assign ten (10) lamps for use with this transmitter. Typically this will include the reference lamp previously assigned to this transmitter, any unused operational lamps previously assigned to this transmitter, and new lamps taken from stock. All new lamps must have been previously "burned in" as described in TI 4200-2110, *Transmissometer Lamp Preparation (Burn-in) Procedures*. Document the lamp numbers of the assigned lamps on the Optec LPV-2 Transmissometer Transmitter Lamp Voltage Measurements Record.

Place the lamp alignment disc over the front of the transmitter telescope. Insert the first assigned lamp into the transmitter and turn the transmitter on. If any part of the filament image projected onto the alignment disc is obscured, note the degree of misalignment.

Repeat the above procedure for all ten (10) of the assigned lamps.

Reinsert the lamp with the poorest alignment and realign the lamp using the following procedures.

- Loosen the four (4) screws that hold the lamp plate in place.
- Adjust the lamp plate position to center the projected filament image.
- Retighten the lamp plate screws.
- Recheck the alignment of the other lamps as described above.
- Repeat the above procedures until all lamps are properly aligned (full filament image projected onto alignment disc).

FILAMENT FOCUS

The filament focus is controlled by the position of the feedback block. Adjust the filament focus using the following procedures.

- Place a piece of opaque material (such as a Kimwipe) against the objective lens.
- Insert the first lamp in the transmitter and turn the transmitter on.
- Loosen the set screw that holds the feedback block in place.
- Adjust the position of the feedback block to provide the sharpest projected filament image.
- Tighten the feedback block set screw and recheck the focus.
- Check the focus for the remaining lamps with this feedback block position.
- Repeat the above procedures until the focus is optimized for all assigned lamps.

FEEDBACK BLOCK/LAMP CLEARANCE

The position of the feedback block must allow all lamps to be fully inserted without touching the flat lens of the feedback block. Check the clearance between the lamps and the feedback block using the following procedures.

- Place a Kimwipe between the feedback block flat lens and each lamp as the lamp is inserted into the lamp plate.
- If the Kimwipe is pinched in place when the lamp has been fully inserted, loosen the feedback block set screw and move the feedback block forward (towards the front of the telescope) just enough to permit the Kimwipe to be removed.
- Tighten the set screw and repeat the above procedures with each lamp.

LAMP VOLTAGE SETUP

The lamp voltage control circuit must be set up so that the maximum initial lamp voltage for all operational lamps assigned to a specific transmitter does not exceed 5.6 volts. Since the lamp voltage control circuit automatically adjusts lamp voltage based on the lamp brightness measured by the feedback block, lamp voltage must be checked for each lamp. The lamp voltage is then adjusted to 5.6 volts using the lamp with the highest lamp voltage during the initial check. Document all lamp voltage measurements on the Optec LPV-2 Transmissometer Transmitter Lamp Voltage Measurements Record.

Procedures for performing the initial lamp voltage check are as follows:

- Connect the 4 1/2 digit digital voltmeter (DVM) to the lamp voltage measurement pigtail on the transmitter cable.
- Set the DVM on the 20 VDC scale (this should give a measurement resolution of 1 mV).
- Insert the first lamp into the transmitter and turn the transmitter control box "ON."
- After the lamp has operated for fifteen (15) seconds, record the lamp voltage as measured by the DVM (5.xxx volts).
- Turn the transmitter control box "OFF" and remove the lamp. Let the lamp cool before placing it back in the lamp case.
- Repeat the above procedures for each lamp assigned to this transmitter.

Procedures for the final setup of operational lamp voltages are as follows:

- Identify the lamp with the highest lamp voltage during the initial lamp voltage check.
- Insert this lamp into the transmitter and turn the transmitter control box "ON."
- Monitor the lamp voltage with the DVM as in the initial lamp voltage check.
- The lamp voltage is controlled by potentiometer P2 on the transmitter control box circuit board (Refer to Figure 4-3). Adjust P2 for a lamp voltage of 5.6 VDC.
- Check the lamp voltage after the lamp has operated for approximately six (6) minutes. If the lamp voltage is not equal to 5.6 volts, ± 5 mV, readjust the lamp voltage to 5.6 VDC, turn the control box "OFF," let the lamp cool for five (5) minutes and repeat this step.
- When P2 has been adjusted so that the lamp with the highest initial check voltage is operating at a nominal voltage of 5.6 volts after six (6) minutes of operation, document the actual voltage and turn the control box "OFF."

- For each remaining lamp, insert the lamp in the transmitter, turn the control box "ON," and measure and record the lamp voltage after the lamp has operated for six (6) minutes. Be sure to let each lamp cool for several minutes before returning the lamp to the lamp case.
- When the reference lamp is being tested, the voltages at test points 1, 2, 3, and 4 should also be measured and recorded along with the final lamp voltage.

4.1.2.4 Transmitter Functional Test

TRANSMITTER POWER AND VOLTAGE MEASUREMENTS

All functional check measurements related to the transmitter are conducted with the reference lamp assigned to the instrument. Record the reference lamp serial number.

Measure and record the transmitter operating current with the lamp "ON."

Measure and record the lamp voltage using the measurement pigtail on the control box cable.

Measure and record the T1, T2, T3, T4, and T5 test point voltages on the transmitter control box circuit board (refer to Figure 4-3).

4.2.2 Receiver Servicing and Functional Tests

Servicing of the LPV-2 receiver includes:

- Cleaning of the receiver computer, telescope, detector head, all optical components, and all electrical connections.
- Inspection and evaluation of receiver optics quality.
- Physical adjustment and alignment of optical components.
- Replacement of expendable electrical components.
- Functional testing.

Completion of receiver servicing tasks is documented on page 3 of the Optec LPV-2 Transmissometer Servicing Checklist. Document results obtained during functional testing on page 4 of the servicing checklist. Procedures for performing and documenting specific tasks are described below.

4.2.2.1 Receiver Telescope Servicing

TELESCOPE EXTERIOR CLEANING

Clean the exterior of the receiver telescope with window cleaner and paper towels.

OBJECTIVE LENS CLEANING

Clean the objective lens assembly using the following procedures:

- The thumbscrew on the top of the telescope holds the objective lens assembly in place. The entire assembly is threaded to screw into the telescope tube. Remove the objective lens assembly by loosening the thumbscrew and unscrewing the assembly from the telescope tube.
- Remove the aperture ring by loosening the three Allen set screws that hold the ring in place.
- Put on a pair of cleaning gloves prior to removing the objective lens from the assembly. Carefully invert the assembly, letting the lens fall into your hand.
- Clean both sides of the lens with a cleaning cloth.
- Clean the lens seat and the aperture ring with window cleaner and paper towels.
- Reinsert the objective lens into the assembly, replace the aperture ring, and tighten the three Allen set screws that hold the aperture ring in place.

APERTURE DIAMETER

Record the aperture diameter inscribed on the front of the aperture ring.

BAFFLE

Check that the baffle is securely mounted. If it is not, remount it using black RTV silicone.

Measure the distance from the front of the telescope to the baffle. This distance should be 9 1/4 inches. If the distance is not 9 1/4 inches, record the measured distance in the comments section.

Tighten the screws that hold the wedge base in place.

TELESCOPE INTERIOR CLEANING

Using Kimwipes held in the jaws of a flexible pickup tool, clean the inside of the receiver telescope. Wipe back and forth to remove all contaminants. Use canned air to blow any remaining particles from the inside of the tube.

Reinstall the objective lens assembly in the telescope tube.

FOCUS QUALITY AND COLOR CORRECTION

Temporarily install the detector head for this receiver on the telescope.

Align the telescope on a target at least one-quarter mile away. adjust the position of the objective lens to bring the target into proper focus. Note the focus quality and color correction on the servicing form.

Tighten the thumbscrew that holds the assembly in place.

Remove the detector head from the receiver telescope.

FINAL ITEMS Cover both ends of the telescope with large plastic bags, secure the plastic bags with rubber bands, and place the entire telescope in a clean white cloth receiver telescope bag.

4.2.2.2 Receiver Detector Head Servicing

EXTERIOR CLEANING Clean the exterior of the receiver detector head with window cleaner and paper towels.

EYEPIECE CLEANING AND ADJUSTMENT Unscrew and remove the eyepiece lens. Clean both sides of the lens with an optical cleaning cloth.

Clean the eyepiece tube with canned air and replace the lens (finger-tight).

Adjust the eyepiece vertical position. Loosen the two set screws that hold the eyepiece in place. Align the bottom of the black band on the eyepiece with the top of the eyepiece holder and tighten the set screws.

FLIP MIRROR SERVICING Check the "ON" (green) and "OFF" (red) labels on the flip mirror control knob. If they are damaged or missing, they should be replaced.

Replace the flip mirror alarm battery using the following procedures:

- Remove the four (4) screws that hold the end plate in place.
- Remove the single set screw that holds the speaker screen in place.
- Remove the speaker screen and the sound tube.
- Slide the printed circuit board out of the alarm enclosure.
- Desolder the old battery. Obtain a new battery (BR-2325-2HC) and solder it onto the circuit board.
- Slide the circuit board back into the enclosure, replace the sound tube and speaker screen, tighten the speaker screen set screw, and replace the end plate.

FINAL ITEMS Clean the connector on the detector head cable with contact cleaner. Lubricate the plastic shell with silicone lubricant.

Secure the flip mirror in the "ON" position (alarm off) with a rubber band.

Coil the detector head cable and tie together with a rubber band.

Place the detector head into a large plastic bag and secure with a rubber band. Then place it into a clean white cloth detector head bag.

4.2.2.3 Receiver Computer Servicing

RECEIVER COMPUTER CLEANING

Clean the outside of the receiver computer with window cleaner and paper towels.

Remove the top cover of the receiver computer. Use canned air to clean the interior of the receiver computer.

Disconnect all internal connectors and remove the CIMBUS computer cards from the receiver computer card cage.

Clean the gold connector pins on the CIMBUS computer cards with gold contact cleaning spray. Clean the gold connector pins in the CIMBUS card cage with the gold contact spray.

Clean all other receiver computer internal connections with contact cleaner.

Reinstall the CIMBUS computer cards in the card cage. Secure the cards using the rubber band hold downs.

Clean the bandpass circuit board with canned air. Clean connector contacts with contact cleaner and check the integrity of the connectors.

Clean the power supply module connector contacts with contact cleaner and check the integrity of the connectors.

Replace the power supply fuse (AGC 1A fast blow)

Inspect the battery clips on the front panel circuit board. Check for cold solder joints and repair as required. Clean the battery clips with contact cleaner.

4.2.2.4 Receiver Functional Tests

RECEIVER COMPUTER SETUP

Connect the receiver detector head to the receiver computer and connect the receiver computer to a 0-12 VDC variable output power supply. Set the power supply output to 12 VDC. Set the "A1" switch to position **C** (raw readings), the "CYCLE" switch to **CONT** (continuous), and the "INTEG" switch to **1** (one minute).

Position the detector head so that it is "looking" at the transmitter lamp through a pin-hole mask. Adjust the detector head position so that the one-minute raw readings measured by the receiver computer are greater than 0.2 volts (200 on the receiver computer display).

Connect channel 1 and channel 2 of the oscilloscope to "TP1" and "TP2" of the auto reset circuit located on the receiver computer front panel board (refer to Figure 4-4).

POWER-UP TEST

Turn the receiver computer on and record the display reading immediately following the instruments power-up cycle.

ZERO INPUT TEST

Set the receiver telescope flip mirror to the "OFF" position (light blocked). Turn the receiver computer **OFF**, wait five (5) seconds and turn the receiver computer back **ON**. After one minute, the receiver computer will update the data on the front panel display. Since the flip mirror blocks all light from reaching the detector, the display should read "000." Record the display reading.

POWER SUPPLY AND AUTO RESET TEST

Place the receiver flip mirror in the "ON" position. With the power supply output set at 12 VDC, measure and record the receiver computer internal power supply outputs (+5 VDC, +15 VDC, -15 VDC). These voltages should be measured at the test points on the power supply board (refer to Figure 4-5). After the display

updates,

measure and record the "A1" output and the receiver operating current.

Reduce the external power supply voltage to 8.0 volts. After the next full one-minute update, record the "A1" output. Record the receiver power supply output voltages, the "A1" output, and the "TP1" and "TP2" logic levels (high or low). This test confirms that the instrument will operate properly with a supply voltage as low as 8.0 volts.

Reduce the external power supply voltage to 7.0 volts. "TP1" and "TP2" should both go to a logic low. The receiver front panel display should be blank and the "A1" output should be zero. These conditions indicate that the receiver computer has ceased operation. Record the power supply output voltages, the "A1" output, and the "TP1" and "TP2" logic levels.

Increase the external power supply voltage to 12.0 volts. If the auto reset circuit is functioning properly, "TP1" and "TP2" will return to a logic high level immediately after the power supply voltage is increased. The "A1" output will be zero until the first update. After the update the "A1" output will return to the value measured at the start of this test. At this time record the power supply output voltages, the "A1" output, and the "TP1" and "TP2" logic levels.

BANDPASS BOARD ZERO-CROSS DETECTOR SYNCRO-NIZATION

The purpose of this test is to determine if the receiver bandpass circuit zero-cross detector output is synchronized with the incoming transmitter signal. Connect channels 1 and 2 of the oscilloscope to test points "TP4" and "TP5" of the receiver computer bandpass board. Synchronize the oscilloscope on channel 1. If the synchronization circuit is functioning properly, both the leading and trailing edges of the two waveforms will be in phase. If the waveforms are not synchronized, adjust potentiometer "P1" on the bandpass board (refer to Figure 4-6, Bandpass Board Component Diagram).

4.2.2.5 Serial Card Tests

SERIAL CARD TEST SETUP

software

Turn the receiver computer **OFF** and insert the CIMBUS serial card into slot #7 of the CIMBUS computer. Connect the serial card output to the serial port on the PC computer. PROCOMM

is used to communicate with the CIMBUS computer. Turn the receiver computer **ON** and enter **TEST** to initiate the receiver computer self-test program.

The "TEST" program will execute a fixed sequence of test routines that will check all major receiver computer functions. When one test is completed, hit any key to move to the next test in the sequence. Figure 4-7 shows the receiver computer front panel digital display, switches and status lamps. Record the result (Pass/Fail) for each test listed below on the inspection checklist. If instrument fails any portion of a test, briefly describe the observed failure(s) under "Comments."

TOGGLE TEST

The "TOGGLE" lamp, located on the receiver computer front panel will blink continuously.

OVER RANGE (OR) TEST

The over range (OR), located on the receiver computer front panel will blink continuously.

CAL SWITCH CHECK

The "CAL" switch is a three (3) digit thumbwheel switch located on the receiver computer front panel. The number set into this switch will be displayed on the computer screen. The number displayed on the screen will update each time any digit on the switch is changed. Verify that all 10 positions (0-9) for each digit are translated properly by the receiver computer.

PATH SWITCH CHECK

The "PATH" switch is a four (4) digit thumbwheel switch located on the receiver computer front panel. Follow the switch test procedures described above for the "CAL" switch.

A1 SWITCH TEST

The "A1" switch is a three (3) position rotary switch located on the front panel of the receiver computer. Set the "A1" switch to each of the three positions (C,B,VR). The "TEST" program will continuously read the switch setting and display the setting as a number (C=0, B=1, VR=2) on the computer screen. Verify that the number displayed matches the switch setting for each switch position.

A2 SWITCH
TEST

The "A2" switch is a two (2) position rotary switch located on the front panel of the receiver computer. Follow the procedures described above for testing the "A1" switch. The "A2" switch positions and the corresponding numbers displayed on the computer screen are "SD" (0) and "CR" (1).

D/A
CONVERTER
CALIBRATION

The receiver computer output test fixture includes a mating connector for the receiver computer output connector. This test fixture provides a switchable connection between the voltmeter and each of the receiver computers two analog output signals (refer to Figure 4-8, Receiver Computer Output Text Fixture).

Turn the receiver computer **OFF** and remove the D/A converter board from the CIMBUS card cage. Insert the CIMBUS extender card in the D/A converter slot and plug the D/A converter into the extender card. Use the extension cables to make the connection from the wiring harness to the D/A connectors. Turn the receiver computer **ON**.

The "TEST" program provides three prompts indicating the test input applied to the D/A converters that generate the "A1" and "A2" output voltages. The test program also specifies the potentiometers to be adjusted for recalibration (see Figure 4-13, CIMBUS D/A Converter Circuit Board Components Diagram, for the location of the adjustment potentiometers).

The calibration prompts and corresponding output voltages expected are:

- ZERO - 0.00 volts
- MAX (Full scale) - 9.9975 volts
- MID (Half scale) - 4.9988 volts

The corresponding readings expected on the receiver computer display (for all "A1" switch positions) are:

- ZERO - 000
- MAX (Full scale) - 1000
- MID (Half scale) - 500

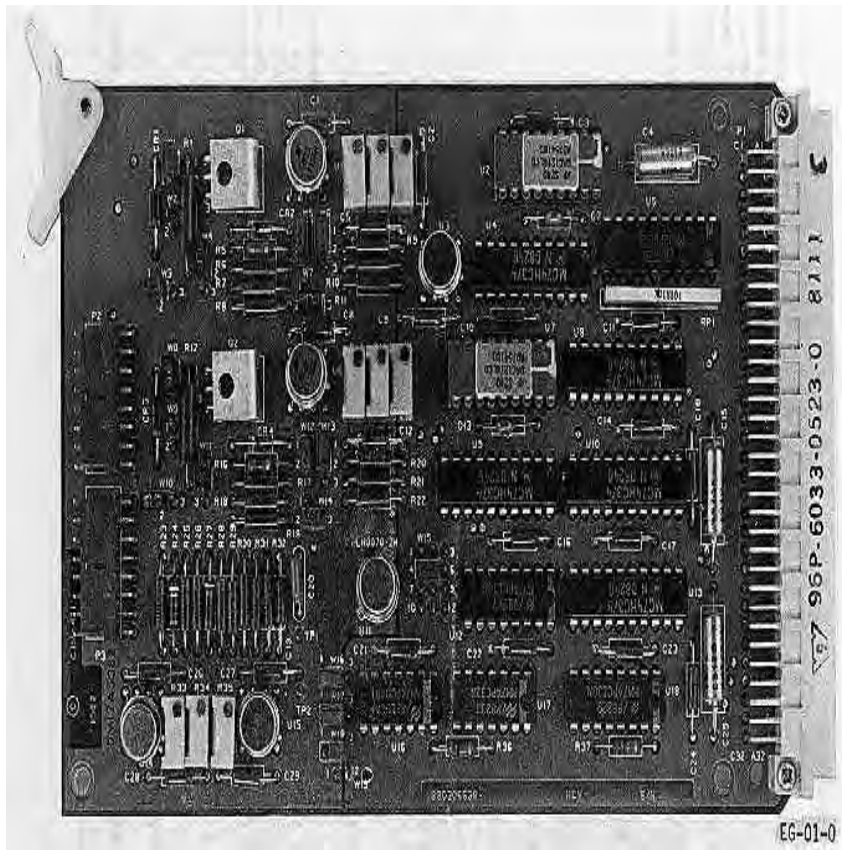
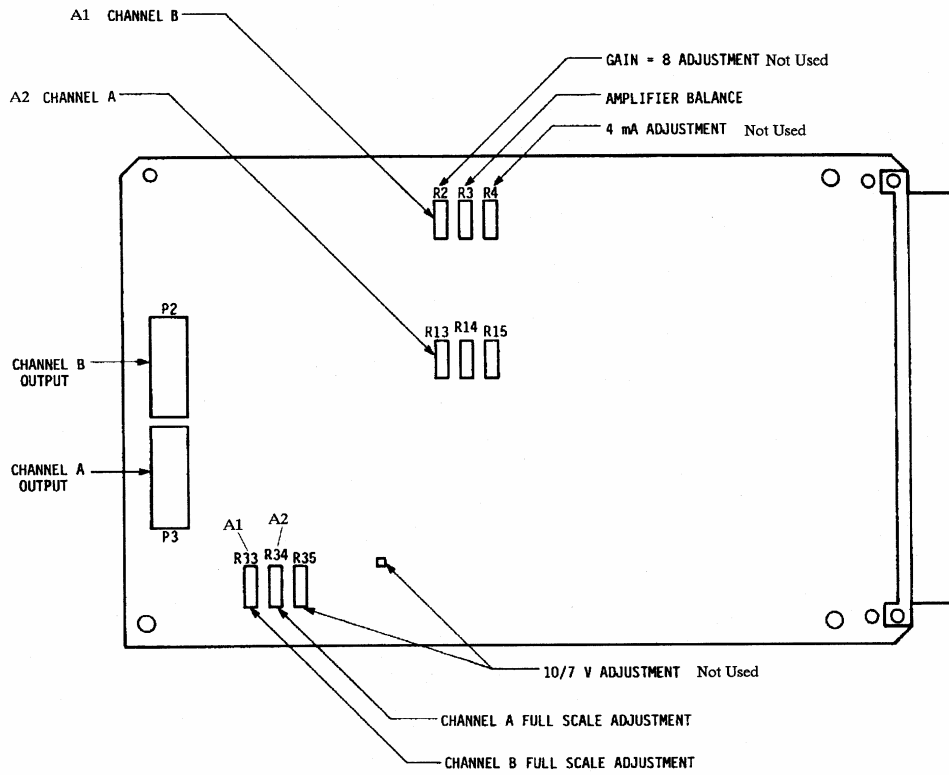

Figure 4-13. CIMBUS D/A Converter Circuit Board Components Diagram.

Procedures for recalibrating the receiver computer analog output channels are as follows:

- Go to the "ZERO" prompt in the "TEST" program.
- Set the test fixture switch to the "A1" position and adjust "R3" on the D/A card for an output of 0.000 VDC.
- Record the receiver computer display reading and the DVM reading on the servicing checklist.
- Set the test fixture switch to the "A2" position and adjust "R14" on the D/A converter board for an output of 0.000 VDC.
- Record the DVM reading on the servicing checklist.
- Go to the "MAX" prompt in the "TEST" program.
- Set the test fixture switch to the "A1" position and adjust "R33" on the D/A card for an output of 9.9975 ± 0.0005 VDC.
- Record the receiver computer display reading and the DVM reading on the servicing checklist.
- Set the test fixture switch to the "A2" position and adjust "R34" on the D/A card for an output of 9.9975 ± 0.0005 VDC.
- Record the DVM reading on the servicing checklist.
- Adjust "P5" on the receiver computer front panel board (refer to Figure 4-4) for a receiver computer display reading of "1000."
- Go to the "MID" prompt in the TEST program.
- Set the test fixture switch to the "A1" position.
- Record the receiver computer display reading and the DVM reading on the servicing checklist.
- Set the test fixture switch to the "A2" position.
- Record the DVM reading on the servicing checklist.

4.2.2.6 Toggle Voltage Test

The receiver computer toggle output voltage is measured with and without an output load. The receiver computer output test fixture is used for this test. The "TOG-NL" (Toggle, no-load) position connects the toggle output directly to the voltmeter. The "TOG-L" (Toggle, with load) position connects a 4700 ohm resistor in parallel with the voltmeter input.

MEASURE
VOLTAGES

Set the receiver computer for continuous operation ("CYCLE" switch on **C**) and one minute integrations ("INTEG" switch on **1**). Measure the toggle output voltage in both the "TOG-NL" and "TOG-L" positions with the toggle lamp "ON." Wait one minute for the toggle lamp to switch "OFF" and repeat the measurements. Record the measured voltages for each set of conditions.

4.2.2.7 Receiver Computer Gain Test

MEASURE
EMULATOR
OUTPUT
VOLTAGE

Disconnect the detector head output cable from the receiver computer and connect the detector head emulator in its place. The detector head emulator is powered by the receiver computer and generates a low level square wave signal that emulates the detector head output response under operational conditions. Connect the receiver computer output test fixture to the receiver computer output connector. Set the emulator switch to position "2" and measure the emulator output voltage using an rms voltmeter.

MEASURE
RECEIVER
COMPUTER
OUTPUT

With the receiver computer set for continuous operation and one-minute integrations, measure the receiver computer output for gain switch settings of "100," "300," and "500." Record the emulator output voltage and the three receiver computer output voltages. Reset the emulator switch to position "1" and repeat the above procedure for gain switch settings of "700" and "900."

4.2.3 Transmitter/Receiver Optical Alignment

Pre-field alignment of the transmissometer optics is required following annual servicing of the instrument and includes:

- Transmitter alignment.
- Receiver detector alignment.
- Receiver output detector check.

Pre-field alignment requires the same optical and electronic test equipment as specified for the post-field alignment checks (Refer to Section 4.1.3, Post-Field Alignment Checks). The basic procedures parallel the post-field alignment check procedures. The post-field procedures go only as far as measuring the parameters that can identify optical alignment problems that could affect data collected while the instrument was operating in the field. The pre-field alignment includes additional procedures for realigning the optics to optimize the instrument performance.

The Optec LPV-2 Transmissometer Pre-Field Alignment Form, Figure 4-14, is used for documenting all pre-field alignment checks and measurements.

OPTEC LPV-2 TRANSMISSOMETER
PRE-FIELD ALIGNMENT CHECK

Instrument Number: _____
Date: _____
Technician: _____

1. TRANSMITTER ALIGNMENT CHECK

Focus the transmitter on the target (shown to the right of this paragraph) and tighten the objective lens securely. Adjust the transmitter so the beam is inside the large outer circle of the target. The target has two inner circles. The larger inner circle represents the outer limit for the reticle. The smaller inner circle represents the ideal reticle alignment. Draw the actual reticle position on the target. If the reticle is not within limits, realign the transmitter. Draw the final reticle position on the target diagram.

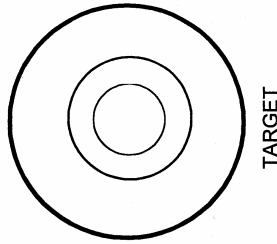

FULL RETICLE ALIGNMENT

Alignment Position	1	2	3	4	5	Maximum
Pre-align Readings	_____	_____	_____	_____	_____	_____
Post-align Readings	_____	_____	_____	_____	_____	_____

1/4 RETICLE ALIGNMENT

Alignment Position	1	6	7	8	9
Pre-align Readings	_____	_____	_____	_____	_____
Post-align Readings	_____	_____	_____	_____	_____

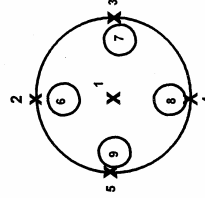

ALIGNMENT POSITIONS

3. RECEIVER DETECTOR OUTPUT CHECK

Adjust Light Source Intensity for a Reference Detector Output of Approximately 7.0 Volts

Reference Detector Output at Alignment Position 1: _____

Test Detector Output at Alignment Position 1: _____

prefld.sam (8/96)

Figure 4-14. Optec LPV-2 Transmissometer Pre-Field Alignment Form.

4.2.3.1 Transmitter Alignment Check

This procedure requires an unobstructed sight path of at least 50 feet and the following equipment:

- Tripod with Optec alti-azimuth base
- Spotting scope mounted on a tripod
- Transmitter alignment target
- DC power supply - 12 volts @ 5 amps

EQUIPMENT SETUP

Attach the transmitter alignment target to a wall at one end of the sight path. The center of the target should be at a height of approximately 42 inches. Attach the transmitter telescope to the tripod and set up the tripod 47 feet from the alignment target. Set up the spotting scope next to the transmitter telescope. Focus the transmitter telescope on the alignment target by adjusting the position of the objective lens. The objective lens is held in position by a set screw in the top of the telescope.

ADJUST ALIGNMENT

Connect the DC power supply to the transmitter control box and connect the control box to the transmitter telescope. Insert the reference lamp for the instrument being tested into the transmitter and turn the transmitter "ON." Use the spotting scope to observe the position of the transmitter light beam while adjusting the alti-azimuth base to center the light beam in the large outer circle of the alignment target. The transmitter reticle should align with the smallest of the two inner circles (refer to the target diagram on the Optec LPV-2 Transmissometer Pre-Field Alignment Form). Alignment is acceptable if the reticle position is entirely within the larger of the two inner circles. If the reticle position is not within the larger of the two inner circles, realign the transmitter using the following procedures:

- Remove the telescope tube from the flip mirror housing by loosening the two (2) set screws on the top and side of the housing next to the telescope.
- Loosen the three (3) alignment screws located at the front of the flip mirror housing. These Allen screws extend through the housing to the lamp chamber. They should be loosened only enough to allow the flip mirror housing to be adjusted without slipping.
- Replace the telescope tube and align the light beam on the target.
- While looking through the eyepiece, adjust the flip mirror housing so that the reticle is aligned with the target.

- Check the light beam position on the target. If it is not aligned within the outer circle, adjust the lamp housing as required to place the light beam entirely within the circle.
- Recheck the reticle position. If the reticle is not properly aligned, readjust the flip mirror housing and the lamp housing as described in the previous two steps. Repeat this procedure until both the light beam and reticle are properly aligned.
- Remove the telescope, tighten the three alignment screws, and replace the telescope.
- Recheck the transmitter alignment to ensure that alignment was maintained as the instrument was reassembled. If the alignment is not within specifications, the entire alignment procedure must be repeated.
- When the alignment is finally within specifications, sketch the outline of the actual reticle position on the target diagram.

4.2.3.2 Receiver Detector Alignment

Receiver detector alignment (part 2 of the Optec LPV-2 Transmissometer Pre-Field Alignment Form) is performed in two (2) stages. For the first stage, the size of the light beam projected onto the detector is adjusted to the diameter of the receiver reticle (full reticle light beam). The detector response is measured with the light beam centered in the reticle (position 1) and centered on the edge of the reticle at 0°, 90°, 180°, and 270° (positions 2-5). These alignment positions are shown on the drawing labelled "Alignment Positions" on the pre-field alignment form. The beam position is then scanned across the reticle to identify the position that provides the maximum output from the detector. Procedures for the second stage are similar to those described above with the light beam diameter adjusted to 1/4 of the reticle diameter (1/4 reticle light beam). Detector output measurements are obtained with the light beam centered in the reticle (position 1) and adjacent to the reticle at 0°, 90°, 180°, and 270° (positions 6-9). All measurements are documented on the Optec LPV-2 Transmissometer Pre-Field Alignment Form.

This procedure requires the following test equipment:

- Optical bench
- Variable intensity light source
- Beam diverter
- 135 mm camera lens
- Detector head alignment fixture
- Receiver computer emulator
- Digital voltmeter (4 1/2 digit)

OPTICAL
BENCH
SETUP

To perform the full reticle light beam alignment check, the optical bench should be setup with the following accessories installed at the position shown:

- Variable intensity light source - 0.0 cm
- Beam diverter - 15.0 cm
- 135 mm camera lens - 37.5 cm
- Detector head alignment fixture - 63.5 cm

DETECTOR
HEAD
SETUP

Set up the detector head and test equipment as follows:

- Install the detector head being tested on the detector head alignment fixture.
- Connect the detector head cable to the receiver computer emulator.
- Connect the digital voltmeter to the output of the receiver computer emulator.
- Place the pin-hole mask in the light source filter holder.
- Set camera lens aperture at $f/2.8$

ADJUST
BEAM
DIVERTER

Turn the light source "ON" and adjust the beam diverter to center the light beam in the detector head reticle. If the light beam is slightly out of focus, adjust the position of the detector head alignment fixture as needed to bring the light beam into focus.

ALIGN
RETICLE
LIGHT BEAM

Using the beam diverter to adjust the light beam position, align the full reticle light beam to alignment positions 1-5 as indicated on the pre-field alignment form. Record the detector output voltage at each position. Then, align the light beam for maximum detector output voltage. Align the light beam to give the maximum detector output voltage and record this value on the alignment form. If the maximum is not at position 1, use the following procedures to align the reticle with the detector:

- Center the light beam in the receiver telescope reticle (position 1).
- Adjust the detector alignment to move the maximum towards position 1. The detector alignment is controlled by four set screws (top, bottom, and both sides) located directly behind the detector head eyepiece. Changes in vertical alignment are accomplished by adjusting the top and bottom screws as a pair (loosening one screw and tightening the other). Horizontal alignment changes are accomplished in the same manner with the set screws on the sides of the assembly.

- Check the location of the realigned maximum output.
- Repeat the above procedure until the maximum output occurs at position 1.
- When the maximum output is obtained at position 1, record the detector output for positions 1-5 and at the maximum.

CHANGE
SETUP

Prior to performing the 1/4 reticle alignment check, the optical bench setup must be changed as follows:

- Position the 135 mm camera lens at 55.5 cm
- Position the detector head alignment fixture at 65.0 cm
- Set the camera lens aperture at f/4.

ALIGN
RETICLE
LIGHT BEAM

Align the 1/4 reticle light beam to the center of the reticle (position 1) and each of the four (4) alignment positions adjacent to the edge of the reticle (positions 6-9). Record the detector output voltage at each position. If the readings at opposite positions (6 and 8 or 7 and 9) differ by more than 2%, the detector alignment should be adjusted using the following half-power method procedures:

- Align the 1/4 reticle light beam at position 1 and note the detector output voltage at this position.
- Monitor the detector output while adjusting the beam diverter to move the light beam vertically towards position 2. When the detector output voltage decreases to 50% of the voltage measured in the previous step, record the light beam position.
- Adjust the light beam towards position 4 and again record the position of the light beam where the detector output voltage decreases to 50% of the position 1 value.
- If the two 50% positions are not equidistant from position 1, adjust the alignment of the detector following the procedures described in the full-reticle alignment procedures.
- Repeat the above three steps moving the light beam towards positions 3 and 5 to determine the 50% output positions along the horizontal axis.
- Repeat the 1/4 reticle alignment check, recording the detector output at position 1 and positions 6-9. If each of the voltages measured at positions 6-9 are not within 1% of the voltage measured at position 1, the half-power alignment procedure should be repeated.

4.2.3.3 Receiver Detector Output Check

The receiver detector output check establishes a relative output relationship with the reference detector head. The light source intensity is adjusted to provide a specified output voltage from the reference detector. The test detector is then subjected to the same light source under the same conditions and its output voltage documented. Since instruments are serviced on an annual basis, this output check provides a history of the detector sensitivity.

The initial setup for the optical bench and test equipment is the same for this check as for the full reticle alignment check. Procedures for performing the output check are as follows:

- Center the light beam in the reference detector head reticle (align to alignment position 1).
- Adjust the light intensity for a detector output voltage of approximately 7.0 volts.
- Document the actual output voltage of the reference detector head.
- Replace the reference detector head with the test detector head.
- Without adjusting the light intensity, align the light beam to position 1 in the test detector head. Document detector head output voltage on the alignment form.

4.3 PRE-FIELD CALIBRATION

A pre-field calibration must be performed prior to sending an instrument to the field. Detailed instructions for performing and documenting pre-field calibrations are provided in TI 4200-2100, *Calibration of LPV-2 Transmissometers (IMPROVE Protocol)*.

5.0 REFERENCES

Optec, Inc., 1991, Model LPV Long Path Visibility Transmissometer, Version 2, Technical Manual for Theory of Operation and Operating Procedures, July, Lowell, MI.

National Semiconductor Corp, 1983, CIM-660 Firmware Monitor User's Manual, August. Santa Clara, CA.

National Semiconductor Corp, 1982, CIM-801/-802/-804 CPU Board Hardware Reference Manual, May. Santa Clara, CA.

National Semiconductor Corp, 1984, CIM-110/-114/-118 and CIM-110C/-114C/-118C Universal Memory Expansion Boards Hardware Reference Manual, March, Santa Clara, CA.

National Semiconductor Corp, 1983, CIM-210/-210C Parallel I/O Board Hardware Reference Manual, June, Santa Clara, CA.

National Semiconductor Corp, 1984, CIM-415/-415C Analog Input Board Hardware Reference Manual, September, Santa Clara, CA.

National Semiconductor Corp, 1983, CIM-421/-441C Analog Output Board Hardware Reference Manual, March, Santa Clara, CA.

National Semiconductor Corp, 1984, CIM-203/-203C Serial I/O Board Hardware Reference Manual, March, Santa Clara, CA.

National Semiconductor Corp, 1984, CIM-602/604 Card Cages User's Manual, December, Santa Clara, CA.